

CITEL



По вопросам продаж и поддержки обращайтесь:

Алматы (7273)495-231
Архангельск (8182)63-90-72
Астрахань (8512)99-46-04
Барнаул (3852)73-04-60
Белгород (4722)40-23-64
Брянск (4832)59-03-52
Владивосток (423)249-28-31
Волгоград (844)278-03-48
Вологда (8172)26-41-59
Воронеж (473)204-51-73
Екатеринбург (343)384-55-89
Иваново (4932)77-34-06
Ижевск (3412)26-03-58
Иркутск (395)279-98-46
Россия (495)268-04-70

Казань (843)206-01-48
Калининград (4012)72-03-81
Калуга (4842)92-23-67
Кемерово (3842)65-04-62
Киров (8332)68-02-04
Краснодар (861)203-40-90
Красноярск (391)204-63-61
Курск (4712)77-13-04
Липецк (4742)52-20-81
Магнитогорск (3519)55-03-13
Москва (495)268-04-70
Мурманск (8152)59-64-93
Набережные Челны (8552)20-53-41
Нижний Новгород (831)429-08-12
Киргизия (996)312-96-26-47

Новокузнецк (3843)20-46-81
Новосибирск (383)227-86-73
Омск (3812)21-46-40
Орел (4862)44-53-42
Оренбург (3532)37-68-04
Пенза (8412)22-31-16
Пермь (342)205-81-47
Ростов-на-Дону (863)308-18-15
Рязань (4912)46-61-64
Самара (846)206-03-16
Санкт-Петербург (812)309-46-40
Саратов (845)249-38-78
Севастополь (8692)22-31-93
Симферополь (3652)67-13-56
Казахстан (7172)727-132

Смоленск (4812)29-41-54
Сочи (862)225-72-31
Ставрополь (8652)20-65-13
Сургут (3462)77-98-35
Тверь (4822)63-31-35
Томск (3822)98-41-53
Тула (4872)74-02-29
Тюмень (3452)66-21-18
Ульяновск (8422)24-23-59
Уфа (347)229-48-12
Хабаровск (4212)92-98-04
Челябинск (351)202-03-61
Череповец (8202)49-02-64
Ярославль (4852)69-52-93



DIN RAIL AC POWER SURGE PROTECTORS



DIN RAIL DC POWER SURGE PROTECTORS



AC POWER SURGE PROTECTION PANELS



LED SYSTEM SURGE PROTECTORS



PHOTOVOLTAIC SURGE PROTECTORS



TELECOM & DATA LINE SURGE PROTECTORS



COMPUTER NETWORK SURGE PROTECTORS



HIGH FREQUENCY COAXIAL SURGE PROTECTORS



GAS DISCHARGE TUBES



MISCELLANEOUS

THE SPECIALIST IN OVERVOLTAGE PROTECTION

With a thorough understanding of local standards and regulations, along with continuous investment in R&D, CITELE designs, manufactures and sells millions of SPD's each year.

CITELE develops many critical protection components internally. Our teams all over the world are proud to help bring the market a comprehensive product range of surge protectors with our unique client-focused service & quality.

CITELE's only business and expertise is to protect networks and equipment from transient overvoltages, in particular those induced by lightning. For this, CITELE manufactures two complementary products lines:

- **Gas discharge tubes** (or GDTs) are the basic passive components used to protect telephone exchanges and equipment from voltage surges; they are generally installed on telephone networks by telecommunication operators.

- **Surge Protection Devices** (or SPDs) are units combining several protection components. They may be used by the installer or by the end customer. They are designed to be incorporated in an installation to protect all electric, electronic, and data-processing equipment from transient overvoltages.

CITELE: best-in-class service quality

From the technical expertise to the operational deployment, we are passionate about all aspects and topics related to SPDs.

Our teams are composed of engineers and SPD specialists who can bring forward the best insights and solutions. Our technical and sales teams around the world are organized to share experience and knowledge.

Our teams place the user at the heart of their practise. Providing advice and training to their clients, they strive to bring the most appropriate product solution. Our local teams master both the language and the market specifics.

Our logistic: flexible, trustworthy and committed, reassures our customers.



OURS MEANS OF TESTS

3 LABORATORIES...

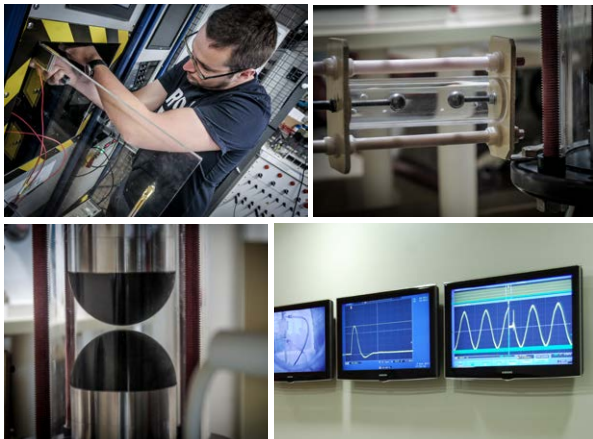

CITEL constantly pioneers new technologies thanks to a bold innovation strategy, high-level R&D and in-house regional test labs around the world.

CITEL is recognized as an industry leader that is instrumental in the development of international codes and standards.

In order to test its products internally for standards compliance and to evolve toward greater reliability CITEL has several centers of expertise and research (France, USA, China) equipped with :

- Various transient surge current and surge voltage generators such as 8/20, 10/350, 10/1000, 1.2/50...
- AC and DC Power Sources for short circuit and load current tests with possible superimposed and synchronized pulses for AC sources.
- Various equipment's for environmental tests (impact, vibration, climate, damp, fire...)

The G100K test generator in Reims (France) can produce exceptionally high impulse current of 100 kA and is used for testing structural lightning protection systems as well as Type 1 surge protectors.

Tests capacities are dedicated to electrical equipment generally and specifically to surge protection. We are using the following standards :

- IEC/ EN 61643-XXY
-11, -21, -31 and -41*
-311 and -331
- IEC/EN 610004-5
- NFC 17-100 and -102
- NF EN 50164-6 and IEC 62561-6 (as well as all the tests in surge currents pulses of these series of standards)
- UL1449, UL497B, UL497E
- ITU K12
- IEEE C62.31, C62.33, C62.35, C62.45
- ANSI C136.2
- etc...



Test facilities and benches are made to be polyvalent and CITEL teams of experts can also realize custom-made tests (out of standards)

In 2017, Shanghai lab has been equipped with a very high energy surge generator able to produce 240 kA in 8/20 μ s impulse.

Since 2019, our Shanghai Laboratory has received a CERTIFICATE OF APPROVAL for Customer's Testing Facility, for the testing of electrotechnical equipment and components under the IECEE System.

It has been approved by Dekra at Stage 2.

AN INTERNATIONAL NETWORK....

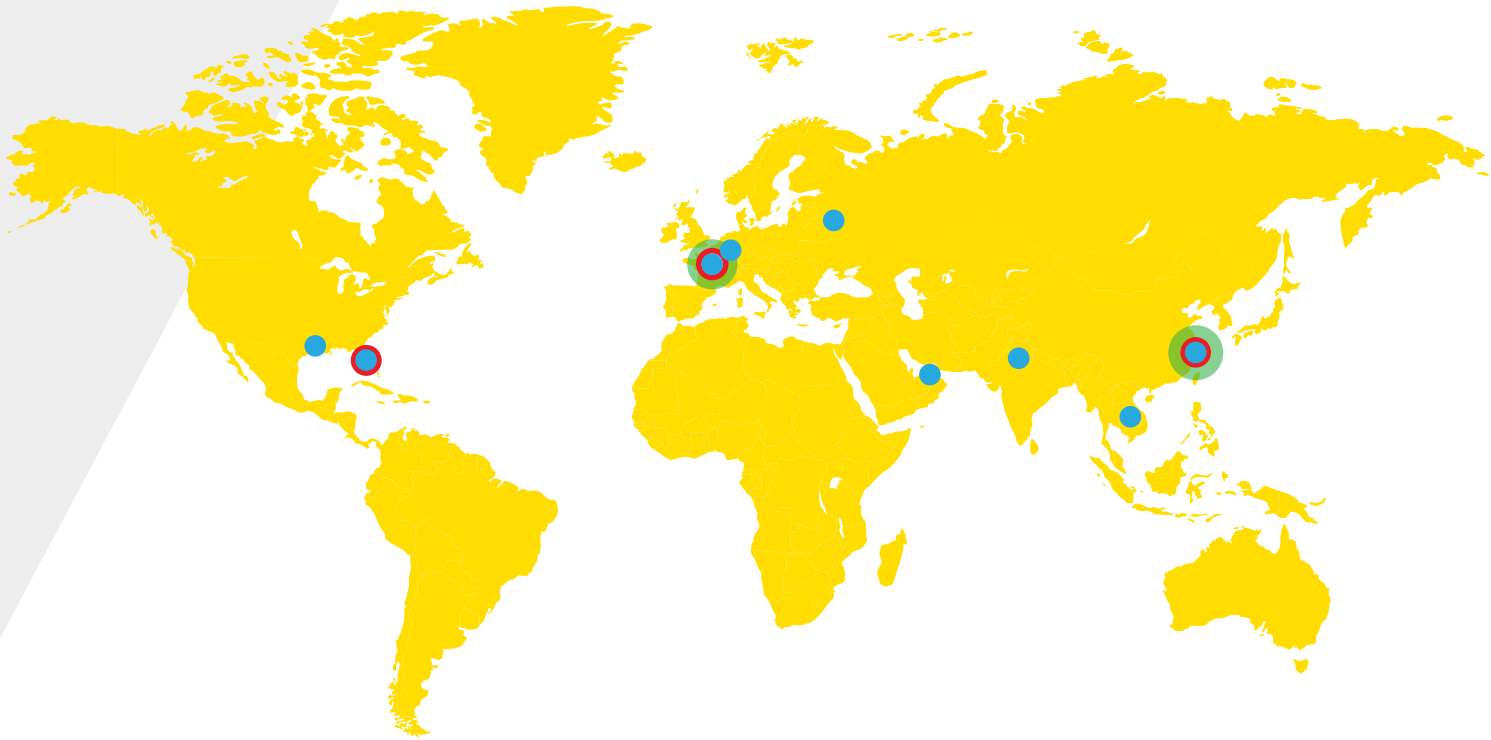

 Production & Tests Laboratories







 Factories

 Subsidiaries

-  **France - Sèvres**
Headquarters
 - General management
 - Administrative and Financial Department
 - Sales division : France and Export
 - Communication & Marketing Department

-  **France - Reims**
Production and Shipment
Research and Development

SUBSIDIARIES

-  **Citel Electronics GmbH**
Bochum (Germany)
-  **Citel Inc.**
Miramar (USA)
-  **Shanghai Citel Electronics Co., Ltd**
Shanghai (China)
-  **OOO Citel Vostok**
Moscow (Russia)
-  **Citel India**
New Delhi (India)
-  **Citel Thailand**
Bangkok (Thailand)
-  **Citel Middle East**
Dubai (United Arab Emirats)

....FOR OVER 80 YEARS



1944
Manufacture of the
first surge arrester

1988
1st AC modular
surge protector

1997
- AC surge protector new range «DS» series
- VG technology for AC surge protector

2012
Implementation of
a test laboratory in Reims

2017
New test laboratory 240 kA
in CITEL Shanghai

2019
AC / DC
new range

 **1937**
CITEL founded

 **1985**
CITEL USA

 **1988**
CITEL Germany

 **1992**
Reims factory

 **1996**
CITEL Shanghai

 **2010**
CITEL Russia

 **2012**
CITEL India

 **2017**
CITEL Thailand

 **2021**
CITEL Middle East

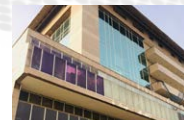

CITEL PROTECTS OUR PLANET



Besides our constant work on the quality of our products, we take into account the ecological issues of our planet.

This is why CITEL is working to optimize its production equipment in order to reduce the impact on the environment. We have chosen for our new range high quality raw materials.

Our products use **Halogen free** material and comply with **RoHS** regulations.
CITEL is **ISO 14001** certified and meet the requirements of the **WEEE** directive.

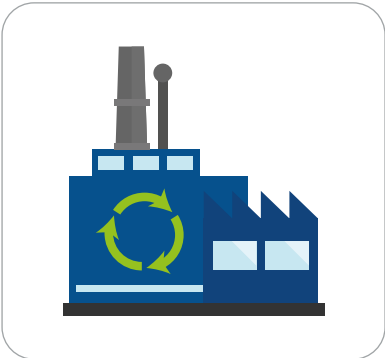

PRODUCTION RESPECTING ENVIRONMENTAL STANDARDS



PURCHASE OF MATERIALS COMPLIANT WITH THE ENVIRONMENTAL REGULATIONS



COMMITMENT FOR RECYCLING

TRANSIENT OVERVOLTAGES

An electrical network generally has a normal voltage: we also speak of nominal voltage. The network can be accidentally brought to a voltage higher than its nominal voltage: this is called overvoltage or surge voltage, if this one is very short. One of the possible causes of electrical or electronic equipment failure are the surge voltages .

WHAT IS THE ORIGIN OF AN SURGE VOLTAGE ?

Surge voltages differ in amplitude, duration and frequency. While protection against power surges caused by lightning or switching will require the use of surge protective devices (SPD), «ESD» or «LEMN» issues are far more specific and require other adapted solutions.

SURGE VOLTAGE DUE TO LIGHTNING STRIKE

The users of electric, electronic equipment and telephone and data-processing systems must face the problem of keeping this equipment in operation in spite of the transient overvoltages induced by lightning.

Lightning, investigated since Benjamin Franklin's first research in 1749, has paradoxically become a growing threat to our highly electronic society.

Lightning formation

A lightning flash is generated between two zones of opposite charge, typically between two storm clouds or between one cloud and the ground. The flash may travel several miles, advancing toward the ground in successive leaps: the leader creates a highly ionized channel. When it reaches the ground, the real flash or return stroke takes place.

A current in the tens of thousands of Amperes will then travel from ground to cloud or vice versa via the ionized channel.



Direct effects of lightning

At the moment of the discharge, there is an impulse current flow that ranges from 5,000 to 200,000 Ampere peak, with a rise time of about few microseconds.

- Impact on buildings: Falling objects, property damages, fire starts
- Impact on living beings: Lightning strike mortality of 10,000 people per year worldwide and from 10 to 20 people per year in France
- Phenomenon of step tension: Lightning can indirectly kill by striking nearby: in fact around the point of impact it creates a displacement of electric charges with a certain electric potential. The difference in potential (voltage) between two points is even greater as the difference between these two points is great. The higher this voltage, the more intense current can circulate in a living organism (electrocution) by the members in contact with the ground. This phenomenon is called "step tension", higher for a large quadruped oriented towards the point of impact, than for a human being. Thousands heads of cattle are victims of lightning each year.

This direct effect may be considered as a small factor in damaging electric and electronic systems, because it is highly localized.

The best protection is still the classic lightning rod or Lightning Protection System (LPS), designed to capture the discharge current and conduct it to a particular point.

Indirect effects of lightning

Impact on overhead lines

Such lines are very exposed and may be struck directly by lightning, which will first partially or completely destroy the cables, then cause high surge voltages that travel naturally along the conductors to line-connected equipment. The extent of the damage depends on the distance between the strike and the equipment.

Rise in ground potential

The flow of lightning in the ground causes earth potential increases that vary according to the current intensity and the local earth impedance. In an installation that may be connected to several grounds (e.g. a link between buildings), a strike will cause a very large potential difference and equipment connected to the affected networks will be destroyed or severely disrupted.

Electromagnetic radiation

The flash may be regarded as an antenna several miles high carrying an impulse current of several tenths of kilo-amperes, radiating intense electromagnetic fields (several kV/m at more than 1 km). These fields induce strong voltages and currents in lines near or on equipment. The values depend on the distance from the flash and the properties of the link.

Direct impact



Rise in ground potential



Impact on overhead lines



Coupling by radiation



INDUSTRIAL AND SWITCHING SURGES

This term covers phenomena caused by switching electric power sources on or off.

Surges due to switching operations are caused by:

- Starting motors or transformers
- Neon and sodium light starters
- Switching power networks
- Switch «bounce» in an inductive circuit
- Operation of fuses and circuit-breakers
- Falling power lines...

These phenomena generate transients of several kV with rise times in the order of a few microseconds, disturbing equipment in networks to which the source of disturbance is connected.

ELECTROSTATIC OVERVOLTAGES (ESD)

Electrically, a human being has a capacitance ranging from 100 to 300 picofarads, and can pick up a charge of as much as 15kV by walking on a carpet, then touch some conducting object and be discharged in a few nanoseconds, with a current of about ten Amperes. All integrated circuits (CMOS, etc.) are quite vulnerable to this kind of disturbance, which is generally eliminated by shielding and grounding.

NEMP PHENOMENA

(Nuclear ElectroMagnetic Pulses)

A high-altitude nuclear explosion, above the atmosphere, creates an intense electromagnetic field (up to 50 kV/m in 10ns), radiated to a ground area up to 1200 kilometers in radius.

In the ground, the field induces very large transient overvoltages in power and transmission lines, antennas, etc., destroying the terminal equipment (power circuit, computer terminals, telephone equipment, etc.).

The field rise may reach several kV/ns. While it is difficult to eliminate all overvoltages induced by an electromagnetic pulse, there are ways to reduce them and strengthen the systems to be protected. In spite of the amplitude of the phenomenon, protection can be provided by shielding and filtering/surge protection adapted to NEMP.

CONSEQUENCES OF SURGE VOLTAGES

The lightning incident is relatively common. Statistically, the share of damage caused by lightning on computer equipment is far from negligible.

The consequences of a disturbance are not always visible and immediate. The weakening of a component by an overvoltage can lead to a reduction in the lifetime of the equipment, or a 'deferred' failure. The user can therefore not make the link between the failure and the real cause. He will hasten to establish a bad diagnosis, therefore a bad treatment of the problem.

Overvoltages have many types of effects on electronic equipment; in order of decreasing importance:

Destruction

- Voltage breakdown of semiconductor junctions
- Destruction of bonding of components
- Destruction of tracks of PCBs or contacts
- Destruction of triacs/thyristors by dV/dt .

Interference with operation

- Random operation of latches, thyristors, and triacs
- Erasure of memory
- Program errors or crashes
- Data and transmission errors

Premature ageing

Components exposed to overvoltages have a shorter life.

The consequences of lightning strikes on installations are real since the standardization of electrical installations now makes the installation of SPDs compulsory in certain cases

SURGE PROTECTION DEVICES

The Surge Protection Devices (or SPD, generic name for any device to protect from voltage surges) is a recognized and effective solution for the overvoltage problem. For greatest effectiveness, however, it must be chosen according to the risk and installed in accordance with the applicable standards.

The SPDs are made of several types of components, like GDT (Gas Discharge Tube), GSG (Gas Spark Gap), MOV (Metal Oxide Varistor), SAD (Silicon Avalanche Diode), depending of the applications or the performances to reach.

As all types of networks could be stressed by surge voltages, SPDs are available for AC power, DC power, PV power, Telecom & Data-lines, LAN and Radiocommunication lines.

STANDARDS

Because of the diversity and importance of transients, standards organizations have created specifications for testing the effects of overvoltages on equipment.

The phenomena were first characterized and a series of standardized waves created (1.2/50 μ s voltage wave and 8/20 μ s or 10/350 μ s current waveforms), then a number of standards defining surge arrester performance were issued, among them :

Surge Protectors for AC installations :

- NF EN 61643-11 (France)
- DIN EN 61643-11 (Germany)
- EN 61643-11 (Europe)
- UL 1449 (USA)
- IEC 61643-11 (International)

Surge Protectors for PV installations :

- EN 61643-31 (Europe)
- IEC 61643-31 (International)

Surge Protectors for Telecom equipment :

- IEC 61643-21 (International)
- ITU-T recommendations K11, K12, K17, K20, K21, K36 (Int.)
- UL 497 A/B (USA)

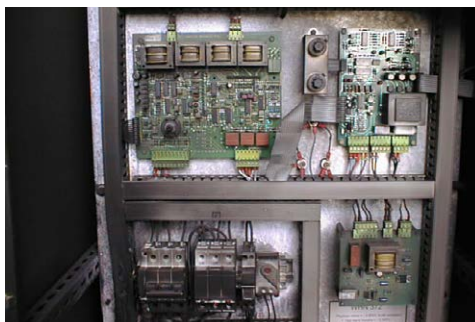



CITEL



DIN RAIL
AC POWER
SURGE PROTECTORS

DIN RAIL AC POWER SURGE PROTECTORS



CITEL AC power Surge Protective Devices (SPD) are designed to meet all your surge protection needs for any low voltage installation.

These DIN rail mounted surge protectors are easy to install in any standardized distribution panel or control cabinets. The SPDs are equipped with a thermal disconnection device and provide real-time fault indicators thus allowing complete operational safety.

DS and DAC surge protectors are available with several protection circuits to comply with even the most demanding installations and standards compliance requirements.

CITEL AC power surge protectors offer three levels of surge protection capacity that correspond to the different IEC or EN classes, i.e. Type 1, Type 2 or Type 3.

STANDARDS

To ensure efficient and reliable performances, all CITEL's AC power surge protectors comply with the leading standards. Relevant standards in the AC surge protection field could be split into 3 types of documents:

«Product» standards :

These documents address the type of tests the SPD manufacturer must apply on its devices :

- Europe : EN 61643-11
- Germany : DIN EN 61643-11
- International : IEC 61643-11
- USA : UL1449-4ed

«Installation» standards :

These documents give the main information about AC power surge protectors and their proper installation:

- International : IEC 61643-12 guide
- Europe : CLC/TS 61643-12
- USA : IEEE C62-41

«Selection» standards :

They define the basic rules to select the surge protector in accordance with the general electrical code :

- International : IEC 60364-4-433 and 5-534
- Europe : HD 60364 -4-443 and 5-534
- USA : NEC art. 280 & 285

OPERATING PRINCIPLE

CITEL surge protectors for AC network are based on zinc metal-oxide varistors (MOV), the best compromise between a fast response time (<25 ns) and a high discharge current capacity, which are the main parameters to provide efficient protection. Nevertheless the end of life of these varistors must be absolutely monitored thus requiring the systematic use of built-in thermal disconnection devices (see «Disconnection devices»).

DAC50 surge protector diagram

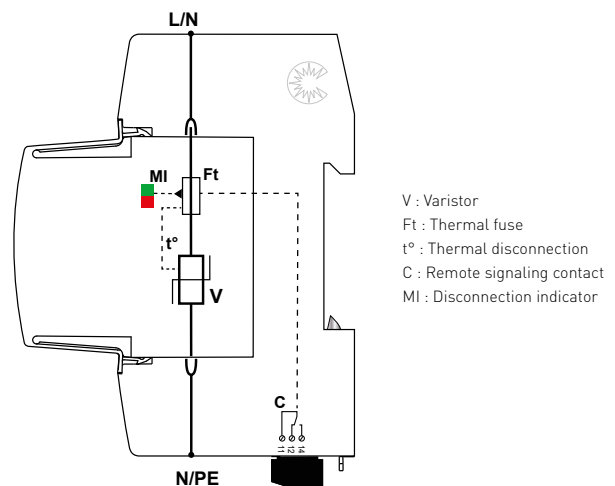

VG TECHNOLOGY BY CITEL



In order to improve the surge protection efficiency, CITEL has developed a patented technology which combines a high energy varistor (MOV) network and a specific gas tube (GSG). This specialized circuit incorporated in the «VG» Type "1+2+3" surge protectors (DAC1-13VG, DS250VG, DUT250VG) or Type "2+3" (DAC50VG) can achieve better performance of:

- Protection level,
- Life duration (due to suppression of leakage current),
- Non-disturbing operation (no follow current)
- TOV behavior.

For instance, these features allow it to reach, even with a single stage of surge protection, the same protection efficiency as a double stage association (Type 1, Type 2 and Type 3 SPDs) (see page 13).

SURGE PROTECTORS PARAMETERS

Surge protectors are defined by a series of electrical specifications which will help the user to select the right protection specific to their installation:

Operating voltage - U_c

The maximum continuous operating voltage (MCOV) U_c is the maximum AC voltage which may be applied continuously to the SPD, with safety margin.

Temporary overvoltage - U_T

The temporary overvoltage U_T (TOV) is the maximum AC voltage the surge protector can withstand during defined durations (5 seconds and 120 mn), without failure or with controlled disconnection. This parameter U_T is greater to U_c .

An additional test is required for TT AC system, to simulate a temporary «high voltage» overvoltages (TOV) between Neutral and PE (application of 1200 Vac, 300 A for 200 ms): the compliance with this test requires the use of the CT2 diagram (specific gas tube between N and PE).

Discharge current - I_n and I_{max}

The maximum discharge current (I_{max}), applicable to Type 2 SPD, is the maximum impulse current 8/20 μ s a surge protector can withstand without destruction.

The nominal discharge current (I_n) is the level of 8/20 μ s impulse current a surge protector Type 1 or Type 2 can withstand repeatedly (15 surges) without destruction.

Impulse current - I_{imp}

The impulse current (I_{imp}), used in Class I test applicable to Type 1 SPDs, is the maximum impulse 10/350 μ s current a surge protector can withstand without destruction. This test simulates the effect, on AC power surge protectors, of a direct lightning strike on an installation.

Total discharge current - I_{total}

Total discharge current flowing in the PE or PEN conductor of a multipolar surge protector.

Specific energy - W/R

Energy discharged during the flow of the surge current I_{imp} , during the Class I test. Expressed in kJ/ohm.

Open circuit voltage - U_{oc}

This parameter is used only for Class III test, applicable to Type 3 SPD and consists of the injection of a combination wave (1.2/50 μ s in open circuit - 8/20 μ s in short circuit).

Protection level - U_p

Maximum residual voltage of the surge protector during an 8/20 μ s current injection with the declared rating of the I_n or I_{imp} currents (or during a 1,2/50 μ s @ 6kV impulse voltage test, if required).

Residual voltage

Residual voltage of the surge protector during an 8/20 μ s current waveform injection at a determined rating (i.e 5 kA).

Short circuit current capability - I_{sc}

The surge protection and its associated disconnecter (Fuse) are tested to disconnect safely on a maximal short circuit current value (i.e.: 50 kA) : This I_{sc} value needs to be higher than the short circuit current value of the network at the installation point.

Follow on current extinction capability - I_{fi}

This criteria is only devoted to surge protection using the "air gap" technology : once they have fired, these surge protectors conduct part of the network current (follow on current) and need to interrupt it. This behavior does not concern AC power surge protector using Metal Oxide Varistor technology.

DIN RAIL AC POWER SURGE PROTECTORS

TYPE OF SURGE PROTECTORS

The AC power surge protectors are split into 3 categories by IEC 61643-11 and EN 61643-11 standards, following 3 classes of tests. These different tests depend on the location of the surge protector in the AC network and on the external conditions.

Type 1 surge protectors

Type 1 surge protectors are designed to be installed when a direct lightning strike risk is high, especially when the building is equipped with external lightning protection system (LPS or lightning rod). In this situation, EN 61643-11 and IEC 61643-11 standards require the Class I test to be applied to surge protectors : this test is characterized by the injection of 10/350 μ s impulse current in order to simulate the direct lightning strike consequence. Therefore these Type 1 surge protectors must be especially powerful to conduct this high energy impulse current.

Type 2 surge protectors

Type 2 surge protectors are designed to be installed at the entrance of the installation, in the main switchboard, or close to sensitive equipment, on installations without LPS (lightning rods). These protectors are tested following the Class II test from IEC61643-11 or EN61643-11 standards and based on 8/20 μ s impulse current injection.

Type 3 surge protectors

In case of very sensitive or remote equipment, secondary stage of surge protectors is required : these low energy SPDs could be Type 2 or Type 3 (see «Coordination of surge protector» page 20). Type 3 SPDs are tested with a combination waveform (1,2/50 μ s - 8/20 μ s) following Class III test.

Surge protector combination

Surge Protectors incorporating VG technology provide protection equivalent to a coordination of a Type 1 + Type 2 + Type 3 surge protectors. Advantages: reduces the cost and time of installation. Simplifies selection (no calculation of coordination) (see page 15-16).

Different SPD types following IEC and EN standards

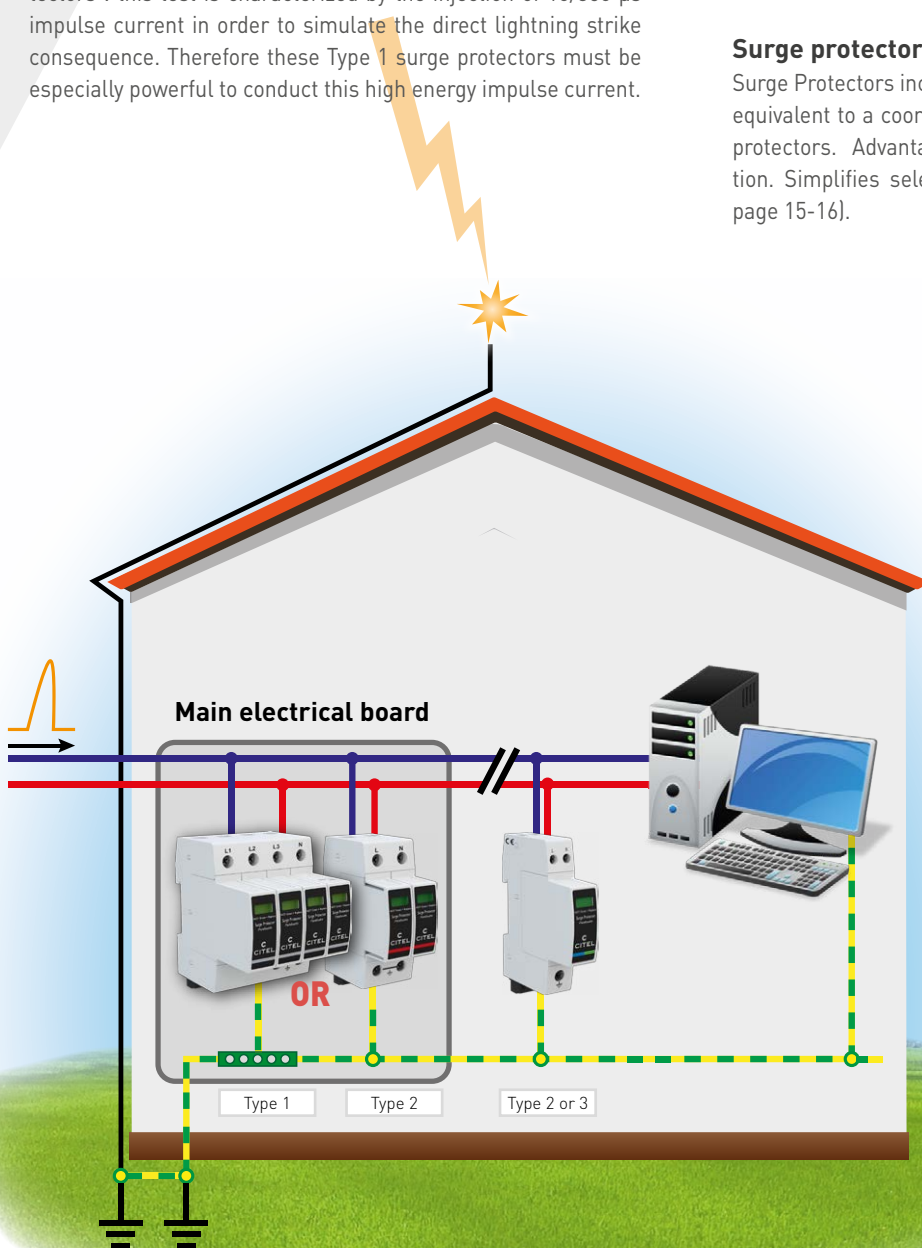

AC power Surge Protector DAC50

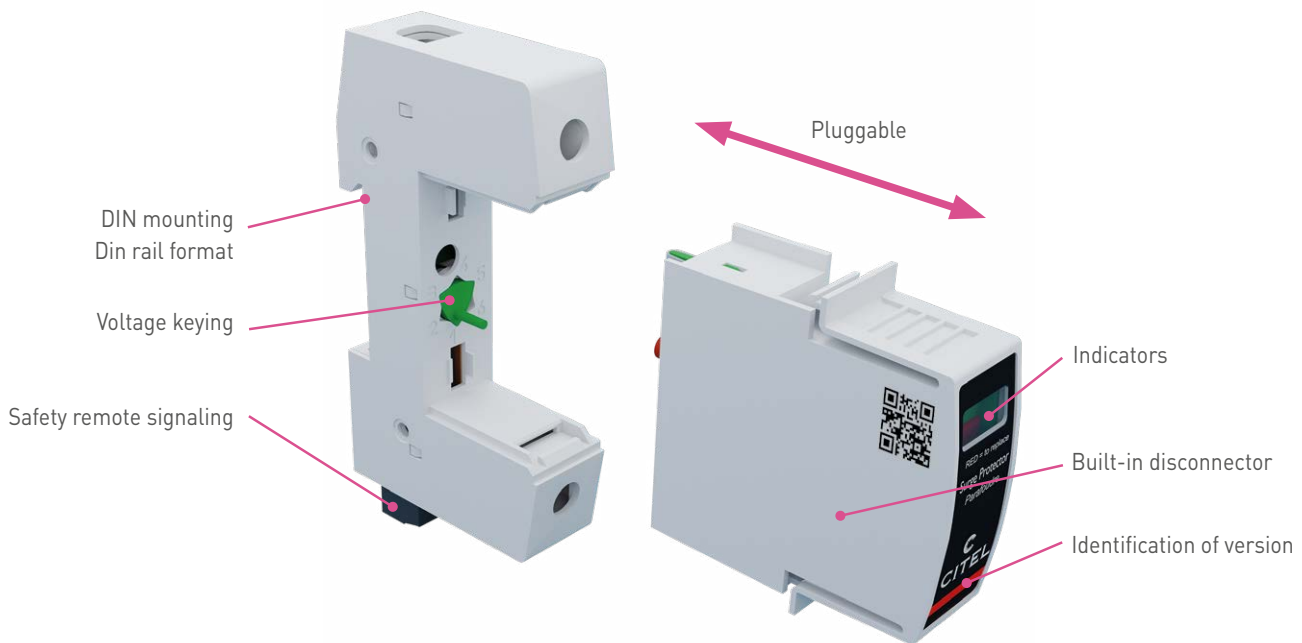

DISCONNECTION DEVICES

In compliance with the standards, the AC power surge protectors are equipped with internal disconnection devices and associated to external devices, in order to provide total safety in case of failure.

2 types of devices are necessary :

- **Internal thermal security** which will disconnect the surge protector from the AC network in case of thermal runaway. In such a case, the user will be warned about the trouble by an indicator in front of the protector and will carry out the replacement of the defective SPD.

- **External electrical disconnection** (fuses or breaker) to disconnect the surge protector from the AC network in case of internal short circuit, e.g. due to an excessive impulse current. The rating of the external fuses are in relation with the discharge capability of the SPD and the prospective short-circuit current of the installation and must be tested together with the surge protector in order to ensure compliance of the short-circuit current withstand test (I_{sc} parameter). To ease the selection of these components, the rating and type of fuses are mentioned in the datasheet and in the installation instructions of each SPD (see «associated fuses» page 17).

Some specific versions, as DACF25/DACF15 series, are equipped with internal protection against short circuit currents and, by this way, can be installed without the need of external devices.

MAINTENANCE

DAC surge protectors are designed for repetitive operation and do not require specific maintenance. Nevertheless, in case of an extreme event, a controlled end of life could occur (see above) and a maintenance operation must be performed.

Pluggable design

The design of most of the CITEL AC power surge protectors is based on the use of a pluggable module that plugs into a matching receptacle. This makes replacement, and checking very easy without impairing the protection function. On multipolar surge protectors, the possibility of replacing a single pole makes rehabilitating a surge protector less expensive. The plug-in module is identified with a color label in relation with the type (Black/Grey = Type 1 ; Red = Type 2 ; Blue = Type 2 low power or Type 3) and are keyed for operating voltage, in order to avoid misapplications.

Signaling

DAC surge protectors are equipped with a mechanical failure indicator linked to the internal thermal disconnector: in case of safety disconnection, the indicator will switch on and the SPD must be replaced.

Remote Signaling

DAC surge protectors are available in «remote signaling» versions. This feature, which allows remote checking of the status of the surge protector, is especially important when the products are hard to reach or unsupervised. The system consists of an auxiliary changeover contact that is activated if the surge protector module changes status. This lets the user monitors :

- the good operation of the SPD
- the presence of the plug-in modules (if any)
- the end of life (disconnection) of the surge protector.

The remote signaling version allows the choice of signaling system appropriate to the installation (light, buzzer, automation, modem transmission...).

VG TECHNOLOGY FOR AC AND PHOTOVOLTAIC SURGE PROTECTORS



Several technologies exist on the market for surge protection of power network:

- **Metal Oxide Varistor (MOV)**
- **Air Gap + Trigger**
- **CITEL VG Technology → MOV + GSG**
(gas-filled Spark Gap)

VG TECHNOLOGY

This technology is the exclusive and patented technology of CITEL based on the use of specific types of Gas tubes: GSG. These components, the result of over 80 years of experience in the gas discharge tube field, have a behavior adapted to the power network and provide robustness and working stability: their association with varistors combines the advantages of both technologies. CITEL originally developed the "VG" technology for low voltage

Type 1 surge protectors and has then extended it to Type 2 surge protectors and to Photovoltaic applications.

CITEL RANGE USING THE "VG" TECHNOLOGY:

- DAC50VG : Type 2 AC power SPD, I_{max} = 50 kA
- DAC1-13VG : Type 1 AC power SPD, I_{imp} = 12.5 kA
- DS250VG : Type 1 AC power SPD, I_{imp} = 25 kA.
- DUT250VG : 3-phase Type 1 AC power SPD, I_{imp} = 25 kA.
- DS60VGPV : Type 1 PV power SPD, I_{imp} = 12.5 kA
- DS50VGPV : Type 2 PV power SPD, I_{max} = 40 kA

ADVANTAGES OF VG TECHNOLOGY

versus other technologies (specifically the triggered spark gap)



1. Gas-filled-Spark Gap (GSG)

CITEL VG surge protectors are using specific gas discharge tubes: GSG. These essential components are the result of over 80 years of experience in the gas discharge tube field, are meant for power network and ensure a perfect electrical stability.



→ Increase reliability

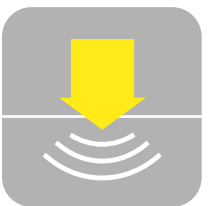

2. Very low clamping level and high surge current capability

GSG are able to conduct very high surge currents (I_{imp}, I_{max}) with a very low residual voltage (U_p). Such characteristics could only previously be reached with the combination of a Type 1 and a Type 2 surge protector.



- Equivalent to Type « 1+2+3 » or « 2+3 » solutions
- Maximum efficiency
- Compact design



3. Increased TOV withstand

VG surge protectors can handle very high TOV levels (Temporary over Voltage) up to 450 Vac without any failure or degradation to the level of protection.



→ Increased reliability for areas with unstable power networks.

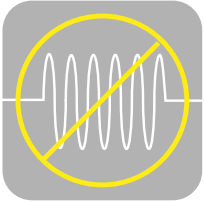

4. No follow current

Unlike to "Air Gap" technologies, "VG" Technology does not create any follow on current.

VG solution increases service continuity by no tripping of the upstream overcurrent protection device during surge events.



→ Improvement of the network quality (no power line disturbances)

→ Easy selection



5. Robustness and reliability

All the components of the VG surge protector are designed to handle high impulse discharge currents without any assistance from auxiliary systems. On the contrary, the "Triggered Air Gap" technology includes a control circuit, using very sensitive components, which could be stressed by a part of the surge current and will eventually fail.



→ Increase reliability

→ Better life expectancy

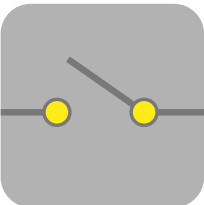

6. Safe disconnection and Device status signalization

VG surge protectors use a safe disconnection system and provide real-time status indication of internal components. For a "Triggered Air Gap" technology, the disconnection and signalization only can provide the status of the control circuit and not the main protection circuit.



→ Safe and efficient maintenance



7. No ageing

During normal operation, in addition to transient events, varistors are always conducting a small amount of current. This leakage current can be stressful to the varistor over time, especially in DC power systems, and cause the varistor to age prematurely.



→ Maximum life expectancy

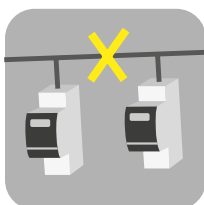

8. Easier surge protection coordination

In the case of coordinated SPD installations, the surge protector downstream a VG surge protector does not need any special consideration, such as a sufficient distance between locations, in order to ensure a working coordination between multiple SPDs. Note: due to its optimized protection level, the VG surge protector can be used without any additional surge protector



→ Easier to use

CONCLUSION :

CITEL Surge Protectors based on VG technology offer the best level of efficiency and reliability, conditions essential for achieving the maximum performance of your surge protection system.

DIN RAIL AC POWER SURGE PROTECTORS

SURGE PROTECTION INSTALLATION

Location

CITEL DAC or DS surge protectors are installed as follows, according to their types :

- **Type 1 or «Heavy duty»** : at the origin of the installation, in a separate box or on the main electrical panel, for efficient discharge of partial lightning currents.
- **Type 2 or «Primary»** : at the origin of the installation, on the main electrical panel, in order to eliminate impulses currents as fast as possible and thereby avoid coupling.
- **Type 2 (or Type 3) or «Secondary»** : on the secondary panel, near the sensitive equipment, to limit ringing voltages and improve the level of protection.

Wiring

Since lightning surges are essentially common-mode phenomena, AC power surge protectors are connected mainly in common mode (between the active conductors and PE).

Some recommendations call for additional differential-mode protection (between phase and neutral). For these applications, CITEL offers specific versions, using L/N protection branches (differential mode) and a specific gas tube branch for the Neutral to PE (common mode) protection: this type of installation is called a «CT2 connection» in IEC 60364 standard, is used in surge protectors such as DAC50-31-275.

ASSOCIATED FUSES

To comply with standards and safety, the AC surge protectors must be protected against a possible end of life in short-circuit: the user must install on each SPD branch, a protection against short-circuit current (specific disconnectors, standard fuses or breaker).

The type and the rating of these devices are given by the SPD manufacturer in the product datasheet or installation instructions. The choice of this rating depends of 2 criteria:

- Withstand of the short-circuit current test in the IEC 61643-11 standard: the fuse must cut safely the short-circuit current before a harsh destruction of the SPD.
- Withstand of the discharge currents (In or Iimp): the fuse must be able to conduct the discharge current of the SPD without blowing.

SPECIFIC DISCONNECTORS

CITEL has designed a range of specific external disconnectors for SPD (SFD1 range) to replace the regular fuses :

- Optimized and tested in impulse current
- Compacts
- Equipped with strickers to indicate their status and to monitor the remote signal feature of their holders (see page 63).

INTEGRATED DISCONNECTORS

Some specific versions, as DACF25/DACF15 series, are equipped with internal disconnector against short circuit currents, in addition of the internal thermal disconnectors, and, by this way, can be installed without the need of external devices. These SPDs are classified as "SPDI".

Common mode protection :

CT1 Connection

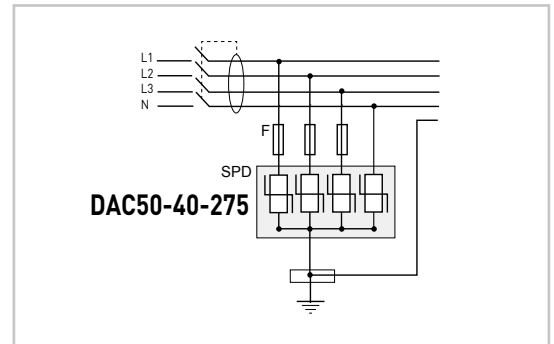

Common and differential mode protection :

CT2 Connection

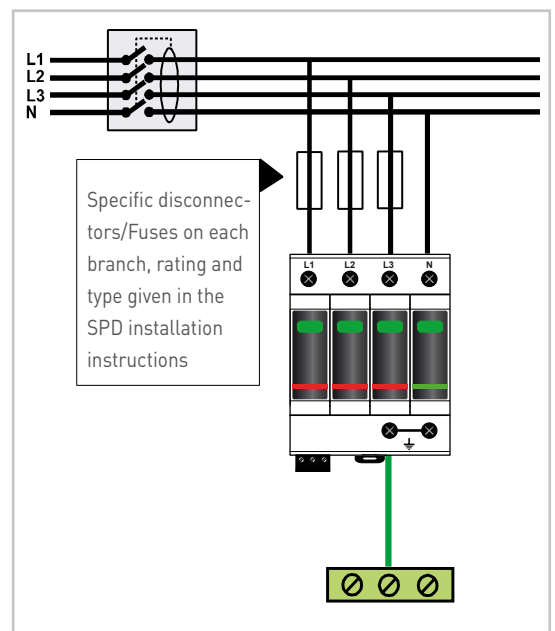
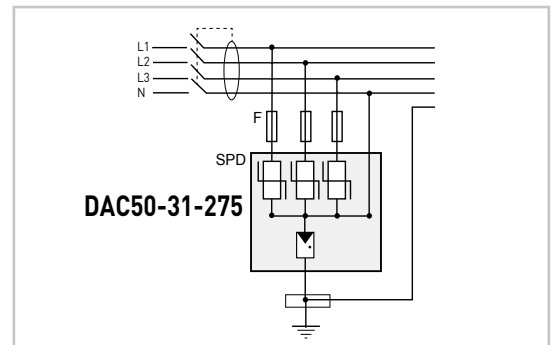

Installation

DAC surge protectors are connected in parallel on the AC network and must be equipped with external fuses for short-circuit current protection (see paragraph «Associated fuses»).

- The total length of parallel connection wires to AC network must be lower than 0.5 m in order not to increase the protection level (Up) provided by the SPD.
- Wiring is made by screw connections. On some models, a distribution bus can be used.
- The protection wire coming from the SPD must be connected to the bonding bar of the electrical panel. Paralleling the protection wire with phases conductors must be avoided.

- The cross sectional wire must be 6 mm² minimum for Type 2 SPD and 16 mm² for Type 1.
- Local earthing resistance must be in compliance with the electrical rules.

Further information can be found in IEC 61643-12 standard (selection and application principles for low voltage SPD).

Installation example

Type 2 surge protector DAC50S-31-275

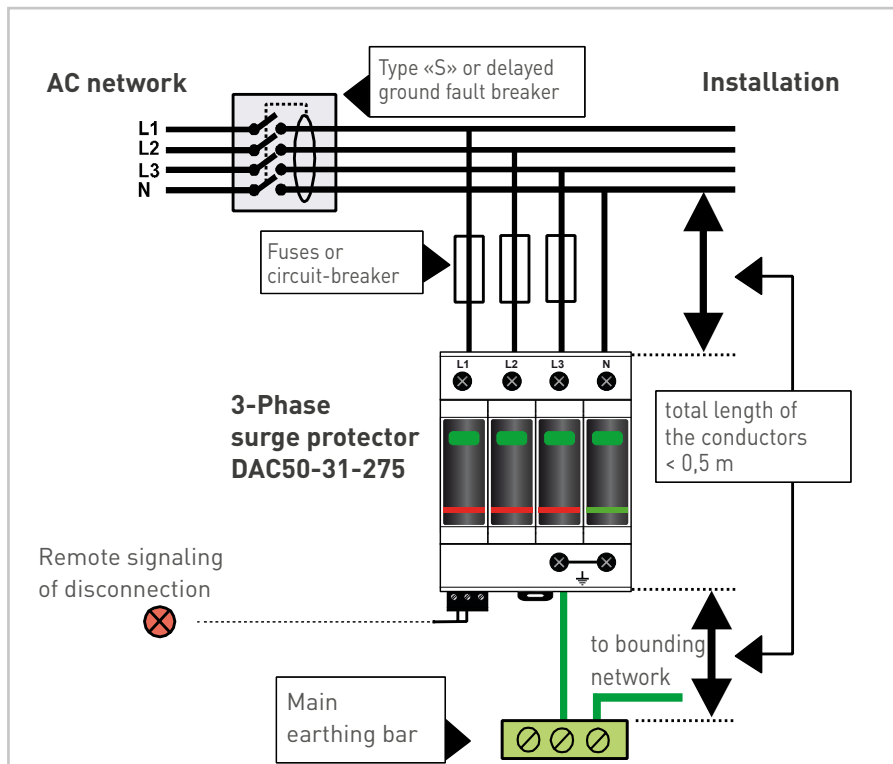

DIN RAIL AC POWER SURGE PROTECTORS

CHOOSING SURGE PROTECTORS

CITEL's line of AC power surge protectors is designed to cover all possible configurations in AC low voltage installations.

They are available in many versions, which differ in :

- Type (1, 2 or 3) or Test Class (I, II or III)
- Operating voltage (Uc)
- AC network configuration (Single/3-Phase)
- Discharge currents (Iimp, Imax, In)
- Protection level (Up)
- Protection technology (varistors, VG technology, filter)
- Features (differential mode, plug-in, remote signaling, compact, integrated fuse..).

The surge protection selection must be done following the local electrical code requirements (e.g. : minimum rating for In) and specific conditions (e.g. : high lightning density).

Choosing the Type of surge protectors

The type of surge protector is based on its location and the constraints of the installation to be protected.

Configuration	SPD	Location	CITEL
Installation equipped with LPS or could be hit by lightning	Type 1+2 Type 1+2+3	Origin of the installation origin (Panel or main switchboard)	DAC1-13 DAC1-13VG DS250VG DUT250VG DS250E DS500E
Installation without LPS	Type 2 Type 2+3	Main switchboard	DAC80, DAC50 DAC50VG DAC40C DACF25
Secondary protection (downstream primary SPD)	Type 2 (or Type 3)	Close to protected equipment	DAC15C DACF15 DACN10

Choosing the operating voltages Uc and Ur

The SPD Uc voltage (maximum continuous operating voltage) depends on:

- Nominal voltage of the AC network (Uo)
- Type of AC system (TN, TT, IT).

The level of withstand to temporary overvoltages (UT) is related to the Uc voltage. In addition, withstanding the "high voltage" TOV (1200 Vac, 300 A, 200 ms) between Neutral and PE is needed in TT AC system, which requires the CT2 diagram.

Operating voltage Uc (Line/Earth)

AC Network	230/400V		
AC system	TT	TN	IT
Uc Voltage mini	255 V	255 V	440 V
UT Voltage	335/440V	335/440V	-
TOV N/PE	1200 V	-	-
Example of CITEL products	DAC50-11-275	DAC50-20-275 DAC50-11-275	DAC50-30-440

Choosing the AC network configuration

DAC and DS surge protectors are available for single, 3-Phase and 3-Phase + neutral AC networks.

Choosing Iimp

The impulse current Iimp is defined for Type 1 SPD. The minimum rating for Iimp is 12.5 kA by pole, following IEC 60364-5-534. This level is adapted to the real phenomenon. This value can, however, be increased according to the risk (calculation according to IEC 62305-1)

CITEL proposes, in its Type 1 SPD range, 3 levels of Iimp current by pole: 12.5, 25 and 50 kA.

Configuration	Iimp/pole	CITEL
Maximum risk	50 kA	DS500E
Very high lightning density	25 kA	DS250VG, DS250E DUT250VG
High, medium or low lightning density	12.5 kA	DAC1-13, DAC1-13VG

Choosing In

The minimum rating of In for a SPD connected at the installation entrance is 5 kA (8/20 μ s waveform), required by standard.

Nevertheless higher ratings are advised in case of high lightning density. Moreover higher values of In current will increase the SPD lifetime.

Imax (maximum discharge current) rating is linked to In.

Conditions	In	CITEL
Very high lightning density	> 20 kA	DAC80
High or medium lightning density	10-20 kA	DAC50 DAC50VG DAC40C, DACF25
Low lightning density or secondary SPD	\leq 5 kA	DAC15C, DACF15, DACN10

Choosing the protection level Up

The user must select a surge protector with a protection level Up adapted to the withstand level of terminal equipment. In every case, the lower the protection level Up, the better the protection. IEC 60364 standard calls for the minimum protection level of 2.5 kV for a SPD connected at the entrance of a 230/400 V network: this level is in compliance with the withstand of robust devices (electromechanical type).

Electronic-based terminals have lower impulse withstand and require a better protection: so, surge protectors with 1.5 kV protection are necessary to provide efficient protection.

Conditions	Recommended Up	
	230/400 V AC network	120/208 V AC network
SPD at the installation entrance	2.5 kV max.	1.5 kV max.
Electromechanical protected equipment	2.5 kV	1.5 kV
Electronic-based protected equipment	1.5 kV	0.8 kV

Choosing the SPD technology

A relevant choice of the SPD technology, as well as the use of coordination diagram can help to improve the protection level.

DAC and DS surge protectors are based on Varistor (MOV) technology.

Some versions use different electrical diagrams in order to improve some of their characteristics :

➔ «VG» technology :

This GSG-MOV hybrid association, used in SPD: DAC1-13VG, DS250VG, DUT250VG, DAC50VG, improves the reliability and the efficiency (see page 15-16)..

➔ Association with RFI filter :

The Surge protection panel M series and secondary SPDs DS40HF and DS-HF combine surge protection stage and/or filter stage in order to improve the protection level.

Coordination of Surge Protectors

In order to provide maximum protection efficiency, it is necessary to create a «coordination» diagram, that means installation of a «primary» SPD at the network entrance and a «secondary» close to sensitive equipment.

This association is required in the 2 following cases :

- **Long length** (greater than 10 m) of wire between equipment to be protected and primary SPD : Coordinated SPDs will reduce the ringing voltages created during the surge transmission.
- **High sensitivity equipment** : Coordinated SPDs will improve of protection level.

Efficient SPD coordination is performed by including between primary and secondary SPDs :

- a minimum length of wire (> 10 m)
- or
- a coordination inductor (DSH range).

Coordination with VG Surge Protector

With VG technology, there is no consideration of the cable length or to use inductance (see page 21) : a secondary SPD can be connect directly downstream the primary one.

Coordination by conductor

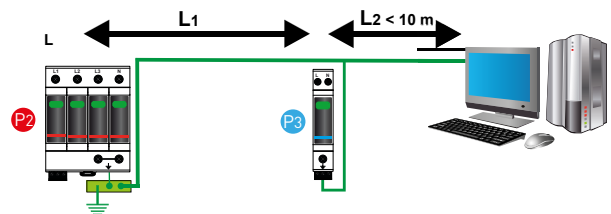

Coordination by inductor

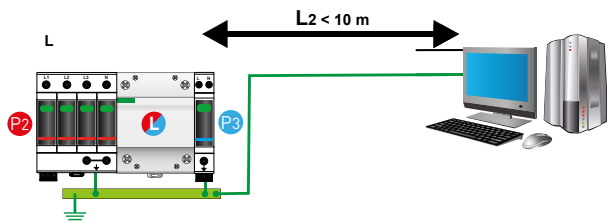

- P2 : Primary surge protector (ex. DAC50)
- P3 : Secondary surge protector (ex. DAC15C)
- L : Coordination inductors (ex. DSH35)
- L1 : Length of conductor between surge protector
- L2 : Length of conductor between surge protector and installation



DAC AND DS SURGE PROTECTORS WIRING

COORDINATION OF SURGE PROTECTORS

In order to provide maximum protection efficiency, it is necessary to create a «coordination» diagram: that means installation of a «primary» SPD at the network entrance and a «secondary» close to sensitive equipment.

Efficient SPD coordination is performed by including, between primary and secondary SPDs:

- a minimum length of wire (> 10 m).

or

- coordination inductors (DSH range: see below).

Further information is available in installation instruction sheet.

Example of coordination on 3-Phase network

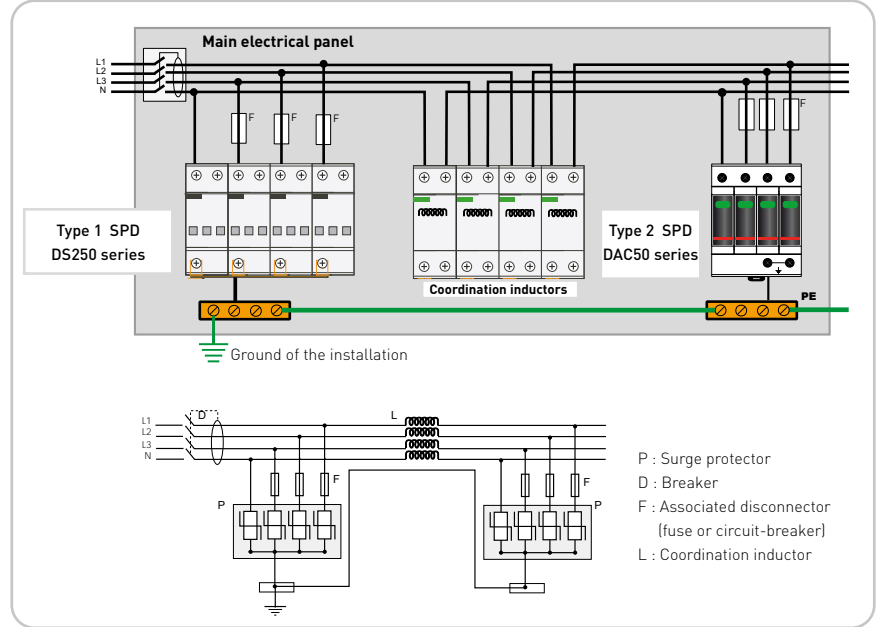

DIRECT COORDINATION WITH VG SURGE PROTECTOR

An additional benefit of the VG technology is to ensure effective coordination with secondary surge arrester without special precautions (no decoupling length required). It is therefore possible to directly connect the output of the surge arrester head VG secondary.

Note: However, because of the very high lightning discharge capacity and low residual clamping of the VG SPD, the addition of a secondary surge protector is not necessary.



Example of coordination on 3-Phase network

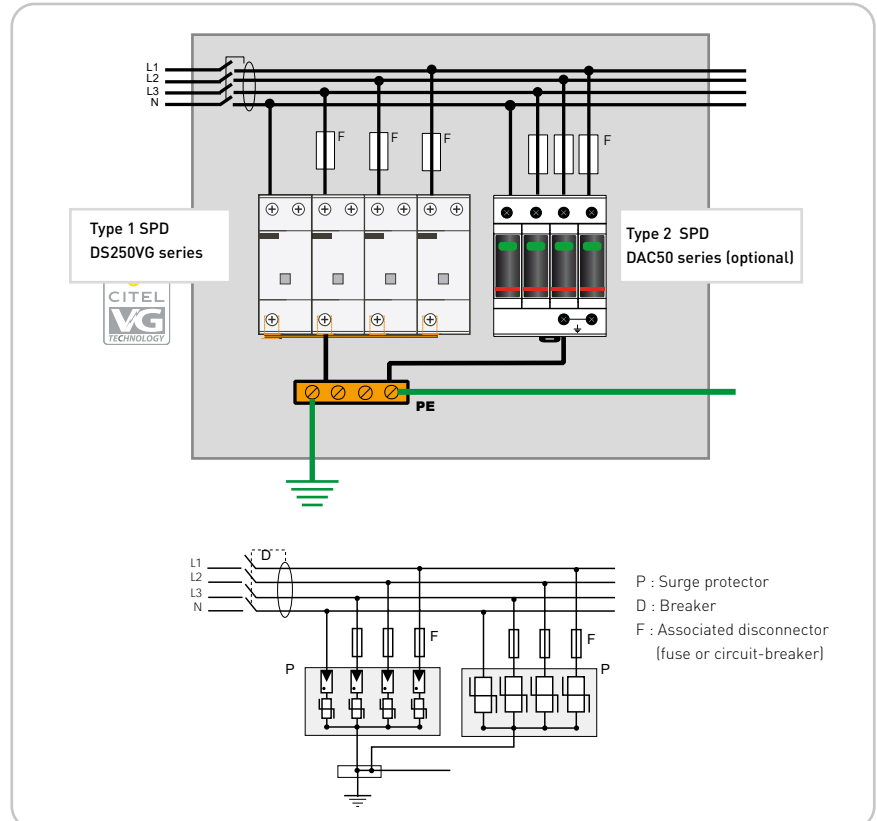

COMMON MODE PROTECTION (CT1 CONNECTION)

Common mode (L/PE or N/PE) protection provided by DAC/DS surge protectors in relation with the different types of AC network. Called CT1 connection type in IEC 60364 std.

1 Type 1 Surge Protector Single-phase network

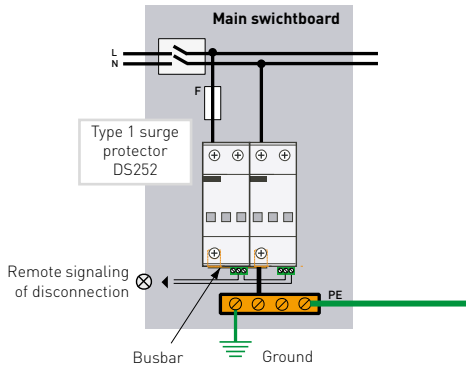

4 Type 2 Surge Protector Single-phase network

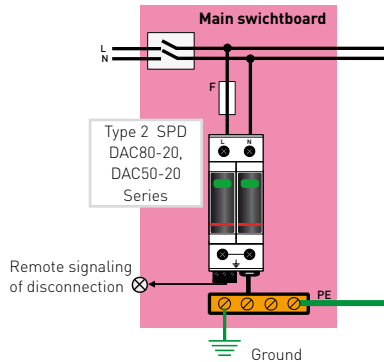

Diagram

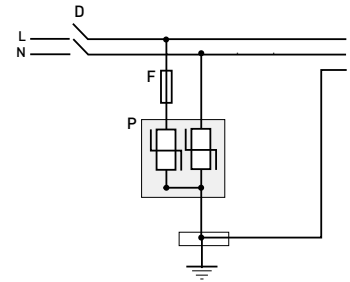

2 Type 1 Surge Protector 3-Phase network

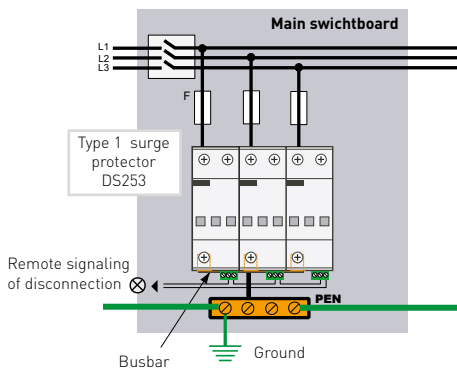

5 Type 2 Surge Protector 3-Phase network

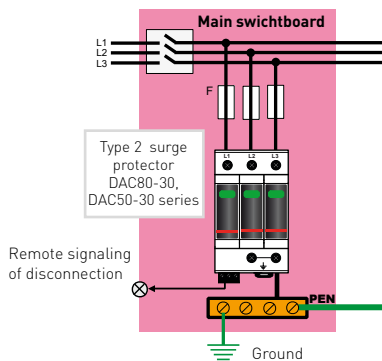

Diagram

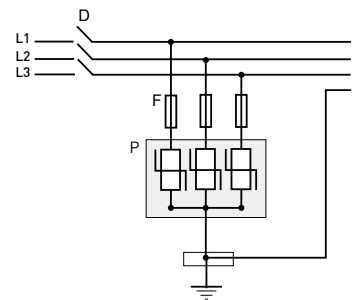

3 Type 1 Surge Protector 3-Phase network + neutral

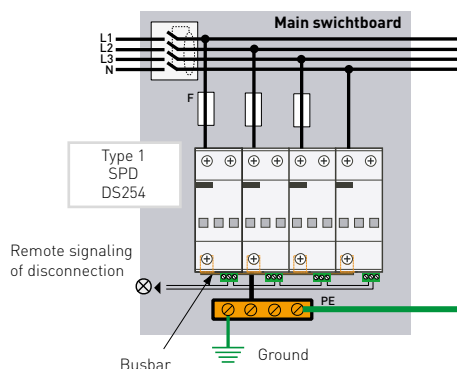

6 Type 2 Surge Protector 3-Phase network + neutral

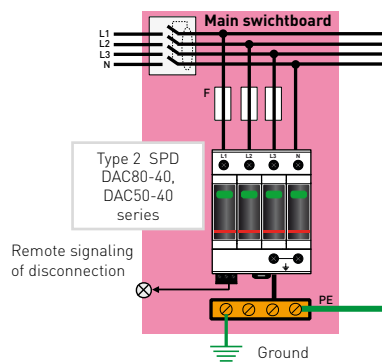

Diagram

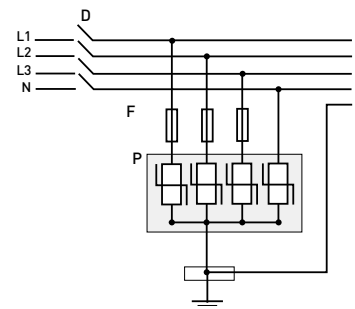

P : Surge protector
 D : Circuit breaker
 F : Associated disconnector (fuse or circuit-breaker)

DAC AND DS SURGE PROTECTORS WIRING

COMMON AND DIFFERENTIAL MODE PROTECTION (CT2 CONNECTION)

Common mode (N/PE) and differential mode (L/N) protection provided by DAC/DS surge protectors in relation to the different types of AC network. These configurations CT2 (following IEC 60364) are also called "1+1" and "3+1" mounting.

7 Type 1 Surge Protector Single-phase network

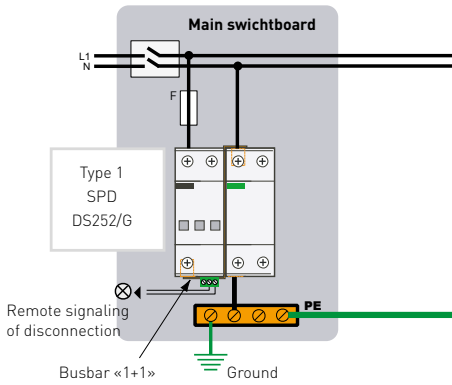

9 Type 2 Surge Protector Single-phase network

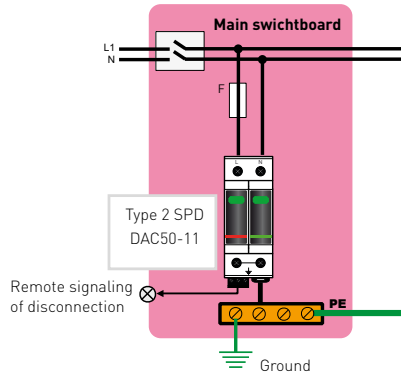

Diagram

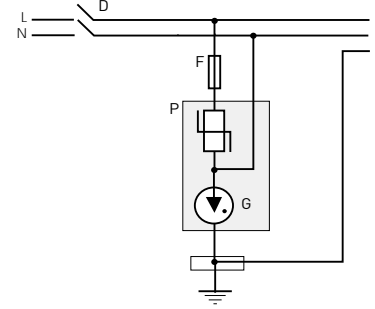

8 Type 1 Surge Protector 3-Phase network + neutral

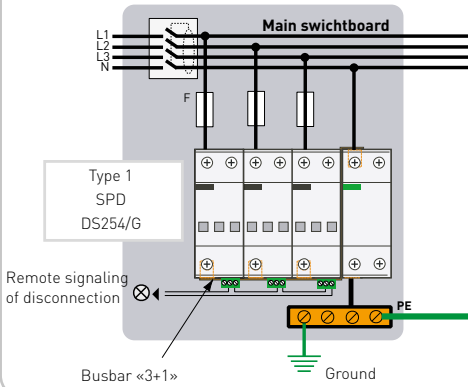

10 Type 2 Surge Protector 3-Phase network + neutral

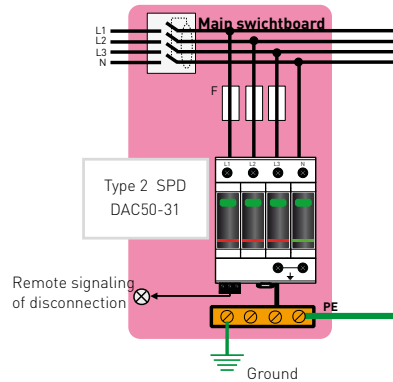

Diagram

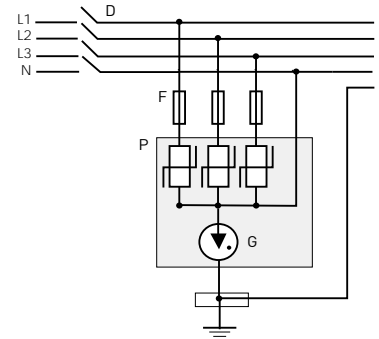

11 Type 1 Surge Protector 3-Phase network + neutral

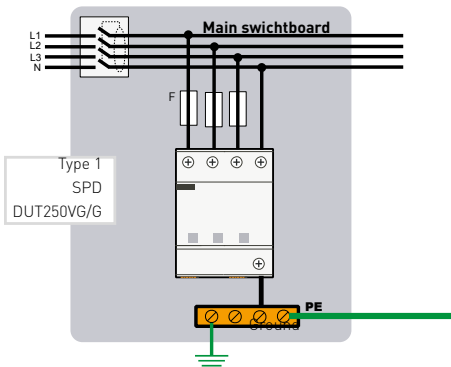

Diagram

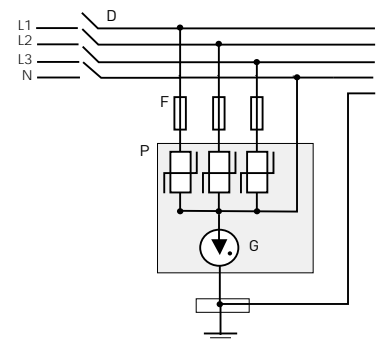

P : Surge Protector
 G : Surge protector with GDT
 D : Circuit breaker
 F : Associated disconnector (fuse or circuit-breaker)

MULTIPOLE TYPE 2 SURGE PROTECTORS WIRING

Wiring instructions for DAC/DS multipolar and monobloc Type 2 surge protectors according to different types of networks.

12 Type 2 Surge protector Single-phase network

Diagram

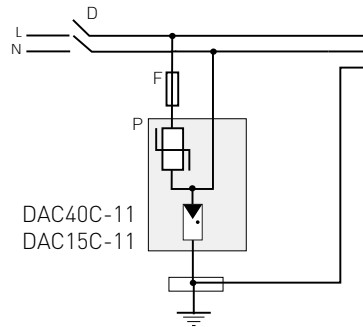
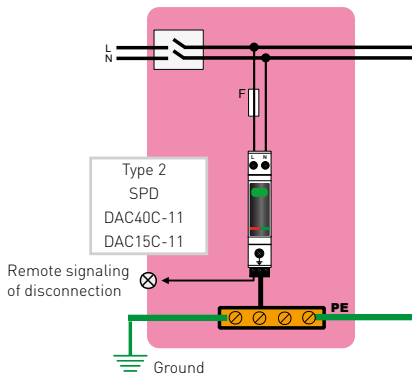

13 Type 2 Surge protector 3-Phase network + neutral

Diagram

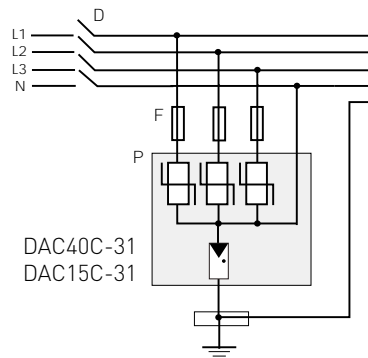
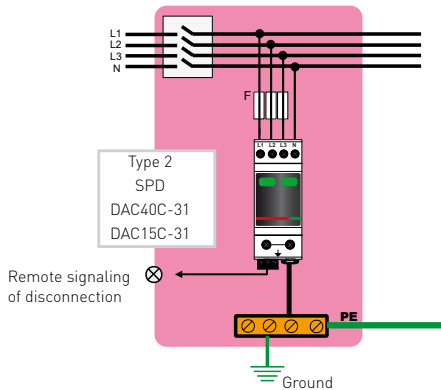

14 Type 2 surge protector + Filter Single phase network

Diagram

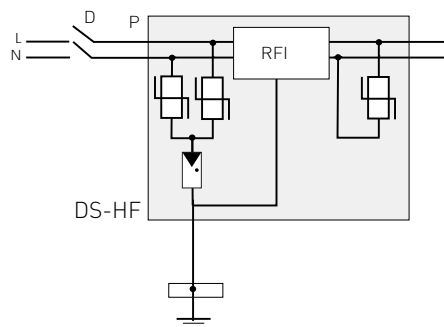
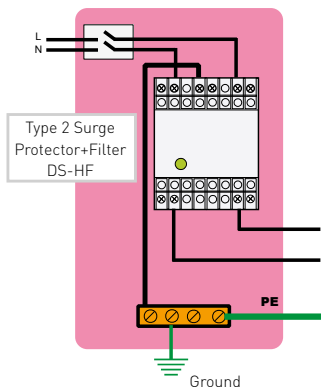

P : Surge protector
RFI : RFI filter
D : Breaker
F : Associated disconnecter
(fuse or circuit-breaker)

INTERNATIONAL STANDARDS FOR AC SURGE PROTECTORS

The performance, selection and application of AC surge protectors are defined by standards, to ensure an efficient and secure use.

National standards are based on IEC international standards. In the field of AC surge protection, several documents must be taken into consideration.

STANDARDS IN AC SURGE PROTECTION

Related standards for test performance, selection and application of low voltage SPDs are :

General rules : IEC 60364 standard

- **Section 4-443** : «Protection against overvoltages of atmospheric origin or due to switching» :

This section of IEC 60364 is intended to describe the means by which transient overvoltages can be limited and describes the configurations where the surge protection is necessary.

- **Section 5-534** : «Devices for protection against overvoltages» : This section gives the basic requirements for the selection and implementation of the SPDs for electrical installation of buildings to obtain a limitation of transient overvoltages.

Product test standard : IEC 61643-11 :

This document addresses performance tests for AC surge protective devices (SPDs) following different classes (Class I , II or III tests). It is mainly dedicated to surge protector manufacturers.

Selection and application guide : IEC 61643-12 :

This guide addresses in details the selection and application principles of SPDs in practical situations.

RECOMMENDATIONS FOR SPD INSTALLATION

Section 4-443 of IEC 60364 recommends SPD application depending of the type of installation :

Protection against transient overvoltage shall be provided where the consequence caused by overvoltage affects:

- a) human life, e.g. safety services, medical care facilities;
- b) public services and cultural heritage, e.g. loss of public services, IT centres, museums;
- c) commercial or industrial activity, e.g. hotels, banks, industries, commercial markets, farms.

For all other cases (dwellings, small apartment buildings), a risk assessment (based on Lightning density, Length of external low voltage lines and Environment factor) shall be performed in order to determine if protection against transient overvoltage is required.

SELECTION OF THE SPD

Section 5-534, among other, gives the minimum performance required for SPD installed at the entrance of installation :

1 - The installation equipped with lightning rod (LPS):

➡ Recommendation : Type 1 SPD, with Lightning impulse current Iimp of 12.5 kA minimum, connected at the origin of the installation.

2 - The installation is connected to an AC network, without LPS :

➡ Recommendation : Type 2 SPD, with nominal discharge current In ≥ 5 kA, connected at the origin of the installation.

Application of the AC surge protectors following IEC 60364-4-443

Consequences caused by overvoltage, or Type of installations	SPD application
Loss of human life, e.g. safety services, medical care facilities;	Mandatory
Loss of public services and cultural heritage, e.g. loss of public services, IT centres, museums;	Mandatory
Loss of commercial or industrial activity, e.g. hotels, banks, industries, commercial markets, farms.	Mandatory
Dwellings or apartment buildings	Risk analysis required

CONCLUSION

Following international rules, AC surge protectors are required for most of the installations.

Risk assessment methods are also available to determine more accurately the need of surge protection.

NORTH-AMERICAN REGULATION ON LOW VOLTAGE SURGE PROTECTION DEVICES

STANDARD STATUS

In North America, the IEC international standard does not apply. Other national standards and guidelines exist, such as UL, NEC and ANSI/IEEE, which are used to determine your risk to transients in low voltage power networks as well as the use of appropriate protector for each application.

NEC (National Electrical Code):

The article 285 of NEC defines the use of standalone surge protectors and imposes their compliance with the product standard UL1449 Ed. 4.

The article 285 defines the selection and installation conditions of SPDs.

Product Standard: UL1449, 4th Ed.:

This document, devoted to surge protection manufacturers, defines the parameters as well as the test procedure to qualify an SPD: it is important to note that the UL Type designations of surge protective devices, while similar, is not exactly the same as SPD types in IEC61643-11.

SPD type according to UL 1449 4th Ed.:

Type 1 - Permanently connected surge protection devices to be installed both, on the supply side and the load side of the equipment main overcurrent protective device. The surge protection devices are supposed to be self-protected against short circuits and do not require external protection.

Type 2 - Permanently connected surge protection devices to be installed on the load side of the main equipment overcurrent protective device. This surge protection device requires an external short circuit protection device.

Type 3 - Surge protection devices installed at a conductor length of 10 meters or greater from the electrical panel. For example, the mobile surge protectors (that can be plugged into the outlet such as a multiple power outlet etc.). They can also be directly installed on the equipment to be protected.

Type 4 « Component Assemblies » - Component Assemblies consisting of one or more Type 5 components and a disconnect complying with the limited end-of-life short circuit current tests (0.5A, 2.5A, 5A and 10A).

Type 1, 2, 3 « Component Assemblies » - Type 4 Component Assemblies having, in addition to the limited end-of-life short circuit current tests, passed all the other end-of-life tests (under the short circuit current of 100A, 500A, 1000A and SCCR) and also with (2CA) or without (1CA) external short circuit protection

Type 5 - Discrete component surge suppressors, such as MOVs, Diode or GDT that may be mounted on a PCB, connected by its leads or provided within an enclosure with mounting means and wiring terminations.

ANSI/IEEE Guide:

ANSI/IEEE publishes different informative guides regarding the risk of transient overvoltages to low voltage networks (IEEE C62.41.1), the surge environment and types of transients (IEEE C62.41.2) as well as the method for testing equipment against transients that are connected to the low voltage network (IEEE C62.45). Another important guideline detailing the installation of SPDs is IEEE C62.72.

IEEE C62.41.2 Guide

IEEE C62.41.2 Guide provides the selection of performance surge arresters according to their location in the system.

Categories depending on the location following IEEE C62.41.2 Guide

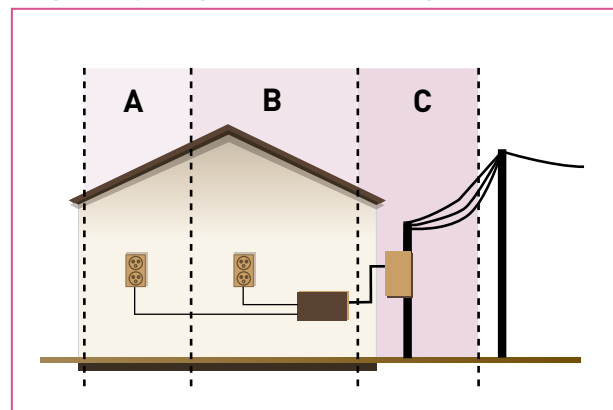

Selection of surge protector following IEEE C62.41.2 Guide

Categories of location		Minimum withstand of recommended arresters	
		Voltage 1,2/50 μ s	Current 8/20 μ s
A	Indoor installation	6 kV	0.5 kA
B	Entry installation	6 kV	3 kA
C	Outdoor installation, low exposure	6 kV	6 kA
C	Outdoor installation, high exposure	10 kV	10 kA

PLUGGABLE DAC RANGE FROM CITEL

Application field



Application in standard electrical cabinets in compliance with international standard.

DIN Rail mounting



Slide the surge protector into the rail, and press until the unit fits and snaps.

Uninstall

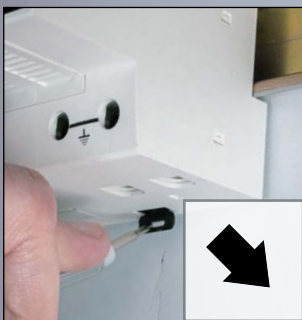

Pull the assembly clamp, and remove the device.

A PLUGGABLE DESIGN

The design of DAC surge protectors is based on the use of a **module to be plugged** into a matching base. This makes **replacement and checking very easy** without impairing your protection.

For multipole surge protectors, the possibility of **replacing a single pole makes repairing a surge protector less expensive**.

The plug-in module is identified with a color label in relation with the type (grey = Type 1 ; red = Type 2 ; blue = low power Type 2 or Type 3) and are keyed for operating voltage, in order to **avoid misapplications**.

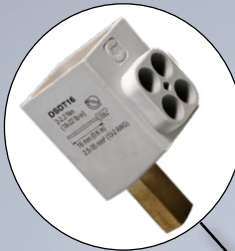

DSDT16

Option for mounting in series (see page 62)



Plug-in module

Marked with technical characteristics.

QR code tag for installation instruction download

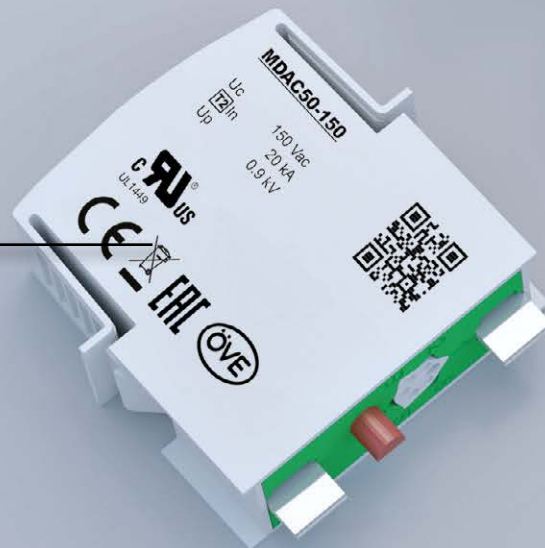



Identified connections

All connections are identified to avoid wiring mistakes.

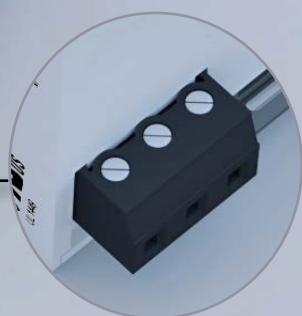

Remote signaling

Less wiring thanks to a single remote signaling connector for all poles.

Locking feature

On some versions, the pluggable module is locked in position through dedicated clips.

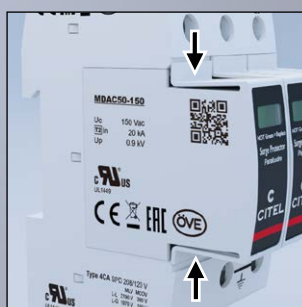

Signaling



Defective modules are identified by red indicator in the front window. It is then necessary to replace them

Spare module



Easy module replacement, requiring no tools, thanks to the pluggable feature.

Module keying



Mistake-free replacement thanks to an explicit and mechanical codification for the different operating voltages.

TYPE 1+2 AND TYPE 1+2+3 SURGE PROTECTORS

Type 1+2 and Type 1+2+3 surge protectors are heavy duty devices, designed to be installed at the origin of the AC installations equipped with LPS (Lightning Protection System). They are necessary to protect sensitive equipment connected to AC network against indirect effects of lightning, and even in case of direct strike. Following the different national electrical codes, these SPDs can be recommended or mandatory, especially in case of LPS on the building. These surge protectors are tested following Class I tests from IEC 61643-11, characterized by 10/350 μ s lightning current injections.

These surge protectors are available in a wide range of versions to be adaptable to all configurations :

- Iimp by pole : 12.5, 25 and 50 kA
- Total Iimp : up to 100 kA
- Single, 3 or 3-Phase+Neutral AC network
- 230/400 V, 120/208 V and 690 V AC network
- All AC system types
- Common mode protection (CT1 configuration) or Common and Differential mode protection (CT2 configuration)

Several mechanical formats are available to meet the needs of the user: assembled unipolar units, monobloc device or multipole equipped with pluggable modules.

These multipolar SPDs are using 2 different technologies:

- DS250VG, DAC1-13VG, DUT250VG: «VG» technology,
- DS500E, DS250E, DAC1-13: «MultiMOV» technology.







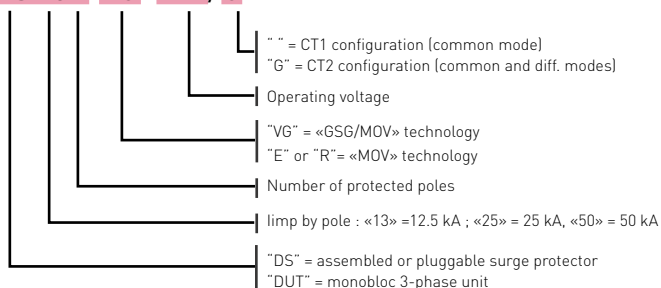

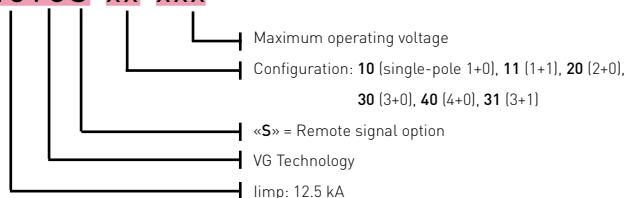

PART NUMBER INFORMATION

DS254 VG-xxx/G



DAC1-13VGS-xx-xxx



Range		Description	limp by pole (10/350 µs)	Characteristics	Page
DS250VG		1-pole reinforced surge protector - VG Technology	25 kA	Very high energy Very high efficiency	31
DS250E		1-pole reinforced surge protector - VG Technology	25 kA	Very high energy	33
DS500E		1-pole reinforced surge protector	50 kA	Very high energy	35
DACN1-25VGS		1-pole surge protector VG Technology	25 kA	Very high energy	37
DUT250VG		3-phase surge protector VG Technology	25 kA	Compact Very high energy Very high efficiency	39
DAC1-13VG		Pluggable surge protector VG Technology	12.5 kA	Compact, Pluggable, Very high efficiency	41
ZPAC1		3-phase SPD for busbar mounting	12.5 kA or 8 kA	Specific mounting on 40 mm busbar system	43
DAC1-13		Pluggable surge protector	12.5 kA	Compact Pluggable	45



DS250VG-300

DS250VG SERIES

- Type 1 + 2 + 3 Surge protector
- limp: 25 kA on 10/350 μ s impulse
- Low Up level
- Internal disconnection, status indicator and remote signaling
- Optimized to TOV
- IEC 61643-11 and EN 61643-11 compliance
- UL 1449 ed. 4 recognized

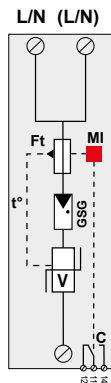
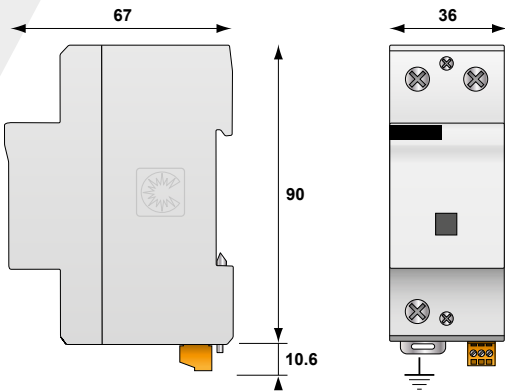

V: High energy varistor network
 GSG: Specific gas Tube
 MI: Disconnection indicator
 Ft: Thermal fuse
 t*: Thermal disconnection system
 C: Contact for remote signal

Characteristics

CITEL Model		DS250VG-400	DS250VG-300	DS250VG-120
Description		Type 1+2+3 AC surge protector 1-pole		
Network		230/400 V	230/400 V	120/208 V
Max. AC operating voltage	Uc	440 Vac	255 Vac	150 Vac
Temporary Over Voltage (TOV) Characteristics - 5 sec.	UT	580 Vac withstand	335 Vac withstand	180 Vac withstand
Temporary Over Voltage (TOV) Characteristics - 120 mn	UT	770 Vac withstand	440 Vac withstand	230 Vac withstand
Residual current - Leakage current at Uc	Ipe	None	None	None
Max. Load current (if connection serie)	IL	100 A	100 A	100 A
Follow current	If	None	None	None
Nominal discharge current 15 x 8/20 μ s impulses	In	30 kA	30 kA	30 kA
Max. discharge current max. withstand @ 8/20 μ s by pole	I _{max}	70 kA	70 kA	70 kA
Impulse current by pole max. withstand 10/350 μ s	limp	25 kA	25 kA	25 kA
Specific energy by pole	W/R	156 kJ/ohm	156 kJ/ohm	156 kJ/ohm
Withstand on Combination waveform Class III test	Uoc	20 kV	20 kV	20 kV
Protection level @ In (8/20 μ s) and 6 kV (1.2/50 μ s)	Up	1.5 kV	1.5 kV	1 kV
Residual voltage @ 5kA (8/20 μ s)	Up-5kA	1 kV	0.6 kV	0.4 kV
Admissible short-circuit current	Isc _{ccr}	50000 A	50000 A	50000 A
Associated disconnectors				
Thermal disconnector		internal		
Fuses		Fuses type gG - 315 A / or CITEL SFD-25		
Installation ground fault breaker (if required)		Type «S» or delayed		
Mechanical characteristics				
Dimensions		see diagram		
Connection to Network		By screw terminals : 6-35 mm ² / by bus		
Disconnection indicator		1 mechanical indicator		
Remote signaling of disconnection		output on changeover contact		
Mounting		Symmetrical rail 35 mm (EN60715)		
Operating temperature		-40/+85°C		
Protection rating		IP20		
Housing material		Thermoplastic UL94 V-0		
Standards				
Compliance		IEC 61643-11 / EN 61643-11 / UL1449 ed.4		
Certification		EAC	UL / CSA / EAC	UL / EAC
Part number				
		2578	2577	2787

TYPE 1 + 2 + 3 AC MULTIPOLAR SURGE PROTECTOR

DS252VG, DS253VG, DS254VG



DS254VG-300/G

DS25x VG-xxx/G

- " " = CT1 configuration (common mode)
- "G" = CT2 configuration (common and diff. mode)
- Operating/nominal voltage
- "VG" = «GSG/MOV» technology
- Number of protected poles

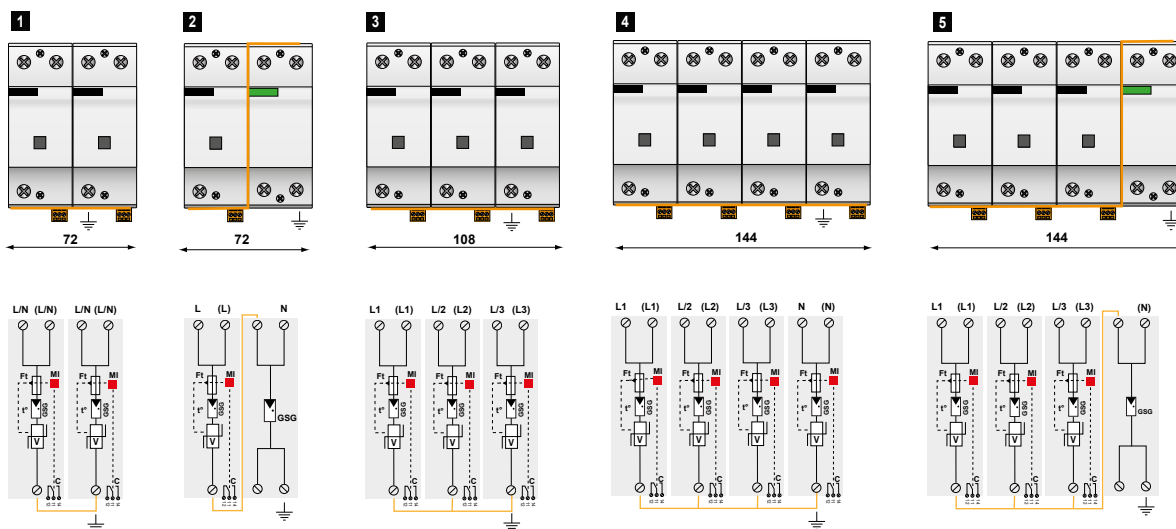

- V: High energy varistor network
- GSG: Specific gas Tube
- Ft: Thermal fuse
- C: Remote signaling contact
- t°: Thermal disconnection system
- MI: Disconnection indicator

Model	P/N	Network	AC system	Protection Mode	Itotal	Up L/PE	Up L/N	Up N/PE	Diagram
DS254VG-300/G	2756	230/400 V 3-phase+N	TT-TNS	L/N and N/PE	100 kA	-	1.5 kV	1.5 kV	6
DS254VG-120/G	2757	120/208 V 3-phase+N	TT-TNS	L/N and N/PE	100 kA	-	1 kV	1.5 kV	
DS254VG-400	2581	230/400 V 3-phase+N	IT	L/PE and N/PE	100 kA	1.5 kV	-	1.5 kV	5
DS254VG-300	3713	230/400 V 3-phase+N	TNS	L/PE and N/PE	100 kA	1.5 kV	-	1.5 kV	
DS254VG-120	3722	120/208 V 3-phase+N	TNS	L/PE and N/PE	100 kA	1 kV	-	1 kV	3
DS253VG-400	2580	230/400 V 3-phase	IT	L/PE	75 kA	1.5 kV	-	-	
DS253VG-300	3896	230/400 V 3-phase	TNC	L/PE	75 kA	1.5 kV	-	-	1
DS253VG-120	3959	120/208 V 3-phase	TNC	L/PE	75 kA	1 kV	-	-	
DS252VG-300/G	3403	230 V single phase	TT-TN	L/N and N/PE	50 kA	-	1.5 kV	1.5 kV	2
DS252VG-120/G	3960	120 V single phase	TT-TN	L/N and N/PE	50 kA	-	1 kV	1.5 kV	
DS252VG-400	2579	230 V single phase	IT	L/PE and N/PE	50 kA	1.5 kV	-	1.5 kV	1
DS252VG-300	3469	230 V single phase	TN	L/PE and N/PE	50 kA	1.5 kV	-	1.5 kV	
DS252VG-120	3950	120 V single phase	TN	L/PE and N/PE	50 kA	1 kV	-	1 kV	



DS250E-300

DS250E SERIES



- Type 1 + 2 Surge Protector
- limp : 25 kA on 10/350 μ s impulse
- I_{max} : 140 kA on 8/20 μ s impulse
- Internal disconnections, status indicators and remote signaling
- IEC 61643-11, EN 61643-11 and UL1449 ed.4 compliance

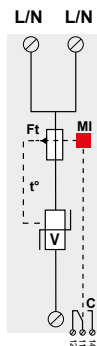
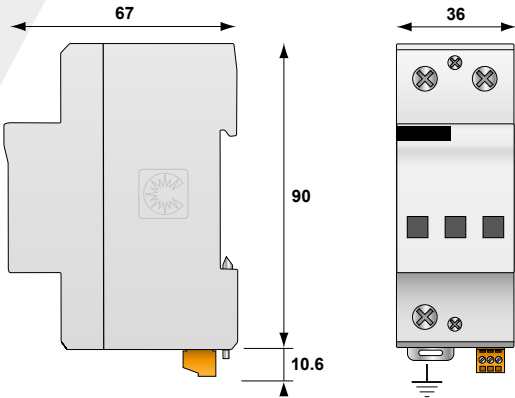

V: High energy varistor network
MI: Disconnection indicator
Ft: Thermal fuse
t°: Thermal disconnection system
C: Contact for remote signal

Characteristics

CITEL Model		DS250E-400	DS250E-300	DS250E-120
Description		Type 1+2 AC surge protector 1-pole		
Network		230/400 V	230/400 V	120/208 V
Max. AC operating voltage	U _c	440 Vac	330 Vac	150 Vac
Temporary Over Voltage (TOV) Characteristics - 5 sec.	UT	580 Vac withstand	335 Vac withstand	180 Vac withstand
Temporary Over Voltage (TOV) Characteristics - 120 mn	UT	770 Vac disconnection	440 Vac disconnection	230 Vac disconnection
Residual current - Leakage current at U _c	I _{pe}	< 3 mA	< 3 mA	< 3 mA
Max. Load current (if connection serie)	I _L	100 A	100 A	100 A
Follow current	I _f	None	None	None
Nominal discharge current 15 x 8/20 μ s impulses	I _n	50 kA	70 kA	70 kA
Max. discharge current max. withstand @ 8/20 μ s by pole	I _{max}	140 kA	140 kA	140 kA
Impulse current by pole max. withstand 10/350 μ s	limp	25 kA	25 kA	25 kA
Specific energy by pole	W/R	156 kJ/ohm	156 kJ/ohm	156 kJ/ohm
Protection level @ I _n (8/20 μ s)	U _p	2.5 kV	2.5 kV	1 kV
Residual voltage @ 5 kA (8/20 μ s)	U _{p-5kA}	1.5 kV	1 kV	0.6 kV
Admissible short-circuit current	I _{sc}	50000 A	50000 A	50000 A
Associated disconnectors				
Thermal disconnector		internal		
Fuses		Fuse type gG - 315 A / or CITEL SFD-25		
Installation ground fault breaker (if existing)		Type «S» or delayed		
Mechanical characteristics				
Dimensions		see diagram		
Connection to Network		By screw terminals : 6-35 mm ² / by bus		
Disconnection indicator		3 mechanical indicators		
Remote signaling of disconnection		output on changeover contact		
Mounting		Symmetrical rail 35 mm (EN60715)		
Operating temperature		-40/+85°C		
Protection rating		IP20		
Housing material		Thermoplastic UL94 V-0		
Standards				
Compliance		IEC 61643-11 / EN 61643-11 / UL1449 ed.4		
Certification		EAC		
Part number				
		3731	2730	3106

TYPE 1 + 2 MULTIPOLAR AC SURGE PROTECTOR

DS252E, DS253E, DS254E



DS254E-300/G

DS25x E-xxx/G

- « » = Configuration CT1 (common mode)
- «G» = Configuration CT2 (common and differential mode)
- Operating voltage
- «E» = «Multi-Varistor» technology
- Number of protected poles (2, 3 or 4)

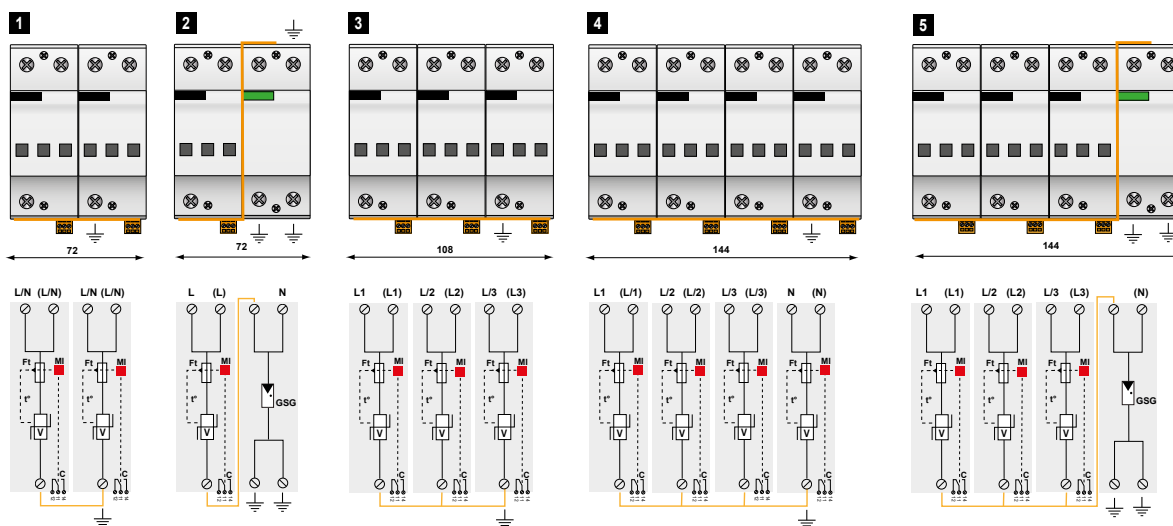

- V : High energy varistor network
- GSG : Specific gas Tube
- Ft : Thermal fuse
- C : Remote signaling contact
- t° : Thermal disconnection system
- MI : Disconnection indicator

Model	P/N	Network	AC system	Protection Mode	I _{total}	Up L/PE	Up L/N	Up N/PE	Diagram
DS254E-300/G	3411	230/400 V 3-phase+N	TT-TNS	L/N and N/PE	100 kA	-	2.5 kV	1.5 kV	5
DS254E-120/G	3831	120/208 V 3-phase+N	TT-TNS	L/N and N/PE	100 kA	-	1 kV	1.5 kV	
DS254E-400	3732	230/400 V 3-phase+N	IT	L/PE and N/PE	100 kA	2.5 kV	-	2.5 kV	4
DS254E-300	3371	230/400 V 3-phase+N	TNS	L/PE and N/PE	100 kA	2.5 kV	-	2.5 kV	
DS254E-120	3961	120/208 V 3-phase+N	TNS	L/PE and N/PE	100 kA	1 kV	-	1 kV	3
DS253E-400	3939	230/400 V 3-phase	IT	L/PE	75 kA	2.5 kV	-	-	
DS253E-300	3350	230/400 V 3-phase	TNC	L/PE	75 kA	2.5 kV	-	-	2
DS253E-120	3887	120/208 V 3-phase	TNC	L/PE	75 kA	1 kV	-	-	
DS252E-300/G	3404	230 V 3-phase	TT-TN	L/N and N/PE	50 kA	-	2.5 kV	1.5 kV	1
DS252E-120/G	3904	120 V single phase	TT-TN	L/N and N/PE	50 kA	-	1 kV	1.5 kV	
DS252E-400	3952	230 V single phase	IT	L/PE and N/PE	50 kA	2.5 kV	-	2.5 kV	1
DS252E-300	3962	230 V single phase	TN	L/PE and N/PE	50 kA	2.5 kV	-	2.5 kV	
DS252E-120	3951	120 V single phase	TN	L/PE and N/PE	50 kA	1 kV	-	1 kV	



DS500E-400

DS500E SERIES



- Type 1 + 2 surge protector
- limp: 50 kA on 10/350 μ s impulse
- I_{max}: 200 kA on 8/20 μ s impulse
- Internal disconnection with indicator
- Remote signaling
- EN 61643-11, IEC 61643-11 compliance

Characteristics

CITEL Model		DS500E-400	DS500E-320	DS500E-230
Description		Type 1+2 AC surge protector 1-pole		
Network		230/400 V	230/400 V	230/400 V
Max. AC operating voltage	U _c	440 Vac	320 Vac	255 Vac
Temporary Over Voltage (TOV) Characteristics - 5 sec.	UT	580 Vac withstand	335 Vac withstand	335 Vac withstand
Temporary Over Voltage (TOV) Characteristics - 120 mn	UT	770 Vac disconnection	440 Vac disconnection	440 Vac disconnection
Residual current Leakage current at U _c	I _{pe}	< 3 mA	< 3 mA	< 3 mA
Max. Load current (if connection serie)	IL	100 A	100 A	100 A
Follow current	I _f	None	None	None
Nominal discharge current 15 x 8/20 μ s impulses	I _n	50 kA	50 kA	50 kA
Max. discharge current max. withstand @ 8/20 μ s by pole	I _{max}	200 kA	200 kA	200 kA
Impulse current by pole max. withstand 10/350 μ s	I _{imp}	50 kA	50 kA	50 kA
Specific energy by pole	W/R	625 kJ/ohm	625 kJ/ohm	625 kJ/ohm
Protection level @ I _n (8/20 μ s)	U _p	2.2 kV	1.8 kV	1.8 kV
Residual voltage @ 5kA (8/20 μ s)	U _{p-5kA}	1.3 kV	0.9 kV	0.8 kV
Admissible short-circuit current	I _{sc}	50000 A	50000 A	50000 A
Associated disconnectors				
Thermal disconnector		internal		
Fuses		Fuses Type gG - 500 A		
Installation ground fault breaker		Type «S» or delayed		
Mechanical characteristics				
Dimensions		see diagram		
Connection to Network		By screw terminals : 6-35 mm ²		
Disconnection indicator		1 mechanical indicator		
Remote signaling of disconnection		output on changeover contact		
Mounting		Symmetrical rail 35 mm (EN60715)		
Operating temperature		-40/+85°C		
Protection rating		IP20		
Housing material		Thermoplastic UL94 V-0		
Standards				
Compliance		IEC 61643-11 / EN 61643-11		
Certification		EAC		
Part number				
		3964	63166	500230

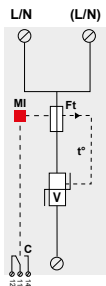
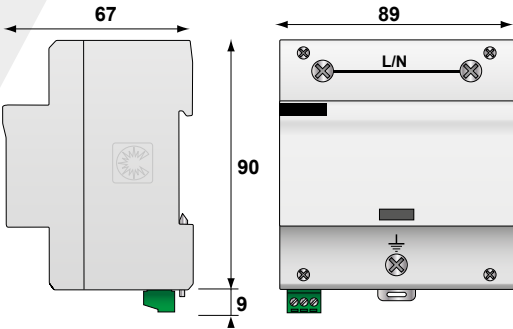

V: High energy varistor network
 MI: Disconnection indicator
 Ft: Thermal fuse
 t°: Thermal disconnection system
 C: Contact for remote signal

TYPE 1 + 2 MULTIPOLAR AC SURGE PROTECTOR

DS502E, DS503E, DS504E



DS502E-230/G

DS50x E-xxx/G

- « » = Configuration CT1 (common mode)
- «G» = Configuration CT2 (common and differential mode)
- Operating/nominal voltage
- «E» = «Multi-Varistor» technology
- Number of protected poles (2, 3 or 4)

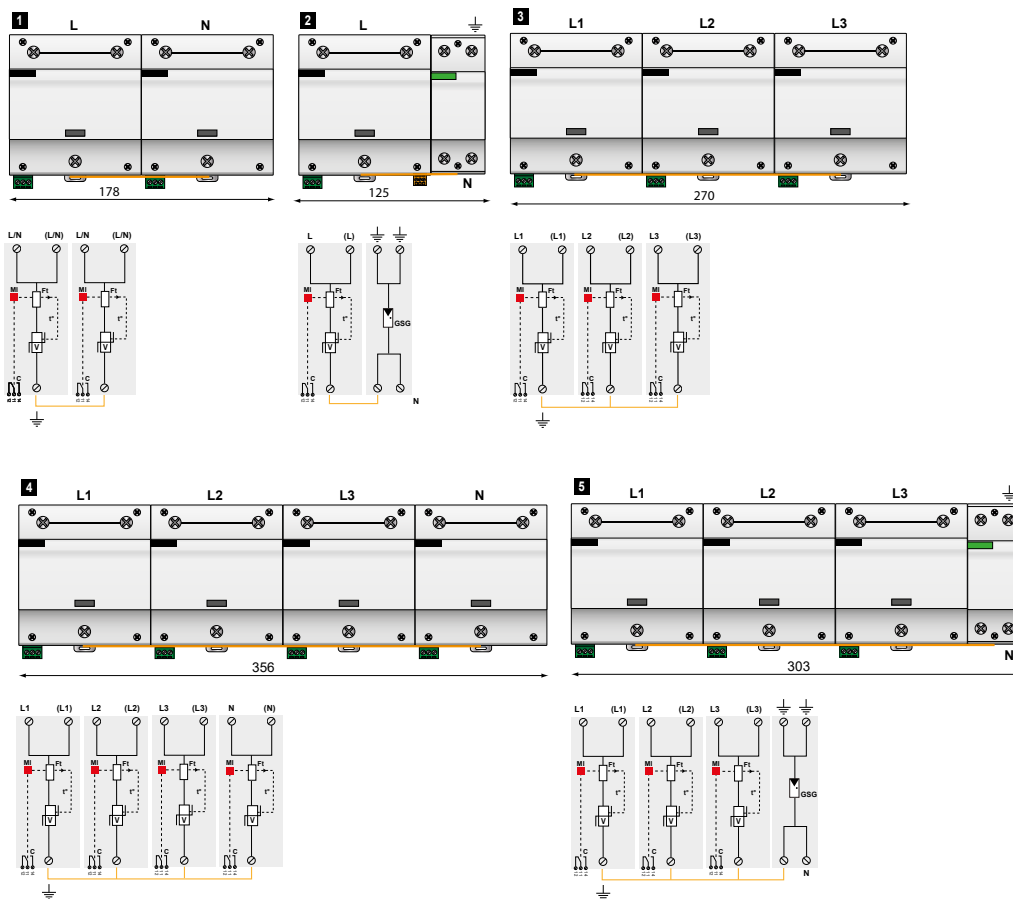

V: High energy varistor network
 GSG : Specific gas Tube
 Ft: Thermal fuse
 C: Remote signaling contact
 t°: Thermal disconnection system
 MI: Disconnection indicator

Model	P/N	Network	AC system	Protection Mode	I _{total}	Up L/PE	Up L/N	Up N/PE	Diagram
DS504E-320/G	64017	230/400 V 3-phase+N	TT-TNS	L/N et N/PE	100 kA	-	1.8 kV	1.5 kV	5
DS504E-230/G	5042301	230/400 V 3-phase+N	TT-TNS	L/N et N/PE	100 kA	-	1.8 kV	1.5 kV	
DS504E-400	64020	230/400 V 3-phase+N	IT	L/PE and N/PE	200 kA	2.2 kV	-	2.2 kV	4
DS504E-320	504320	230/400 V 3-phase+N	TNS	L/PE and N/PE	200 kA	1.8 kV	-	1.8 kV	
DS504E-230	64021	230/400 V 3-phase+N	TNS	L/PE and N/PE	200 kA	1.8 kV	-	1.8 kV	3
DS503E-400	3965	230/400 V 3-phase	IT	L/PE	150 kA	2.2 kV	-	-	
DS503E-320	64023	230/400 V 3-phase	TNC	L/PE	150 kA	1.8 kV	-	-	2
DS503E-230	64024	230/400 V 3-phase	TNC	L/PE	150 kA	1.8 kV	-	-	
DS502E-320/G	64026	230 V single phase	TT-TN	L/N et N/PE	100 kA	-	1.8 kV	1.5 kV	1
DS502E-230/G	5022301	230 V single phase	TT-TN	L/N and N/PE	100 kA	-	1.8 kV	1.5 kV	
DS502E-400	64028	230 V single phase	IT	L/PE and N/PE	100 kA	2.2 kV	-	2.2 kV	1
DS502E-320	64029	230 V single phase	TN	L/PE et N/PE	100 kA	1.8 kV	-	1.8 kV	
DS502E-230	64030	230 V single phase	TN	L/PE and N/PE	100 kA	1.8 kV	-	1.8 kV	



DACN1-25VGS-760

DACN1-25VGS-760 SERIES

- Type 1 + 2 + 3 Surge Protector
- for 690 V AC Network
- VG Technology
- In : 35 kA
- limp : 25 kA
- Remote signaling
- Optimized to TOV
- EN 61643-11, IEC 61643-11, UL1449 ed.4 and GB/T 18802.1 compliance

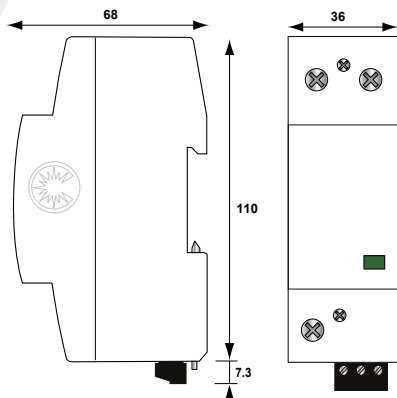

Electrical diagram for 1 pole

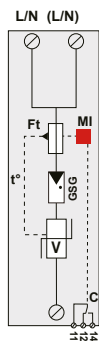

V: High energy varistor
GSG: Specific gas Tube
MI: Disconnection indicator
Ft: Thermal fuse
t°: Thermal disconnection system
C: Contact for remote signal

Characteristics

CITEL model		DACN1-25VGS-10-760
Description		Type 1+2+3 AC surge protector - 1-pole
Max. AC operating voltage	Uc	760 Vac
Temporary Over Voltage (TOV) characteristics - 5 sec	UT	1000 Vac
Temporary Over Voltage (TOV) characteristics - 20 mn	UT	1325 Vac
Residual current - Leakage current at Uc	Ipe	none
Max. Load current (if connection serie)	IL	100 A
Follow current	If	none
Nominal discharge current <i>15 x 8/20µs impulses</i>	In	35 kA
Maximal discharge current <i>max. withstand @ 8/20 µs</i>	I _{max}	70 kA
Impulse current by pole <i>max. withstand @ 10/350 µs by pole</i>	limp	25 kA
Specific energy by pole	W/R	156 kJ/ohm
Withstand on combination waveform <i>Class III test</i>	Uoc	6 kV
Protection level <i>@ In (8/20µs) et 6 kV (1.2/50µs)</i>	Up	2.5 kV
Residual voltage @ 25kA (8/20µs)	Up-25kA	2.1 kV
Residual voltage @ 5kA (8/20µs)	Up-5kA	1.6 kV
Admissible short-circuit current	I _{sc}	50 000 A
Associated disconnectors		
Thermal disconnector		internal
Fuses		Fuse type gG - 315 A
Existing upstream ground breaker (if any)		Type «S» or delayed
Mechanical characteristics		
Dimensions		see diagram, 2 TE (DIN43880)
Connection to network		by screw terminals : 2.5-25 mm ² (35mm ² rigid)
Disconnection indicator		1 mechanical indicator Green/Red
Remote signaling of disconnection		output on changeover contact
Failsafe mode		Disconnection from AC network
Max. voltage/current for remote signaling		250 V/0.5 A (AC), 30 V/3 A (DC)
Wiring for remote signaling		1.5 mm ² max.
Mounting		Symmetrical rail 35 mm ² (EN60715)
Operating temperature		-40/+85°C
Protection rating		IP20
Housing material		Thermoplastic UL94 V-0
Standards		
Compliance		IEC 61643-11 / NF EN 61643-11 / UL1449 ed.4 / GB/T 18802.1
Certification		TUV Rheinland
Code Article		
		29221012

TYPE 1 + 2 + 3 MULTIPOLAR AC SURGE PROTECTORS

DACN1-25VGS-20, DACN1-25VGS-30, DACN1-25VGS-40



DACN1-25VGS-xx-xxx

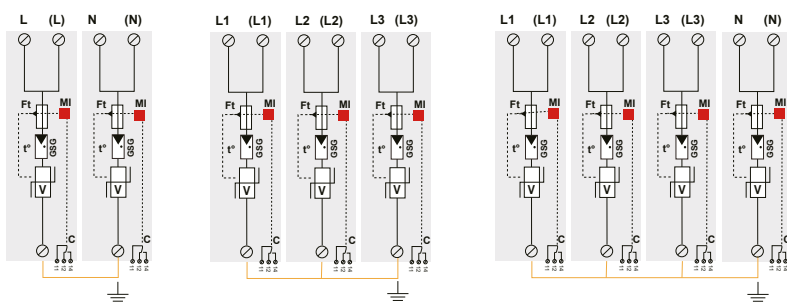
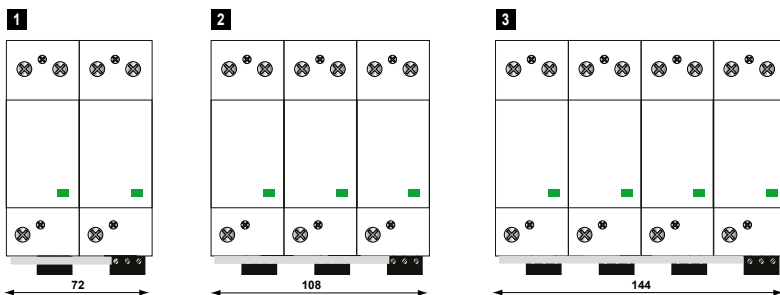
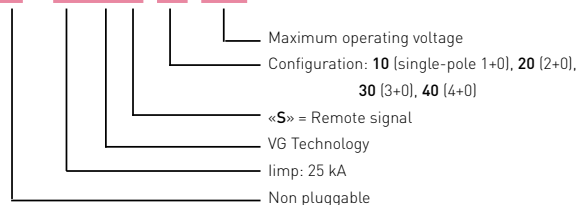

V: High energy varistor
GSG: Specific gas Tube
MI: Disconnection indicator
Ft: Thermal fuse
t°: Thermal disconnection system
C: Contact for remote signal

Model	P/N	Network	AC System	Protection Mode	limp total	Up L/PE	Up N/PE	Dimension DIN43880	Diagram
DACN1-25VGS-40-760	29224012	400/690 V 3-phase+N	TN System (4+0)	L/PE and N/PE	100 kA	2.5 kV	2.5 kV	8TE	3
DACN1-25VGS-30-760	29223012	400/690 V 3-phase	TN-C System (3+0)	L/PE	75 kA	2.5 kV	-	6TE	2
DACN1-25VGS-20-760	29222012	400 V Single phase	IT System (2+0)	L/PE and N/PE	50 kA	2.5 kV	2.5 kV	4 TE	1



DUT250VG-300/G



DUT250VG-300 SERIES



- Type 1 + 2 + 3, 3-phase surge protector
- Common and Differential mode
- Very compact monobloc enclosure
- limp by pole: 25 kA
- Internal disconnection, status indicator
- Optimized to TOV
- EN 61643-11, IEC 61643-11 and UL1449 ed.4 compliance

Characteristics

CITEL Model		DUT250VG-300/G	DUT250VG-300/TNS	DUT250VG-300/TNC
Description		Type 1+2+3 AC surge protector - 3-phase+N	Type 1+2+3 AC - 3-phase	Type 1+2+3 AC - 3-phase
Network		230/400 V	230/400 V	230/400 V
AC system		TT-TNS	TNS	TNC
Max. AC operating voltage	Uc	255 Vac	255 Vac	255 Vac
Temporary Over Voltage (TOV) Characteristics - 5 sec.	UT	335 Vac withstand	335 Vac withstand	335 Vac withstand
Temporary Over Voltage (TOV) Characteristics - 120 mn	UT	440 Vac withstand	440 Vac withstand	440 Vac withstand
Temporary Over Voltage N/PE (TOV HT)	UT	1200 V/300A/200 ms withstand	-	-
Residual current - Leakage current at Uc	Ipe	None	None	None
Follow current	If	None	None	None
Nominal discharge current - 15 x 8/20 μs impulses	In	40 kA	40 kA	40 kA
Max. discharge current - max. withstand @ 8/20 μs by pole	I _{max}	100 kA	100 kA	100 kA
Impulse current by pole - max. withstand 10/350 μs	I _{limp}	25 kA	25 kA	25 kA
Total lightning current - max. total withstand @ 10/350 μs	I _{total}	50 kA	50 kA	75 kA
Specific energy by pole	W/R	156 kJ/ohm	156 kJ/ohm	156 kJ/ohm
Withstand on Combination waveform - Class III test	Uoc	6 kV	6 kV	6 kV
Protection level L/N @ In (8/20 μs) and @ 6 kV (1.2/50 μs)	Up	1.5 kV	1.5 kV	-
Protection level N/PE @ In (8/20 μs) and @ 6 kV (1.2/50 μs)	Up	1.5 kV	1.5 kV	-
Protection level L/PE @ In (8/20 μs) and @ 6 kV (1.2/50 μs)	Up	-	-	1.5 kV
Admis. short-circuit current	I _{scrr}	50000 A	50000 A	50000 A
Associated disconnectors				
Thermal disconnector		internal		
Fuses		Fuses type gG - 315 A / or CITEL SFD-25		
Installation ground fault breaker		Type «S» or delayed		
Mechanical characteristics				
Dimensions		see diagram - 1TE (DIN43880)		
Connection to Network		By screw terminals : 6-35 mm ² / by bus		
Disconnection indicator		3 Led indicators		
Remote signaling of disconnection		none		
Mounting		Symmetrical rail 35 mm (EN60715)		
Operating temperature		-40/+85°C		
Protection rating		IP20		
Housing material		Thermoplastic UL94 V-0		
Standards				
Compliance		IEC 61643-11 / EN 61643-11 / UL1449 ed.4		
Certification		EAC		
Part number				
		3414	3597	3588

TYPE 1 + 2 + 3 AC SURGE PROTECTOR

DUT250VG-300/G, DUT250VG-300/TNS, DUT250VG-300/TNC

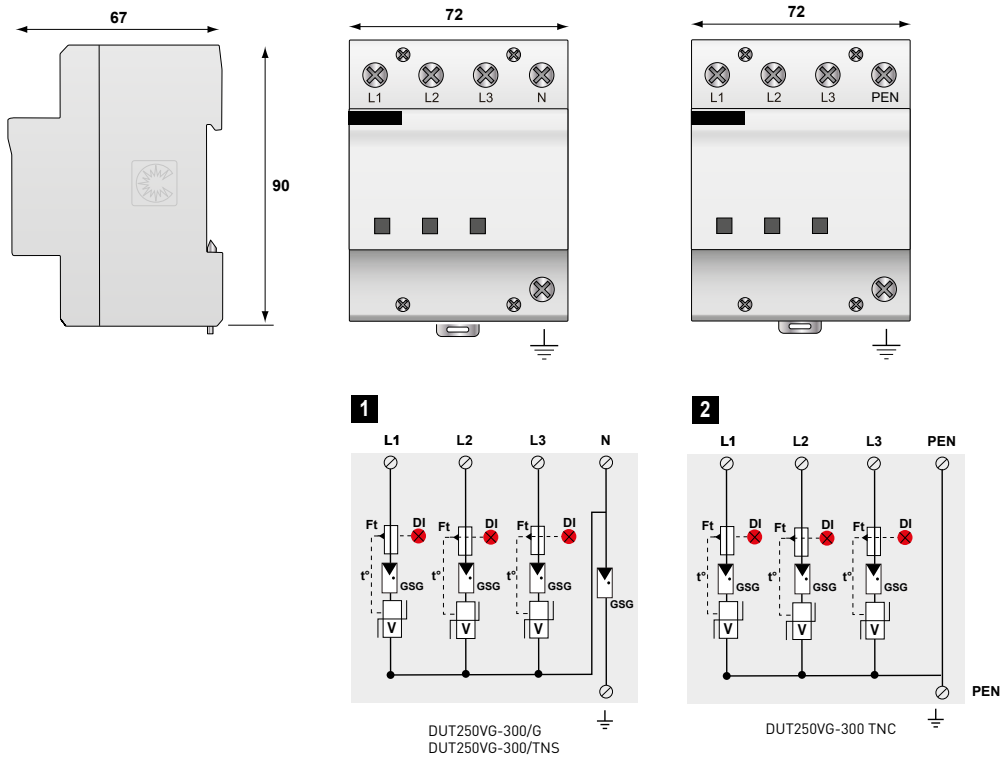

Model	P/N	Network	AC system	Protection Mode	I _{total}	Up L/PE	Up L/N	Up N/PE	Dimension DIN43880	Diagram
DUT250VG-300/G	3414	230/400 V 3-Phase+N	TT-TNS System (3+1)	L/N and N/PE	50 kA	-	1.5 kV	1.5 kV	4 TE	1
DUT250VG-300/TNS	3597	230/400 V 3-Phase+N	TNS System (3+1)	L/N and N/PE	50 kA	-	1.5 kV	1.5 kV	4 TE	1
DUT250VG-300/TNC	3588	400 V 3-Phase	TNC System (3+0)	L/PE	50 kA	-	1.5 kV	1.5 kV	4 TE	2



DAC1-13VG SERIES



- VG Technology
- In: 20 kA
- limp: 12.5 kA
- No leakage current
- Pluggable module for each phase
- Remote signaling (option)
- Optimized to TOV
- EN 61643-11, IEC 61643-11 certified
- UL1449 ed.4 compliance

DAC1-13VG-10

Characteristics

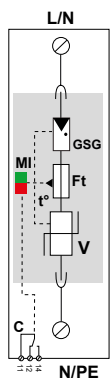
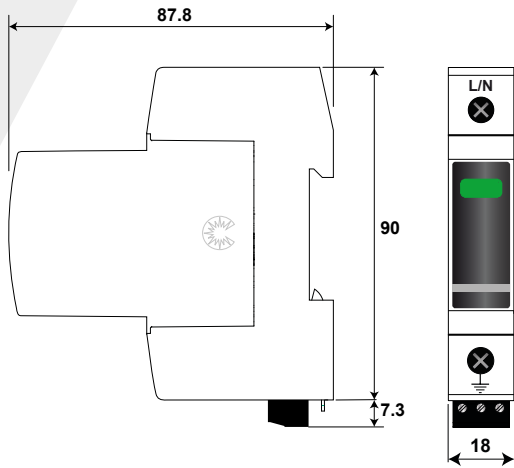

V: High energy varistor
 GSG: Specific gas Tube
 MI: Disconnection indicator
 Ft: Thermal fuse
 t°: Thermal disconnection system
 C: Contact for remote signal

CITEL Model		DAC1-13VG-10-320	DAC1-13VG-10-275	DAC1-13VG-10-150
Description		Type 1+2+3 AC surge protector - 1-pole - pluggable		
Max. AC operating voltage	Uc	320 Vac	275 Vac	150 Vac
Temporary Over Voltage (TOV) characteristic - 5 sec.	UT	335 Vac withstand	335 Vac withstand	180 Vac withstand
Temporary Over Voltage (TOV) characteristic - 120 mn	UT	440 Vac withstand	440 Vac withstand	230 Vac withstand
Residual current - Leakage current at Uc	Ipe	None	None	None
Follow current	If	None	None	None
Nominal discharge current 15 x 8/20 μs impulses	In	20 kA	20 kA	20 kA
Max. discharge current max. withstand @ 8/20 μs by pole	Imax	50 kA	50 kA	50 kA
Impulse current by pole max. withstand 10/350μs	limp	12.5 kA	12.5 kA	12.5 kA
Specific energy by pole	W/R	40 kJ/ohm	40 kJ/ohm	40 kJ/ohm
Withstand on Combination waveform Class III test	Uoc	6 kV	6 kV	6 kV
Protection level @ In (8/20μs) and 6 kV (1.2/50μs)	Up	1.5 kV	1.5 kV	1.5 kV
Residual Voltage @ 5 kA (8/20μs)	Up-5kA	0.9 kV	0.7 kV	0.4 kV
Admissible short-circuit current	Isc cr	50 000 A	50 000 A	50 000 A

Associated disconnectors	
Thermal disconnector	Internal
Fuses	125 A min. - 315 A max. - gG type / or CITEL SFD-13
Existing upstream ground fault breaker (if any)	Type «S» or delayed

Mechanical characteristics	
Dimensions	see diagram - 1TE (DIN43880)
Connection to Network	By screw terminals: 2.5-25 mm ² (35mm ² rigid)
Failsafe Mode	Disconnection from AC network
Disconnection indicator	1 mechanical indicator Green/Red
Remote signaling of disconnection output on changeover contact	option DAC1-13VGS-10-320 option DAC1-13VGS-10-275 option DAC1-13VGS-10-150
Max. voltage/current for remote signaling	250 V/0.5 A (AC) / 30 V/3 A (DC)
Wiring for remote signaling	1.5 mm ² max.
Mounting	Symmetrical rail 35 mm (EN60715)
Operating temperature	-40/+85°C
Protection rating	IP20
Housing material	Thermoplastic UL94 V-0
Spare unit	MDAC1-13VG-320 MDAC1-13VG-275 MDAC1-13VG-150

Standards	
Certification	KEMA /EAC
Compliance	IEC 61643-11 / EN 61643-11 / UL1449 ed.4

Part number	
	821730311 821730211 821730111

TYPE 1 + 2 + 3 AC MULTIPOLAR SURGE PROTECTOR

DAC1-13VG-11, DAC1-13VG-20, DAC1-13VG-30, DAC1-13VG-31, DAC1-13VG-40



DAC1-13VG-31

DAC1-13VGS-xx-xxx

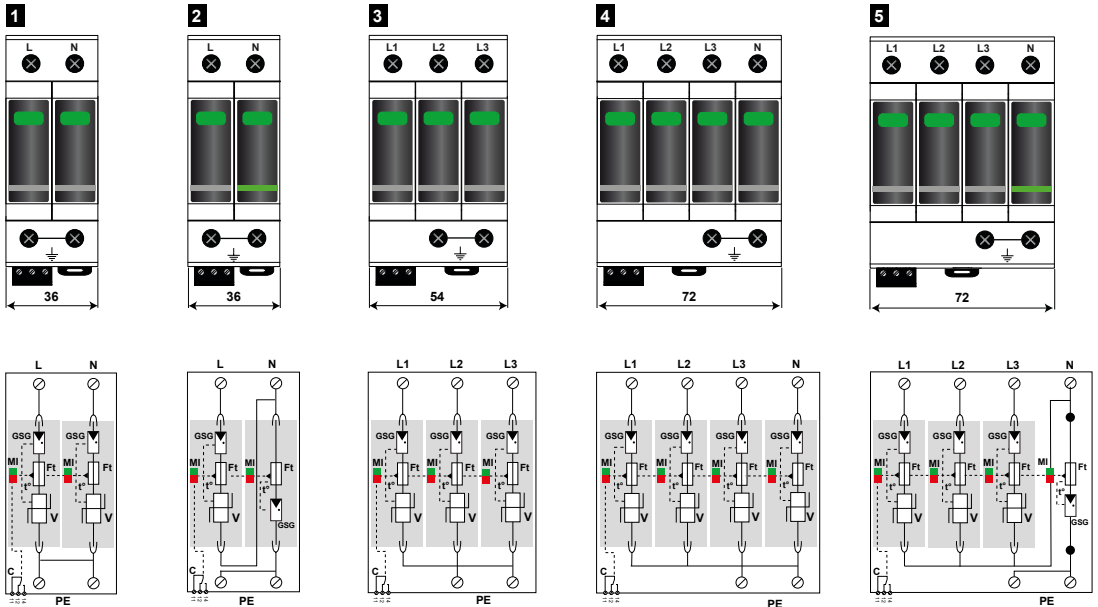
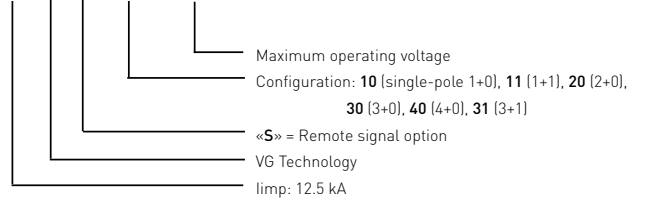

V: High energy varistor
 GSG: Specific gas Tube
 MI: Disconnection indicator
 Ft: Thermal fuse
 t°: Thermal disconnection system
 C: Contact for remote signal

Model	P/N	Network	AC system	Protection Mode	I _{total}	U _p L/PE	U _p L/N	U _p N/PE	Dimension DIN43880	Diagram
DAC1-13VG-31-320	821730334	230/400 V 3-Phase+N	TT-TNS System (3+1)	L/N and N/PE	50 kA	-	1.5 kV	1.5 kV	4 TE	5
DAC1-13VG-31-275	821730234	230/400 V 3-Phase+N	TT-TNS System (3+1)	L/N and N/PE	50 kA	-	1.5 kV	1.5 kV	4 TE	
DAC1-13VG-31-150	821730134	120/208 V 3-Phase+N	TT-TNS System (3+1)	L/N and N/PE	50 kA	-	1.5 kV	1.5 kV	4 TE	
DAC1-13VG-40-320	821730314	230/400 V 3-Phase+N	TNS System (4+0)	L/PE and N/PE	50 kA	1.5 kV	-	1.5 kV	4 TE	4
DAC1-13VG-40-275	871730214	230/400 V 3-Phase+N	TNS System (4+0)	L/PE and N/PE	50 kA	1.5 kV	-	1.5 kV	4 TE	
DAC1-13VG-40-150	821730114	120/208 V 3-Phase+N	TNS System (4+0)	L/PE and N/PE	50 kA	1.5 kV	-	1.5 kV	4 TE	3
DAC1-13VG-30-320	821730313	230/400 V 3-Phase	TNC System (3+0)	L/PE	37.5 kA	1.5 kV	-	-	3 TE	
DAC1-13VG-30-275	821730213	230/400 V 3-Phase	TNC System (3+0)	L/PE	37.5 kA	1.5 kV	-	-	3 TE	
DAC1-13VG-30-150	821730113	120/208 V 3-Phase	TNC System (3+0)	L/PE	37.5 kA	1.5 kV	-	-	3 TE	2
DAC1-13VG-11-320	821730332	230 V single phase	TT-TN System (1+1)	L/N and N/PE	25 kA	-	1.5 kV	1.5 kV	2 TE	
DAC1-13VG-11-275	821730232	230 V single phase	TT-TN System (1+1)	L/N and N/PE	25 kA	-	1.5 kV	1.5 kV	2 TE	
DAC1-13VG-11-150	821730132	120 V single phase	TT-TN System (1+1)	L/N and N/PE	25 kA	-	1.5 kV	1.5 kV	2 TE	1
DAC1-13VG-20-320	821730312	230 V single phase	TN System (2+0)	L/PE and N/PE	25 kA	1.5 kV	-	1.5 kV	2 TE	
DAC1-13VG-20-275	821730212	230 V single phase	TN System (2+0)	L/PE and N/PE	25 kA	1.5 kV	-	1.5 kV	2 TE	
DAC1-13VG-20-150	821730112	120 V single phase	TN System (2+0)	L/PE and N/PE	25 kA	1.5 kV	-	1.5 kV	2 TE	



ZPAC1 SERIES

- Type 1 + 2 + 3 AC SPD
- Mounting on 40 mm busbar system
- VG Technology
- Iimp: 12.5 kA or 8 kA
- Itotal: 50 kA or 32 kA
- No leakage current
- Optimized to TOV
- EN 61643-11, IEC 61643-11 certified
- UL1449 ed.4 compliance
- VDE-AR-N 4100 compliance



Characteristics

CITEL Model		ZPAC1-13VG-31-275	ZPAC1-8VG-31-275
Network		230/400 V 3L+N	230/400 V 3L+N
Max. AC operating voltage	Uc	275 Vac	275 Vac
Temporary Over Voltage (TOV) characteristic - 5 sec.	UT	335 Vac withstand	335 Vac withstand
Temporary Over Voltage (TOV) characteristic - 120 mn	UT	440 Vac withstand	440 Vac withstand
Temporary Over Voltage N/PE (TOV HT)	UT	1200V/300 V/200 ms withstand	1200V/300 V/200 ms withstand
Residual current - Leakage current at Uc	Ipe	None	None
Follow current	If	None	None
Nominal discharge current <i>15 x 8/20 μs impulses</i>	In	20 kA	20 kA
Max. discharge current <i>max. withstand @ 8/20 μs by pole</i>	I _{max}	50 kA	50 kA
Impulse current by pole <i>max. withstand 10/350 μs</i>	I _{imp}	12.5 kA	8 kA
Specific energy by pole	W/R	40 kJ/ohm	16 kJ/ohm
Total lightning current - @ 10/350 μs by pole	I _{total}	50 kA	32 kA
Withstand on Combination waveform <i>Class III test</i>	Uoc	6 kV	6 kV
Protection level <i>@ In (8/20 μs) and 6 kV (1.2/50 μs)</i>	Up L/N	1.5 kV	1.5 kV
	Up N/PE	1.5 kV	1.5 kV
Residual Voltage @ 5 kA (8/20 μs)	Up-5kA	0.7 kV	0.7 kV
Admissible short-circuit current	I _{sccr}	50 000 A	50 000 A
Associated disconnectors			
Thermal disconnector		Internal	
Fuses (existing upstream)		160 A max. - gG type	
Mechanical characteristics			
Dimensions		see diagram - 3TE (DIN43880)	
Connection to Network		Mounting on 40 mm busbar and wire for PE: 10-50 mm ²	
Failsafe Mode		Disconnection from AC network	
Disconnection indicator		1 mechanical indicator by pole Green/Red	
Mounting		Symmetrical rail 35 mm (EN60715)	
Operating temperature		-40/+85°C	
Protection rating		IP20	
Housing material		Thermoplastic UL94 V-0	
Spare unit		MDAC1-13VG-275	MDAC1-8VG-275
Standards			
Certification		KEMA /EAC	
Compliance		IEC 61643-11 / EN 61643-11 / UL1449 ed.4	
Part number			
		64004	64006

TYPE 1 + 2 + 3 3-PHASE AC SURGE PROTECTOR

ZPAC1-xxVG-xx-xxx

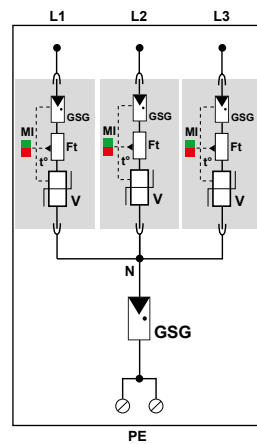
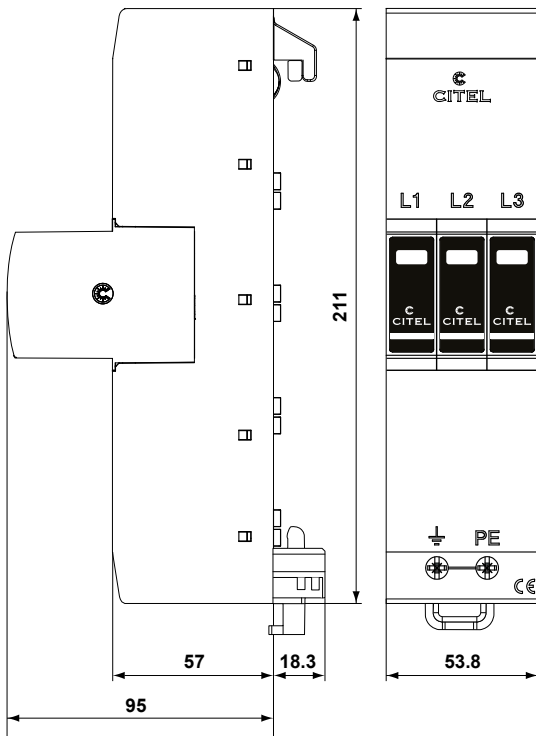
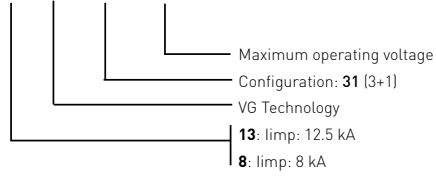

- V: High energy varistor
- GSG: Specific gas Tube
- MI: Disconnection indicator
- Ft: Thermal fuse
- t[°]: Thermal disconnection system



DAC1-13S-10

DAC1-13 SERIES



- Type 1 + 2 AC power surge protector
- In: 20 kA
- limp: 12.5 kA
- Pluggable module for each phase
- Remote signaling (option)
- EN 61643-11, IEC 61643-11 certified
- UL 1449 ed.4 compliance

Characteristics

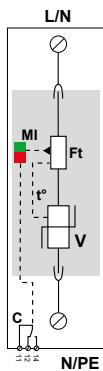
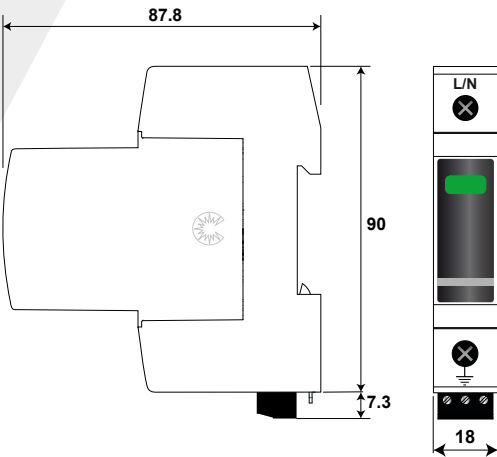

V: High energy varistor
 MI: Disconnection indicator
 Ft: Thermal fuse
 t^o: Thermal disconnection system
 C: Contact for remote signal

CITEL Model		DAC1-13-10-440	DAC1-13-10-320	DAC1-13-10-275	DAC1-13-10-150
Description		1+2 AC surge protector - 1-pole - pluggable			
Max. AC operating voltage	Uc	440 Vac	320 Vac	275 Vac	150 Vac
Temporary Over Voltage (TOV) Characteristic - 5 sec.	UT	580 Vac withstand	335 Vac withstand	335 Vac withstand	180 Vac withstand
Temporary Over Voltage (TOV) Characteristic - 120 mn	UT	770 Vac disconnection	440 Vac disconnection	440 Vac disconnection	230 Vac disconnection
Residual current Leakage current at Uc	Ipe	< 1 mA	< 1 mA	< 1 mA	< 1 mA
Follow current	If	None	None	None	None
Nominal discharge current 15 x 8/20 μs impulses	In	20 kA	20 kA	20 kA	20 kA
Max. discharge current max. withstand @ 8/20 μs by pole	I _{max}	50 kA	50 kA	50 kA	50 kA
Impulse current by pole max. withstand 10/350 μs	limp	12.5 kA	12.5 kA	12.5 kA	12.5 kA
Specific energy by pole	W/R	40 kJ/ohm	40 kJ/ohm	40 kJ/ohm	40 kJ/ohm
Protection level @ In (8/20 μs)	Up	1.7 kV	1.6 kV	1.3 kV	0.9 kV
Residual voltage @ 5kA (8/20 μs)	Up-5kA	1.5 kV	1.2 kV	1 kV	0.6 kV
Admissible short-circuit current	Iscsr	50 000 A	50 000 A	50 000 A	50 000 A

Associated disconnectors	
Thermal disconnector	internal
Fuses	125 A min. - 315 A max. - gG type / or CITEL SFD-13
Existing upstream ground fault breaker (if any)	Type "S" or delayed
Mechanical characteristics	
Dimensions	see diagram, 1TE, DIN 43880
Connection to Network	By screw terminals: 2.5-25 mm ² (35mm ² rigid)
Failsafe mode	Disconnection from AC network
Disconnection indicator	1 mechanical indicator Green/Red
Remote signaling of disconnection output on changeover contact	option option Option option
Max. voltage/current for remote signaling	DAC1-13S-10-440 DAC1-13S-10-320 DAC1-13S-10-275 DAC1-13S-10-150
Wiring for remote signaling	250 V/0.5 A (AC) / 30 V/3 A (DC)
Wiring for remote signaling	max 1.5 mm ²
Mounting	Symmetrical rail 35 mm (EN60715)
Operating temperature	-40/+85°C
Protection rating	IP20
Housing material	Thermoplastic UL94 V-0
Spare unit	MDAC1-13-440 MDAC1-13-320 MDAC1-13-275 MDAC1-13-150
Standards	
Certification	EAC KEMA / EAC KEMA / EAC KEMA / EAC
Compliance	IEC 61643-11 / NF EN 61643-11 / UL1449 ed.4
Part number	
	821710411 821710311 821710211 821710111

TYPE 1 + 2 AC MULTIPOLAR SURGE PROTECTOR

DAC1-13-11, DAC1-13-20, DAC1-13-30, DAC1-13-31, DAC1-13-40



DAC1-13S-20

DAC1-13S-xx-xxx

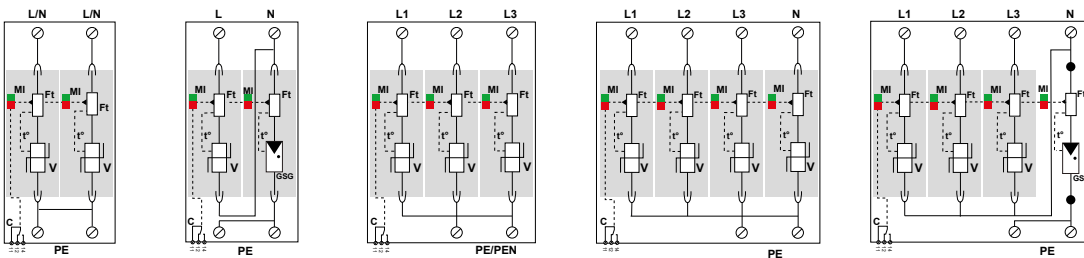
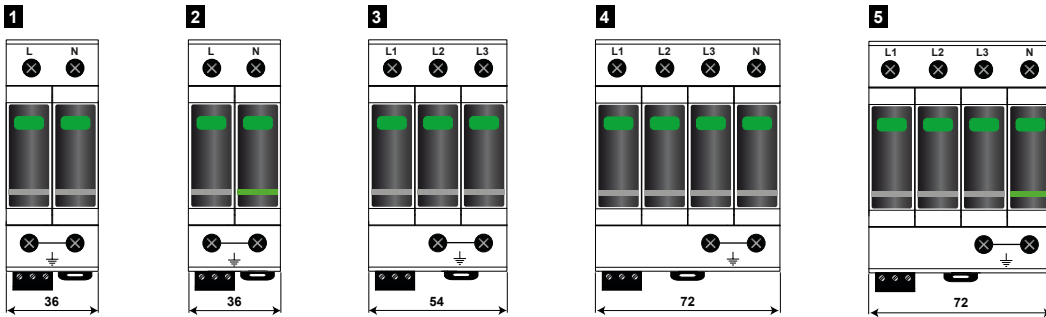
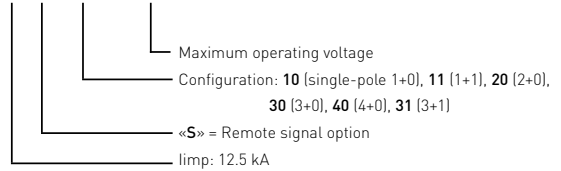

V: High energy MOV
GSG: Specific gas tube
Mi: Disconnection indicator
Ft: Thermal fuse
t°: Thermal disconnection mechanism
C: Contact for remote signal

Model	P/N	Network	AC system	Protection Mode	I _{total}	Up L/PE	Up L/N	Up N/PE	Dimension DIN43880	Diagram
DAC1-13-31-320	821710334	230/400 V 3-Phase+N	TT-TNS System (3+1)	L/N and N/PE	50 kA	-	1.6 kV	1.5 kV	4 TE	5
DAC1-13-31-275	821710234	230/400 V 3-Phase+N	TT-TNS System (3+1)	L/N and N/PE	50 kA	-	1.3 kV	1.5 kV	4 TE	
DAC1-13-31-150	821710134	120/208 V 3-Phase+N	TT-TNS System (3+1)	L/N and N/PE	50 kA	-	0.9 kV	1.5 kV	4 TE	
DAC1-13-40-440	821710414	230/400 V 3-Phase+N	IT System (4+0)	L/PE and N/PE	50 kA	1.7 kV	-	1.7 kV	4 TE	4
DAC1-13-40-320	821710314	230/400 V 3-Phase+N	TNS System (4+0)	L/PE and N/PE	50 kA	1.6 kV	-	1.6 kV	4 TE	
DAC1-13-40-275	821710214	230/400 V 3-Phase+N	TNS System (4+0)	L/PE and N/PE	50 kA	1.3 kV	-	1.3 kV	4 TE	
DAC1-13-40-150	821710114	120/208 V 3-Phase+N	TNS System (4+0)	L/PE and N/PE	50 kA	0.9 kV	-	0.9 kV	4 TE	3
DAC1-13-30-440	821710413	230/400 V 3-Phase	IT System (3+0)	L/PE	37.5 kA	1.7 kV	-	-	3 TE	
DAC1-13-30-320	821710313	230/400 V 3-Phase	TNC System (3+0)	L/PE	37.5 kA	1.6 kV	-	-	3 TE	
DAC1-13-30-275	821710213	230/400 V 3-Phase	TNC System (3+0)	L/PE	37.5 kA	1.3 kV	-	-	3 TE	1
DAC1-13-30-150	821710113	120/208 V 3-Phase	TNC System (3+0)	L/PE	37.5 kA	0.9 kV	-	-	3 TE	
DAC1-13-11-320	821710332	230 V single phase	TT-TN System (1+1)	L/N and N/PE	25 kA	-	1.6 kV	1.5 kV	2 TE	
DAC1-13-11-275	821710232	230 V single phase	TT-TN System (1+1)	L/N and N/PE	25 kA	-	1.3 kV	1.5 kV	2 TE	2
DAC1-13-11-150	821710132	120 V single phase	TT-TN System (1+1)	L/N and N/PE	25 kA	-	0.9 kV	1.5 kV	2 TE	
DAC1-13-20-440	821710412	230 V single phase	IT System (2+0)	L/PE and N/PE	25 kA	1.7 kV	-	1.7 kV	2 TE	
DAC1-13-20-320	821710312	230 V single phase	TN System(2+0)	L/PE and N/PE	25 kA	1.6 kV	-	1.6 kV	2 TE	1
DAC1-13-20-275	821710212	230 V single phase	TN System(2+0)	L/PE and N/PE	25 kA	1.3 kV	-	1.3 kV	2 TE	
DAC1-13-20-150	821710112	120 V single phase	TN System (2+0)	L/PE and N/PE	25 kA	0.9 kV	-	0.9 kV	2 TE	

TYPE 2 AND TYPE 3 SURGE PROTECTORS

Type 2 (or Type 2+3) Surge Protectors are designed to be installed at the origin of the electrical installation or close to sensitive equipment to protect against transient voltages coupled into the Low Voltage network, if no LPS is used.

Regarding international standard, Type 2 AC Surge Protectors are required for most of the installations, linked with the consequences of possible losses due to the surge voltages. These Surge Protectors are testing following Class II tests from IEC 61643-11, with 8/20 μ s discharge currents.

Type 3 surge protectors are low power SPDs, intended to be installed near sensitive equipment, in coordination with Type 2 SPD installed upstream. Type 3 SPDs are especially required if the sensitive devices to protect are located farther than 10 m away from the Type 2 SPD.

CITEL Type 2 and Type 3 surge protectors are available in a wide range of versions to be adaptable to all configurations :

- I_{max} by pole : from 5 to 70 kA
- Single, 3 or 3-Phase+Neutral AC network
- Compact versions
- 230/400V or 120/208V AC networks
- All AC system types
- Remote signaling option
- Integrated fuse option : SPDI (DACF25 / DACF15)
- Common mode protection (CT1 configuration) or Common and Differential mode protection (CT2 configuration)





CITEL Type 2 and Type 3 surge protectors are offered mainly in pluggable version. Monobloc solutions are also available.







CITEL Type 2 are based on the use of varistors. Type 2+3 «High efficiency» versions are based on VG technology (DAC50VG)



STANDARD SURGE PROTECTORS

Range		Description	I _{max} / pole	Characteristics	Page
DAC80		Reinforced Type 2 SPD	80 kA	Type 2 High energy pluggable	49
DAC50VG		Type 2+3 SPD VG Technology	50 kA	Type 2 + 3 Very high efficiency pluggable	51
DAC50		Type 2 SPD	50 kA	Type 2 pluggable	53
DACF25		Type 2 SPD + integrated fuse	25 kA	Type 2 Integrated fuse pluggable	55
DACF15		Type 2 (or 3) SPD+ integrated fuse	15 KA	Type 2 (or 3) Integrated fuse pluggable	59

COMPACT SURGE PROTECTORS

Range		Description	I _{max} /pole	Characteristics	Page
DAC40C DAC15C		Single phase SPD	40 kA 15 kA	Single phase Compact Pluggable	57 61
DAC40C DAC15C		3-phase+N SPD	40 kA 15 kA	3-phase Compact Pluggable	58 62
DACN10		Single phase SPD	10 kA	Single phase Compact Monobloc	63
DS40HFS DS-HF		SPD + RFI filter	40kA 10 kA	SPD with RFI filter stage	65 66



DAC80-10

DAC80 SERIES



- Re-inforced Type 2 Surge Protector
- In: 40 kA
- Imax: 80 kA
- Pluggable module by phase
- Remote Signaling option
- IEC 61643-11, EN 61643-11 and UL1449 ed.4 compliance

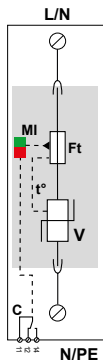
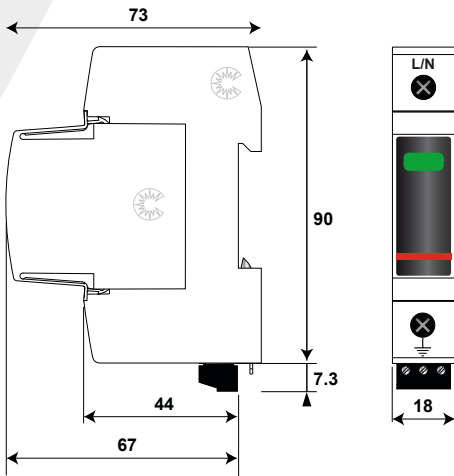

V: High energy varistor
 Ft: Thermal Fuse
 C: Remote signaling contact
 t°: Thermal disconnection system
 MI: Disconnection indicator

Characteristics

CITEL Model		DAC80-10-440	DAC80-10-320	DAC80-10-275	DAC80-10-150
Description		Type 2 AC surge protector - one-pole - pluggable			
Maximum AC operating voltage	Uc	440 Vac	320Vac	275 Vac	150 Vac
Temporary Over Voltage (TOV) Characteristics - 5 sec.	UT	580 Vac withstand	335 Vac withstand	335 Vac withstand	180 Vac withstand
Temporary Over Voltage (TOV) Characteristics -120mn	UT	770 Vac disconnection	440 Vac disconnection	440 Vac disconnection	230 Vac disconnection
Residual current <i>Leakage current at Uc</i>	Ipe	< 1 mA	< 1 mA	< 1 mA	< 1 mA
Follow current	If	None	None	None	None
Nominal discharge current <i>15 x 8/20 μs impulses</i>	In	40 kA	40 kA	40 kA	40 kA
Max. discharge current <i>max. withstand @ 8/20 μs by pole</i>	Imax	80 kA	80 kA	80 kA	80 kA
Protection level @ In [8/20μs]	Up	1.8 kV	1.4 kV	1.2 kV	0.9 kV
Residual voltage @ 5 kA [8/20μs]	Up-5kA	1.4 kV	1 kV	0.9 kV	0.7 kV
Admissible short-circuit current	Iscsr	50 000 A	50 000 A	50 000 A	50 000 A
Associated disconnectors					
Thermal disconnector		internal			
Fuses		50 A min. - 125 A max. - gG Type			
Installation ground fault breaker (if any)		Type "S" or delayed			
Mechanical characteristics					
Dimensions		see diagram - 1TE (DIN43880)			
Connection to Network		By screw terminals: 2.5-25 mm ² (35mm ² rigid)			
Failsafe mode		Disconnection from network			
Disconnection indicator		1 mechanical indicator Green/Red			
Remote signaling of disconnection output on changeover contact		option	option	option	option
Max. voltage/current for remote signaling		DAC80S-10-440	DAC80S-10-320	DAC80S-10-275	DAC80S-10-150
Wiring for remote signaling		250 V/0.5 A (AC) / 30V/3 A (DC)			
Wiring for remote signaling		max. 1.5 mm ²			
Mounting		Symmetrical rail 35 mm (EN60715)			
Operating temperature		-40/+85°C			
Protection rating		IP20			
Housing material		Thermoplastic UL94 V-0			
Spare unit		MDAC80-440	MDAC80-320	MDAC80-275	MDAC80-150
Standards					
Compliance		EN 61643-11 / IEC 61643-11 / UL1449 ed.4			
Part number					
		821210411	821210311	821210211	821210111

HEAVY DUTY TYPE 2 AC MULTIPOLAR SURGE PROTECTOR

DAC80-11, DAC80-20, DAC80-30, DAC80-31, DAC80-40



DAC80-31

DAC80S-xx-xxx

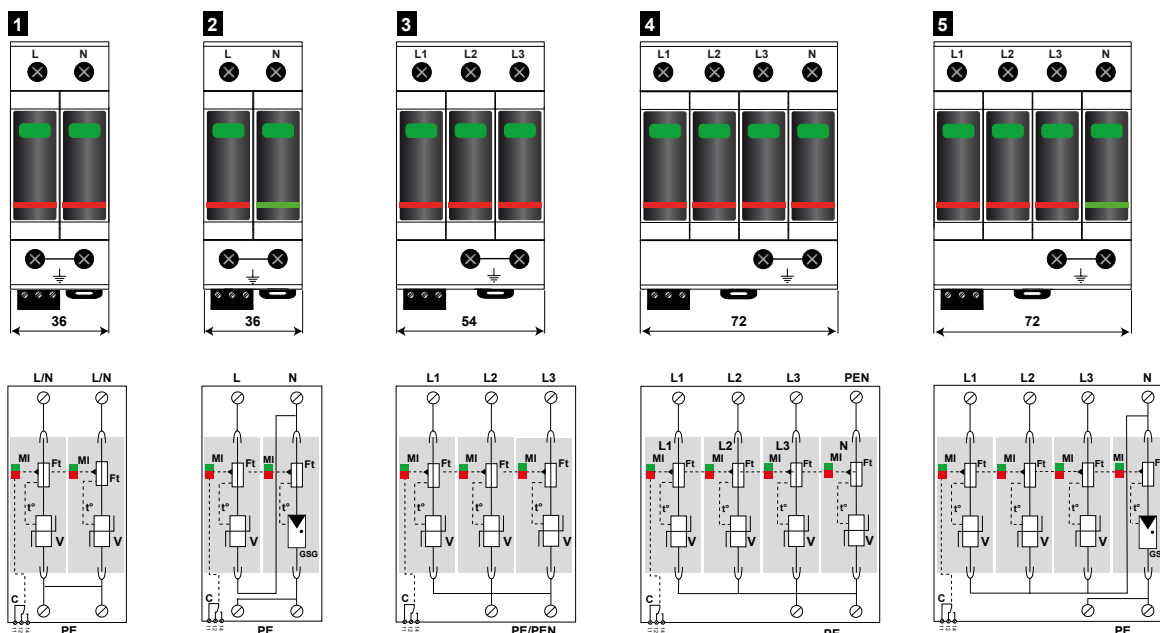
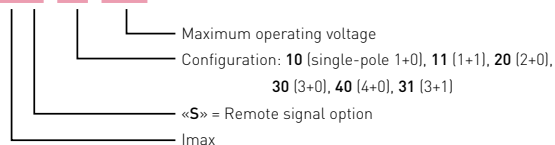

V: High-energy varistor
GSG: Specific gas tube
Ft: Thermal fuse
C: Contact remote signal
t°: Thermal disconnection system
MI: Disconnection indicator

Model	Part number	Network	AC system	Protection Mode	Up L/PE	Up L/N	Up N/PE	Dimensions DIN43880	Diagram
DAC80-31-320	821210334	230/400 V 3-phase+N	TT-TNS system (3+1)	L/N and N/PE	-	1.4 kV	1.5 kV	4 TE	5
DAC80-31-275	821210234	230/400 V 3-phase+N	TT-TNS system (3+1)	L/N and N/PE	-	1.2 kV	1.5 kV	4 TE	
DAC80-31-150	821210134	120/208 V 3-phase+N	TT-TNS system (3+1)	L/N and N/PE	-	0.9 kV	1.5 kV	4 TE	
DAC80-40-440	821210414	230/400 V 3-phase+N	IT system (4+0)	L/PE and N/PE	1.8 kV	-	1.8 kV	4 TE	4
DAC80-40-320	821210314	230/400 V 3-phase+N	TNS system (4+0)	L/PE and N/PE	1.4 kV	-	1.4 kV	4 TE	
DAC80-40-275	821210214	230/400 V 3-phase+N	TNS system (4+0)	L/PE and N/PE	1.2 kV	-	1.2 kV	4 TE	
DAC80-40-150	821210114	120/208 V 3-phase+N	TNS system (4+0)	L/PE and N/PE	0.9 kV	-	0.9 kV	4 TE	3
DAC80-30-440	821210413	230/400 V 3-phase	IT system (3+0)	L/PE	1.8 kV	-	-	3 TE	
DAC80-30-320	821210313	230/400 V 3-phase	TNC system (3+0)	L/PE	1.4 kV	-	-	3 TE	
DAC80-30-275	821210213	230/400 V 3-phase	TNC system (3+0)	L/PE	1.2 kV	-	-	3 TE	1
DAC80-30-150	821210113	120/208 V 3-phase	TNC system (3+0)	L/PE	0.9 kV	-	-	3 TE	
DAC80-11-320	821210332	230 V single phase	TT-TN system(1+1)	L/N and N/PE	-	1.4 kV	1.5 kV	2 TE	
DAC80-11-275	821210232	230 V single phase	TT-TN system(1+1)	L/N and N/PE	-	1.2 kV	1.5 kV	2 TE	2
DAC80-11-150	821210132	120 V single phase	TT-TN system(1+1)	L/N and N/PE	-	0.9 kV	1.5 kV	2 TE	
DAC80-20-440	821210412	230 V single phase	IT system (2+0)	L/PE and N/PE	1.8 kV	-	1.8 kV	2 TE	
DAC80-20-320	821210312	230 V single phase	TN system (2+0)	L/PE and N/PE	1.4 kV	-	1.4 kV	2 TE	1
DAC80-20-275	821210212	230 V single phase	TN system (2+0)	L/PE and N/PE	1.2 kV	-	1.2 kV	2 TE	
DAC80-20-150	821210112	120 V single phase	TN system (2+0)	L/PE and N/PE	0.9 kV	-	0.9 kV	2 TE	



DAC50VGS-10

DAC50VG SERIES



- Type 2+3 AC Surge Protector
- VG Technology
- In: 20 kA
- No leakage current
- Remote signaling (option)
- Optimized to TOV
- IEC 61643-11, EN 61643-11 certified
- UL1449 ed.4 compliance

Characteristics

CITEL Model	DAC50VG-10-320	DAC50VG-10-275	DAC50VG-10-150
Description	Type 2 AC surge protector - 1-pole - pluggable		
Maximum AC operating voltage	Uc 320 Vac	275 Vac	150 Vac
Temporary Over Voltage (TOV) Characteristic - 5 sec.	UT 335 Vac withstand	335 Vac withstand	180 Vac withstand
Temporary Over Voltage (N/PE TOV) Characteristic -120mn	UT 440 Vac withstand	440 Vac withstand	230 Vac withstand
Residual current <i>Leakage current at Uc</i>	Ipe None	None	None
Follow current	If None	None	None
Nominal discharge current <i>5 x 8/20 μs impulses</i>	In 20 kA	20 kA	20 kA
Maximum discharge current <i>max. withstand 8/20μs by pole</i>	Imax 50 kA	50 kA	50 kA
Withstand on combination waveform - <i>Class III test</i>	Uoc 6 kV	6 kV	6 kV
Protection level <i>(@ In (8/20μs) and 6 kV(1,2/50μs)</i>	Up 1.5 kV	1.5 kV	1.5 kV
Residual voltage <i>@ 5 kA (8/20μs)</i>	Up-5kA 0.9 kV	0.7 kV	0.4 kV
Admissible short-circuit current	Iscrr 50 000 A	50 000 A	50 000 A
Associated disconnectors			
Thermal disconnector	internal		
Fuses	50 A min. - 160 A max. - gG Type		
Existing upstream ground fault breaker (if any)	Type "S" or delayed		
Mechanical characteristics			
Dimensions	see diagram - 1 TE (DIN43880)		
Connection to Network	By screw terminals: 2.5-25 mm ² (35mm ² rigid)		
Failsafe mode	Disconnection from AC network		
Disconnection indicator	1 mechanical indicator Green/Red		
Remote signaling of disconnection output on change over contact	option DAC50VGS-10-320	option DAC50VGS-10-275	option DAC50VGS-10-150
Max. voltage/current for remote signaling	250 V/0.5 A (AC) / 30 V/3 A (DC)		
Wiring for remote signaling	max. 1.5 mm ²		
Mounting	Symmetrical rail 35 mm (EN60715)		
Operating temperature	-40/+85°C		
Protection rating	IP20		
Housing material	Thermoplastic UL94 V-0		
Spare unit	MDAC50VG-320	MDAC50VG-275	MDAC50VG-150
Standards			
Certification	KEMA / EAC		
Compliance	EN 61643-11 / IEC 61643-11 / UL1449 ed.4		
Part number			
	821130311	821130211	821130111

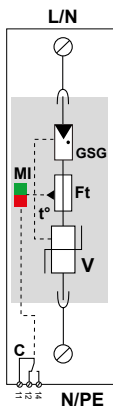
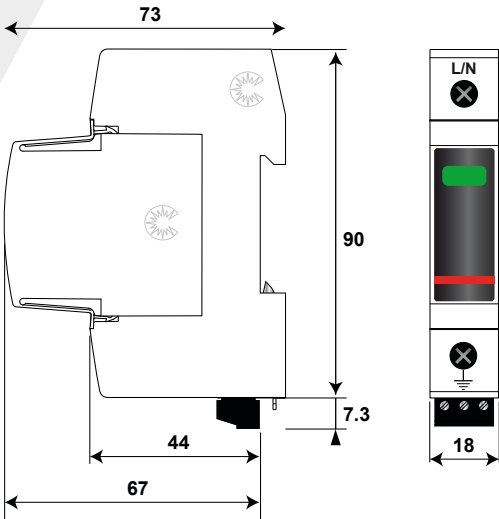

V: High energy varistor
 GSG: Specific Gas Tube
 MI: Disconnection indicator
 Ft: Thermal fuse
 t°: Thermal disconnection system
 C: Contact for remote signal

TYPE 2 + 3 AC MULTIPOLAR SURGE PROTECTOR

DAC50VG-11, DAC50VG-20, DAC50VG-30, DAC50VG-31, DAC50VG-40



DAC50VGS-31

DAC50VGS-xx-xxx

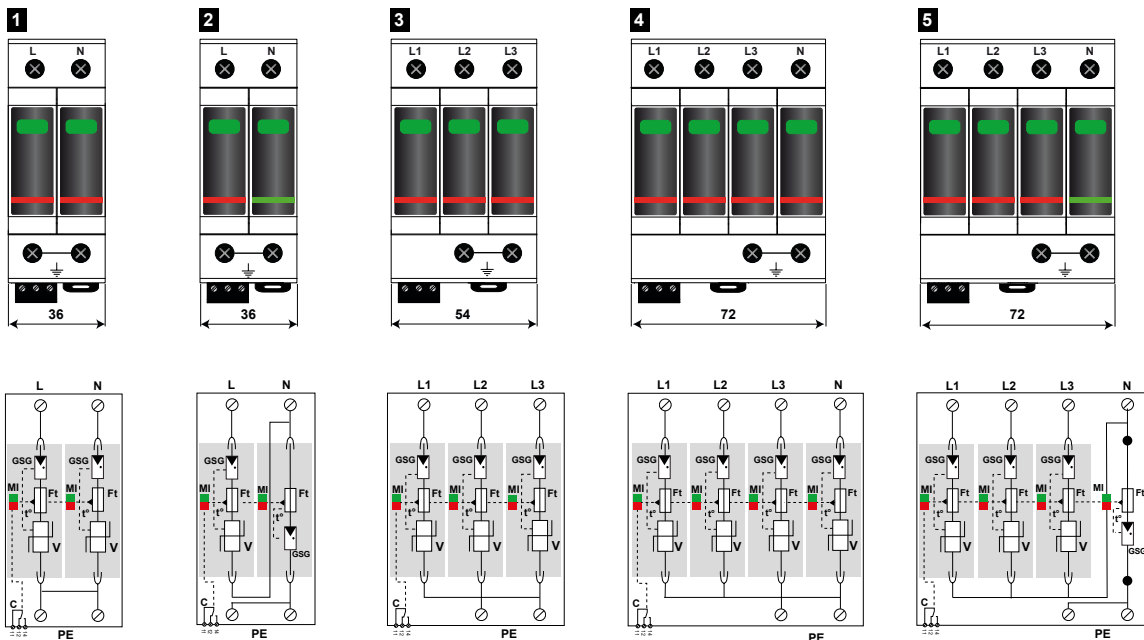
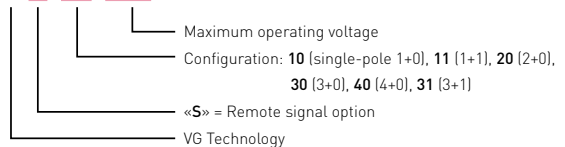

V: High energy varistor
GSG: Specific Gas Tube
MI: Disconnection indicator
Ft: Thermal fuse
t°: Thermal disconnection system
C: Contact for remote signal

Model	P/N	Network	AC system	Protection mode	Up L/PE	Up L/N	Up N/PE	Dimension DIN43880	Diagram
DAC50VG-31-320	821130334	230/400 V 3-Phase+N	TT-TNS System (3+1)	L/N and N/PE	-	1.5 kV	1.5 kV	4 TE	5
DAC50VG-31-275	821130234	230/400 V 3-Phase+N	TT-TNS System (3+1)	L/N and N/PE	-	1.5 kV	1.5 kV	4 TE	
DAC50VG-31-150	821130134	120/208 V 3-Phase+N	TT-TNS System (3+1)	L/N and N/PE	-	1.5 kV	1.5 kV	4 TE	
DAC50VG-40-320	821130314	230/400 V 3-Phase+N	TNS System (4+0)	L/PE and N/PE	1.5 kV	-	1.5 kV	4 TE	4
DAC50VG-40-275	821130214	230/400 V 3-Phase+N	TNS System (4+0)	L/PE and N/PE	1.5 kV	-	1.5 kV	4 TE	
DAC50VG-40-150	821130114	120/208 V 3-Phase+N	TNS System (4+0)	L/PE and N/PE	1.5 kV	-	1.5 kV	4 TE	
DAC50VG-30-320	821130313	230/400 V 3-Phase	TNC System (3+0)	L/PE	1.5 kV	-	-	3 TE	3
DAC50VG-30-275	821130213	230/400 V 3-Phase	TNC System (3+0)	L/PE	1.5 kV	-	-	3 TE	
DAC50VG-30-150	821130113	120/208 V 3-Phase	TNC System (3+0)	L/PE	1.5 kV	-	-	3 TE	
DAC50VG-11-320	821130332	230 V Single Phase	TT-TN System (1+1)	L/N and N/PE	-	1.5 kV	1.5 kV	2 TE	2
DAC50VG-11-275	821130232	230 V Single Phase	TT-TN System (1+1)	L/N and N/PE	-	1.5 kV	1.5 kV	2 TE	
DAC50VG-11-150	821130132	120 V Single Phase	TT-TN System (1+1)	L/N and N/PE	-	1.5 kV	1.5 kV	2 TE	
DAC50VG-20-320	821130312	230 V Single Phase	TN System (2+0)	L/PE and N/PE	1.5 kV	-	1.5 kV	2 TE	1
DAC50VG-20-275	821130212	230 V Single Phase	TN System (2+0)	L/PE and N/PE	1.5 kV	-	1.5 kV	2 TE	
DAC50VG-20-150	821130112	120 V Single Phase	TN System (2+0)	L/PE and N/PE	1.5 kV	-	1.5 kV	2 TE	



DAC50S-10

DAC50 SERIES

- Type 2 AC Surge Protector
- In: 20 kA
- I_{max}: 50 kA
- Pluggable module for each phase
- Remote signaling (option)
- IEC 61643-11, EN 61643-11 certified
- UL type 4CA certified



Characteristics

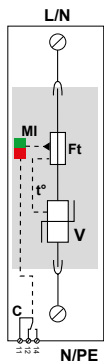
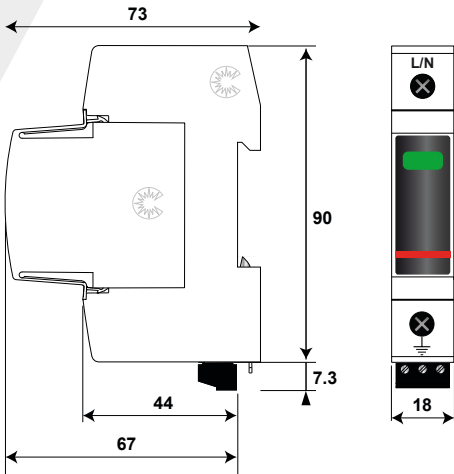

V: High-energy varistor
 Ft: Thermal fuse
 C: Contact for remote signal
 t°: Thermal disconnection system
 Mi : Disconnection indicator

CITEL Model		DAC50-10-760	DAC50-10-440	DAC50-10-275	DAC50-10-150
Description		Type 2 AC surge protector - one-pole - pluggable			
Maximum AC operating voltage	Uc	760 Vac	440 Vac	275 Vac	150 Vac
Temporary Over Voltage (TOV) Characteristics - 5 sec.	UT	1000 Vac withstand	580 Vac withstand	335 Vac withstand	180 Vac withstand
Temporary Over Voltage (TOV) Characteristics - 120mn	UT	1325 Vac disconnection	770 Vac disconnection	440 Vac disconnection	230 Vac disconnection
Residual current <i>Leakage current at Uc</i>	I _{pe}	< 1 mA	< 1 mA	< 1 mA	< 1 mA
Follow current	I _f	None	None	None	None
Nominal discharge current <i>15 x 8/20 μs impulses</i>	I _n	20 kA	20 kA	20 kA	20 kA
Max. discharge current <i>max. withstand @ 8/20 μs by pole</i>	I _{max}	50 kA	50 kA	50 kA	50 kA
Protection level @ I _n (8/20μs)	U _p	2.9 kV	2 kV	1.25 kV	0.9 kV
Residual voltage @ 5 kA (8/20μs)	U _{p-5kA}	2.6 kV	1.5 kV	1 kV	0.6 kV
Admissible short-circuit current	I _{sc}	50 000 A	50 000 A	50 000 A	50 000 A

Associated disconnectors	
Thermal disconnector	internal
Fuses	50 A min. - 125 A max. - gG Type
Installation ground fault breaker (if any)	Type "S" or delayed

Mechanical characteristics	
Dimensions	see diagram - 1TE (DIN43880)
Connection to Network	By screw terminals: 2.5-25 mm ² (35mm ² rigid)
Failsafe mode	Disconnection from network
Disconnection indicator	1 mechanical indicator Green/Red
Remote signaling of disconnection output on changeover contact	option option option option
Max. voltage/current for remote signaling	250 V/0.5 A (AC) / 30V/3 A (DC)
Wiring for remote signaling	max. 1.5 mm ²
Mounting	Symmetrical rail 35 mm (EN60715)
Operating temperature	-40/+85°C
Protection rating	IP20
Housing material	Thermoplastic UL94 V-0
Spare unit	MDAC50-760 MDAC50-440 MDAC50-275 MDAC50-150

Standards	
Certification	OVE / EAC / UL
Compliance	EN 61643-11 / IEC 61643-11 / UL1449 ed.4

Part number	
	821110711 821110411 821110211 821110111

TYPE 2 AC MULTIPOLAR SURGE PROTECTOR

DAC50-11, DAC50-20, DAC50-30, DAC50-31, DAC50-40



DAC50-40

DAC50S-xx-xxx

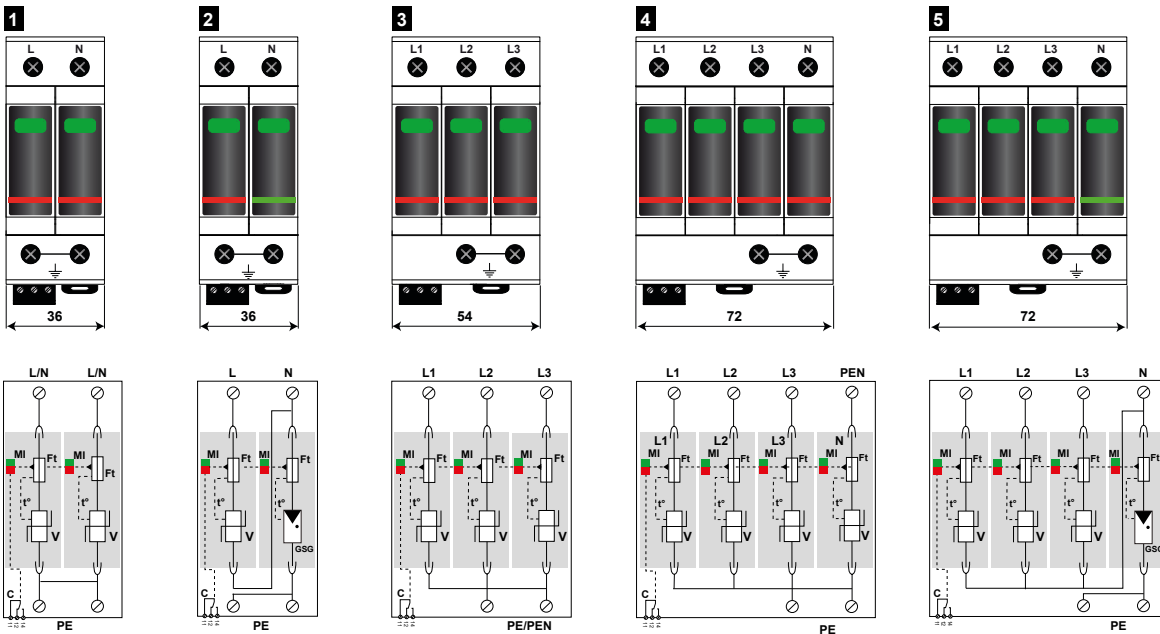
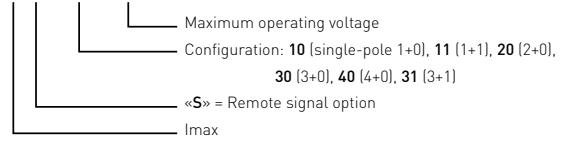

V: High-energy varistor
GSG: Specific gas tube
Ft: Thermal fuse
C: Contact remote signal
t°: Thermal disconnection system
Mi: Disconnection indicator

Model	Part number	Network	AC system	Protection Mode	Up L/PE	Up L/N	Up N/PE	Dimensions DIN43880	Diagram
DAC50-31-275	821110234	230/400 V 3-phase+N	TT-TNS system (3+1)	L/N and N/PE	-	1.25 kV	1.5 kV	4 TE	5
DAC50-31-150	821110134	120/208 V 3-phase+N	TT-TNS system (3+1)	L/N and N/PE	-	0.9 kV	1.5 kV	4 TE	
DAC50-40-440	821110414	230/400 V 3-phase+N	IT system (4+0)	L/PE and N/PE	2 kV	-	2 kV	4 TE	4
DAC50-40-275	821110214	230/400 V 3-phase+N	TNS system (4+0)	L/PE and N/PE	1.25 kV	-	1.25 kV	4 TE	
DAC50-40-150	821110114	120/208 V 3-phase+N	TNS system (4+0)	L/PE and N/PE	0.9 kV	-	0.9 kV	4 TE	3
DAC50-30-760	821110713	690 V 3-phase	TNC system (3+0)	L/PE	2.9 kV	-	-	3 TE	
DAC50-30-440	821110413	230/400 V 3-phase	IT system (3+0)	L/PE	2 kV	-	-	3 TE	
DAC50-30-275	821110213	230/400 V 3-phase	TNC system (3+0)	L/PE	1.25 kV	-	-	3 TE	1
DAC50-30-150	821110113	120/208 V 3-phase	TNC system (3+0)	L/PE	0.9 kV	-	-	3 TE	
DAC50-11-275	821110232	230 V single phase	TT-TN system(1+1)	L/N and N/PE	-	1.25 kV	1.5 kV	2 TE	2
DAC50-11-150	821110132	120 V single phase	TT-TN system(1+1)	L/N and N/PE	-	0.9 kV	1.5 kV	2 TE	
DAC50-20-440	821110412	230 V single phase	IT system (2+0)	L/PE and N/PE	2 kV	-	2 kV	2 TE	1
DAC50-20-275	821110212	230 V single phase	TN system (2+0)	L/PE and N/PE	1.25 kV	-	1.25 kV	2 TE	
DAC50-20-150	821110112	120 V single phase	TN system (2+0)	L/PE and N/PE	0.9 kV	-	0.9 kV	2 TE	

TYPE 2 AC SURGE PROTECTOR WITH INTEGRATED FUSE



DACF25-10

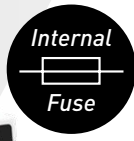

DACF25 SERIES



- Type 2 Surge Protector with integrated fuse (SPDI)
- No external fuse required
- In: 15 kA
- I_{max}: 25 kA
- Pluggable module for each phase
- Remote signaling (option)
- IEC 61643-11 and EN 61643-11 certified
- UL1449 ed.4 compliance

Characteristics

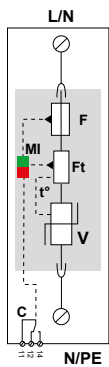
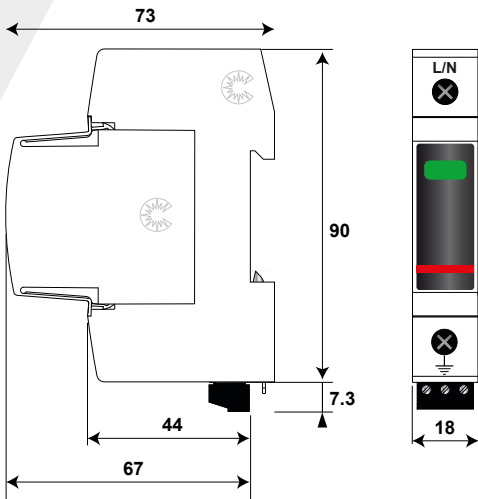

V : Varistor
 F : Fuse
 Ft : Thermal fuse
 C : Contact for remote signal
 t° : Thermal disconnection system
 MI : Disconnection indicator

CITEL Model		DACF25-10-440	DACF25-10-320	DACF25-10-275	DACF25-10-150
Description		Type 2 AC SPD with integrated fuse (SPDI) - 1-pole - pluggable			
Max. AC operating voltage	Uc	440 Vac	320 Vac	275 Vac	150 Vac
Temporary Over Voltage (TOV) Characteristics - 5 sec.	UT	580 Vac withstand	335 Vac withstand	335 Vac withstand	180 Vac withstand
Temporary Over Voltage (TOV) Characteristics - 120 mn	UT	770 Vac disconnection	440 Vac disconnection	440 Vac disconnection	230 Vac disconnection
Residual current Leakage current at Uc	I _{pe}	< 1 mA	< 1 mA	< 1 mA	< 1 mA
Follow current	I _f	None	None	None	None
Nominal discharge current 15 x 8/20 μs impulses	I _n	15 kA	15 kA	15 kA	15 kA
Max. discharge current max. withstand @ 8/20 μs by pole	I _{max}	25 kA	25 kA	25 kA	25 kA
Protection level @ I _n (8/20 μs)	U _p	2 kV	1.5 kV	1.25 kV	0.9 kV
Residual voltage @ 5 kA (8/20 μs)	U _{p-5kA}	1.5 kV	1.2 kV	1 kV	0.6 kV
Admissible short-circuit current	I _{sc}	100 000 A	100 000 A	100 000 A	100 000 A

Associated disconnectors

Thermal disconnector	internal
Fuses	internal (equivalent AC rating : 40 A, gG Type)
Existing upstream ground fault breaker (if any)	Type "S" or delayed

Mechanical characteristics

Dimensions	see diagram, 1 TE (DIN43880)
Connection to Network	By screw terminals: 2.5-25 mm ² (35mm ² rigid)
Failsafe mode	Disconnection from network
Disconnection indicator	1 mechanical indicator Green/Red
Remote signaling of disconnection output on changeover contact	option option option option
Max. voltage/current for remote signaling	DACF25S-10-440 DACF25S-10-320 DACF25S-10-275 DACF25S-10-150
Wiring for remote signaling	250 V/0.5 A (AC) / 30 V/3 A (DC)
Wiring for remote signaling	max. 1.5 mm ²
Mounting	Symmetrical rail 35 mm (EN60715)
Operating temperature	-40/+85°C
Protection rating	IP20
Housing material	Thermoplastic UL94 V-0
Spare unit	MDACF25-440 MDACF25-320 MDACF25-275 MDACF25-150

Standards

Certification	EAC	EAC	KEMA / EAC	EAC
Compliance	IEC 61643-11 / NF EN 61643-11 / UL1449 ed.4			

Part number

	821410411	821410311	821410211	821410111
--	-----------	-----------	-----------	-----------

*] SPDI : SPD including all its safety devices : thermal disconnector AND electrical fuse against short circuit currents.

TYPE 2 AC MULTIPOLAR SURGE PROTECTOR WITH INTEGRATED FUSE

DACF25-11, DACF25-20, DACF25-30
DACF25-31, DACF25-40



DACF25-31

DACF25S-xx-xxx

- Maximum Operating voltage
- Configuration : 10 [single-pole 1+0], 11 [1+1], 20 [2+0], 30 [3+0], 40 [4+0], 31 [3+1]
- «S» = Remote signal option
- I_{max} : 25 kA
- Integrated overcurrent protection (fuse)

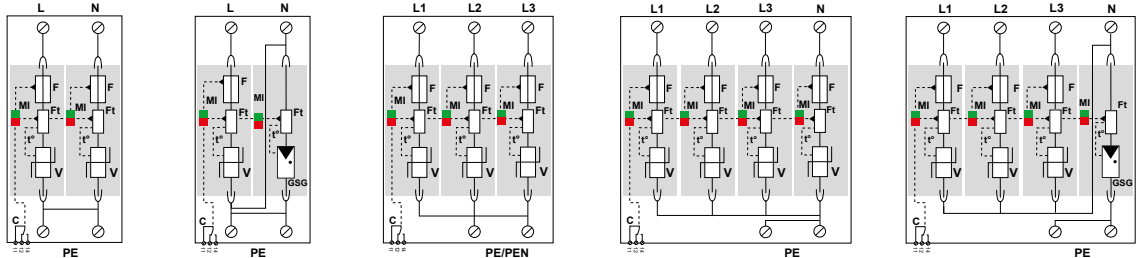
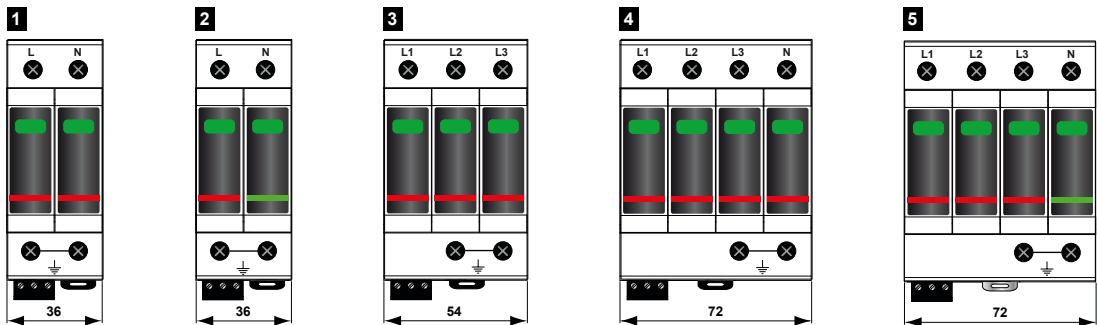

V : Varistor high energy
GSG: Specific gas tube
F: Fuse
Ft: Thermal fuse
C : Contact for remote signal
MI : Disconnection indicator

Model	P/N	Network	AC system	Protection mode	Up L/PE	Up L/N	Up N/PE	Dimension DIN43880	Diagram
DACF25-31-320	821410334	230/400 V 3-Phase+N	TT-TNS System (3+1)	L/N and N/PE	-	1.5 kV	1.5 kV	4 TE	5
DACF25-31-275	821410234	230/400 V 3-Phase+N	TT-TNS System (3+1)	L/N and N/PE	-	1.25 kV	1.5 kV	4 TE	
DACF25-31-150	821410134	120/208 V 3-Phase+N	TT-TNS System (3+1)	L/N and N/PE	-	0.9 kV	1.5 kV	4 TE	4
DACF25-40-440	821410414	230/400 V 3-Phase+N	IT System (4+0)	L/PE and N/PE	2 kV	-	2 kV	4 TE	
DACF25-40-320	821410314	230/400 V 3-Phase+N	TNS System (4+0)	L/PE and N/PE	1.5 kV	-	1.5 kV	4 TE	3
DACF25-40-275	821410214	230/400 V 3-Phase+N	TNS System (4+0)	L/PE and N/PE	1.25 kV	-	1.25 kV	4 TE	
DACF25-40-150	821410114	120/208 V 3-Phase+N	TNS System (4+0)	L/PE and N/PE	0.9 kV	-	0.9 kV	4 TE	
DACF25-30-440	821410413	230/400 V 3-Phase	IT System (3+0)	L/PE	2 kV	-	-	3 TE	2
DACF25-30-320	821410313	230/400 V 3-Phase	TNC System (3+0)	L/PE	1.5 kV	-	-	3 TE	
DACF25-30-275	821410213	230/400 V 3-Phase	TNC System (3+0)	L/PE	1.25 kV	-	-	3 TE	
DACF25-30-150	821410113	120/208 V 3-Phase	TNC System (3+0)	L/PE	0.9 kV	-	-	3 TE	1
DACF25-11-320	821410332	230 V Single Phase	TT-TN System (1+1)	L/N and N/PE	-	1.5 kV	1.5 kV	2 TE	
DACF25-11-275	821410232	230 V Single Phase	TT-TN System (1+1)	L/N and N/PE	-	1.25 kV	1.5 kV	2 TE	
DACF25-11-150	821410132	120 V Single Phase	TT-TN System (1+1)	L/N and N/PE	-	0.9 kV	1.5 kV	2 TE	
DACF25-20-440	821410412	230 V Single Phase	IT System (2+0)	L/PE and N/PE	2 kV	-	2 kV	2 TE	
DACF25-20-320	821410312	230 V Single Phase	TN System (2+0)	L/PE and N/PE	1.5 kV	-	1.5 kV	2 TE	
DACF25-20-275	821410212	230 V Single Phase	TN System (2+0)	L/PE and N/PE	1.25 kV	-	1.25 kV	2 TE	
DACF25-20-150	821410112	120 V Single Phase	TN System (2+0)	L/PE and N/PE	0.9 kV	-	0.9 kV	2 TE	



DAC40C-11

DAC40C SERIES

- Compact single phase Type 2 surge protector
- Common/Differential mode
- Remote signaling contact (option)
- EN 61643-11, IEC 61643-11 certified
- UL1449 ed.4 compliance



DAC40CS-xx-xxx

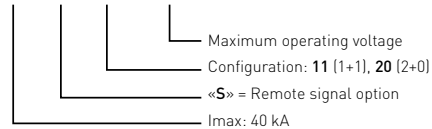

Characteristics

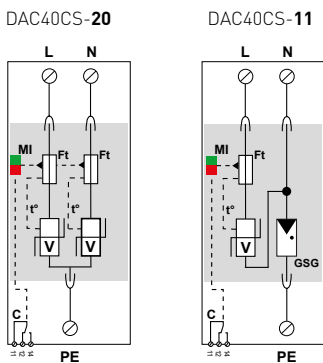
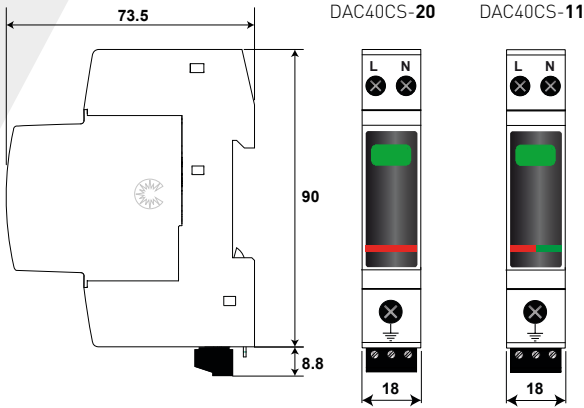

V : High energy varistor
 Ft : Thermal fuse
 C : Contact for remote signal
 t° : Thermal disconnection system
 GSG: Specific gas tube
 MI : Disconnection indicator

CITEL Model		DAC40C-20-440	DAC40C-11-275	DAC40C-11-150
Description		Compact 1-phase Type 2 surge protector - Pluggable		
Network		230 V single-phase		
Protection mode		L/PE and N/PE	L/N and N/PE	L/N and N/PE
AC system		IT	TT-TN	TT-TN
Max. AC operating voltage	Uc	440 Vac	275 Vac	150 Vac
Temporary Over Voltage (TOV)	UT	580 Vac	335 Vac	180 Vac
Characteristic - 5 sec.		withstand	withstand	withstand
Temporary Over Voltage (TOV)	UT	770 Vac	440 Vac	230 Vac
Characteristic - 120mn		disconnection	disconnection	disconnection
Temporary Over Voltage N/PE (TOV HT)	UT	-	1200 V/300A/200 ms withstand	1200 V/300A/200 ms withstand
Residual current - Leakage current at Uc	Ipe	< 1 mA	None	None
Follow current	If	None	None	None
Nominal discharge current 15 x 8/20 μs impulses	In	20 kA	20 kA	20 kA
Max. discharge current max. withstand @ 8/20 μs by pole	Imax	40 kA	40 kA	40 kA
Total discharge current - @8/20μs	Itotal	80 kA	40 kA	40 kA
Protection level @In (8/20μs)	Up L/N	-	1.25 kV	0.9 kV
	Up N/PE	1.8 kV	1.5 kV	1.5 kV
	Up L/PE	1.8 kV	-	-
Admissible short-circuit current	Iscrr	10 000 A	10 000 A	10 000 A

Associated disconnectors

Thermal disconnector	internal
Fuses	50 A min. - 125 A max. - Type gG
Existing upstream ground fault breaker (if any)	Type "S" or delayed

Mechanical characteristics

Dimensions	see diagram, 1TE (DIN43880)
Connection to Network	by screw terminals: L/n = 1.5-10mm ² (16 mm ²) / PE = 2.5-25mm ² (35 mm ² rigid)
Failsafe mode	Disconnection from network
Disconnection indicator	1 mechanical indicator Green/Red
Remote signaling of disconnection output on changeover contact	Option DAC40CS-20-440 Option DAC40CS-11-275 Option DAC40CS-11-150
Max. voltage/current for remote signaling	250 V/0.5 A (AC) / 30 V/3 A (DC)
Wiring for remote signaling	Max. 1.5 mm ²
Mounting	Symmetrical rail 35 mm (EN60715)
Operating temperature	-40/+85°C
Protection rating	IP20
Housing material	Thermoplastic UL94 V-0
Spare unit	MDAC40C-20-440 MDAC40C-11-275 MDAC40C-11-150

Standards

Certification	KEMA
Compliance	IEC 61643-11 / NF EN 61643-11 / UL1449 ed.4

Part number

	821510411	821520211	821520111
--	-----------	-----------	-----------



DAC40CS-31

DAC40C SERIES

- Compact 3-phase Type 2
- Common/Differential mode
- Remote signaling contact (option)
- EN 61643-11, IEC 61643-11 certified
- UL1449 ed.4 compliance



DAC40CS-xx-xxx

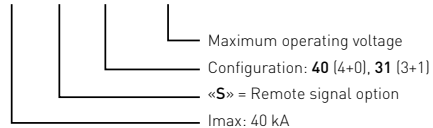

Characteristics

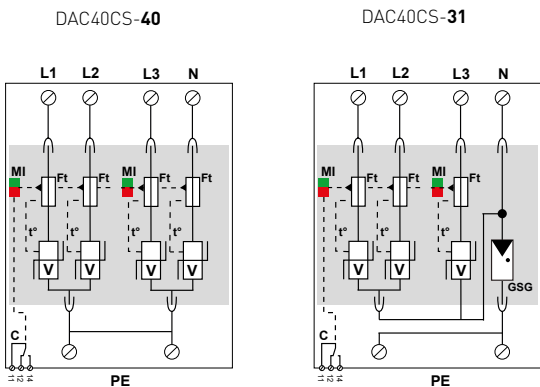
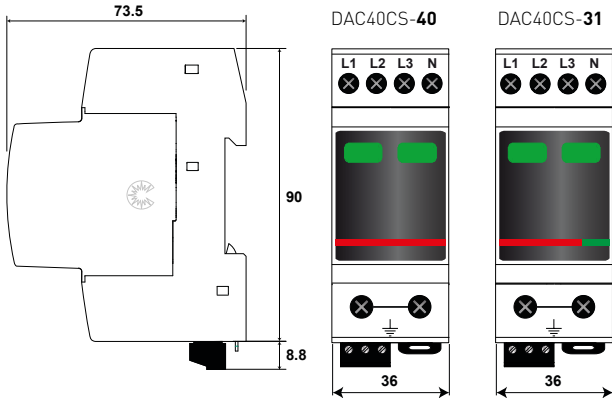

V : High energy varistor
 GSG : Specific GDT
 Ft : Thermal fuse
 C : Contact remote signaling
 t⁹ : Thermal disconnection system
 MI : Disconnection indicator

CITEL Model	DAC40C-40-440	DAC40C-31-275	DAC40C-31-150
Description	Compact 3-phase+N Type 2 surge protector - Pluggable		
Network	230/400 V 3-phase	230/400 V 3-phase	120/208 V 3-phase
Protection mode	L/PE and N/PE	L/N and N/PE	L/N and N/PE
AC system	IT	TT-TN	TT-TN
Max. AC operating voltage	Uc 440 Vac	275 Vac	150 Vac
Temporary Over Voltage (TOV) Characteristic - 5 sec.	UT 580 Vac	335 Vac	180 Vac
Temporary Over Voltage (TOV) Characteristic - 120mn	UT 770 Vac	440 Vac	230 Vac
Temporary Over Voltage N/PE (TOV HT)	UT -	1200 V/300A/200 ms withstand	1200 V/300A/200 ms withstand
Residual current - Leakage current at Uc	Ipe < 1 mA	None	None
Follow current	If None	None	None
Nominal discharge current 15 x 8/20 μs impulses	In 20 kA	20 kA	20 kA
Max. discharge current max. withstand @ 8/20 μs by pole	Imax 40 kA	40 kA	40 kA
Total discharge current @ 8/20 μs	Itotal 160 kA	40 kA	40 kA
Protection level @In (8/20 μs)	Up L/N -	1.25 kV	0.9 kV
	Up N/PE 1.8 kV	1.5 kV	1.5 kV
	Up L/PE 1.8 kV	-	-
Admissible short-circuit current	Iscrr 10000 A	10000 A	10000 A
Associated disconnectors			
Thermal disconnector	internal		
Associated fuses	50 A min. - 125 A max. - Type gG		
Existing upstream ground fault breaker (if any)	Type "S" or delayed		
Mechanical characteristics			
Dimensions	see diagram, 2 TE (DIN43880)		
Connection to Network	by screw terminals: L/N = 1.5-10mm ² [16 mm ²] or PE = 2.5-25mm ² [35 mm ² rigid]		
Failsafe mode	Disconnection from network		
Disconnection indicator	2 mechanical indicators, Green/Red		
Remote signaling of disconnection output on changeover contact	Option DAC40CS-40-440	Option DAC40CS-31-275	Option DAC40CS-31-150
Max. voltage/current for remote signaling	250 V/0.5 A [AC] / 30 V/3 A [DC]		
Wiring for remote signaling	Max. 1.5 mm ²		
Mounting	Symmetrical rail 35 mm (EN60715)		
Operating temperature	-40/+85°C		
Protection rating	IP20		
Housing material	Thermoplastic UL94 V-0		
Spare unit	MDAC40C-40-440	MDAC40C-31-275	MDAC40C-31-150
Standards			
Certification	KEMA		
Compliance	IEC 61643-11 / NF EN 61643-11 / UL1449 ed.4		
Part number			
	821510412	821520212	821520112

TYPE 2 AC SURGE PROTECTOR WITH INTEGRATED FUSE



DACF15-10

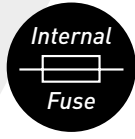

DACF15 SERIES



- Type 2 surge Protector with integrated fuse (SPDI)
- No external fuse required
- In: 5 kA
- I_{max}: 15 kA
- Pluggable module for each phase
- Remote signaling (option)
- IEC 61643-11 and EN 61643-11 compliance
- UL1449 ed.4 compliance

Characteristics

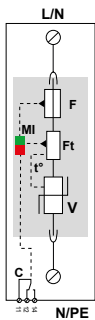
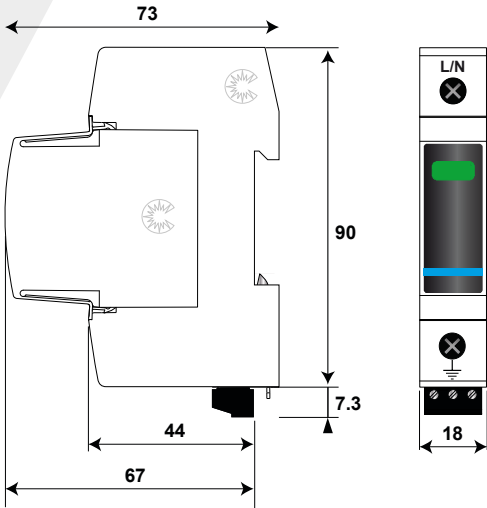

V: Varistor
 F: Fuse
 Ft: Thermal fuse
 C: Contact for remote signal
 t°: Thermal disconnection system
 MI: Disconnection indicator

CITEL Model		DACF15-10-440	DACF15-10-320	DACF15-10-275	DACF15-10-150
Description		Type 2 AC SPD with integrated fuse (SPDI*) - 1-pole - pluggable			
Max. AC operating voltage	Uc	440 Vac	320 Vac	275 Vac	150 Vac
Temporary Over Voltage (TOV) Characteristics - 5 sec.	UT	580 Vac withstand	335 Vac withstand	335 Vac withstand	180 Vac withstand
Temporary Over Voltage (TOV) Characteristics -120 mn	UT	770 Vac disconnection	440 Vac disconnection	440 Vac disconnection	230 Vac disconnection
Residual current Leakage current at Uc	I _{pe}	< 1 mA	< 1 mA	< 1 mA	< 1 mA
Follow current	I _f	None	None	None	None
Nominal discharge current 15 x 8/20 μs impulses	I _n	5 kA	5 kA	5 kA	5 kA
Max. discharge current max. withstand @ 8/20 μs by pole	I _{max}	15 kA	15 kA	15 kA	15 kA
Protection level @ I _n (8/20μs)	U _p	1.5 kV	1.2 kV	1 kV	0.6 kV
Admissible short-circuit current	I _{sc}	100 000 A	100 000 A	100 000 A	100 000 A
Associated disconnectors					
Thermal disconnector		internal			
Fuses		internal (equivalent AC rating : 25 A, gG Type)			
Existing upstream ground fault breaker (if any)		Type "S" or delayed			
Mechanical characteristics					
Dimensions		see diagram, 1 TE (DIN43880)			
Connection to Network		By screw terminals: 2.5-25 mm ² (35mm ² rigid)			
Failsafe mode		Disconnection from network			
Disconnection indicator		1 mechanical indicator Green/Red			
Remote signaling of disconnection output on changeover contact		option	option	option	option
Max. voltage/current for remote signaling		DACF15S-10-440		DACF15S-10-320	DACF15S-10-275
Wiring for remote signaling		max. 1.5 mm ²			
Mounting		Symmetrical rail 35 mm (EN60715)			
Operating temperature		-40/+85°C			
Protection rating		IP20			
Housing material		Thermoplastic UL94 V-0			
Spare unit		MDACF15-440	MDACF15-320	MDACF15-275	MDACF15-150
Standards					
Certification		EAC			
Compliance		IEC 61643-11 / NF EN 61643-11 / UL1449 ed.4			
Part number					
		821310411	821310311	821310211	821310111

*) SPDI :SPD including all its safety devices : thermal disconnector AND electrical fuse against short circuit currents.

TYPE 2 AC MULTIPOLAR SURGE PROTECTOR WITH INTEGRATED FUSE

DACF15-11, DACF15-30, DACF15-31, DACF15-40



DACF15S-31

DACF15S-xx-xxx

- Maximum Operating voltage
- Configuration : **10** [single-pole 1+0], **11** [1+1], **20** [2+0], **30** [3+0], **40** [4+0], **31** [3+1]
- «S» = Remote signal option
- I_{max} : 15 kA
- Integrated overcurrent protection (fuse)

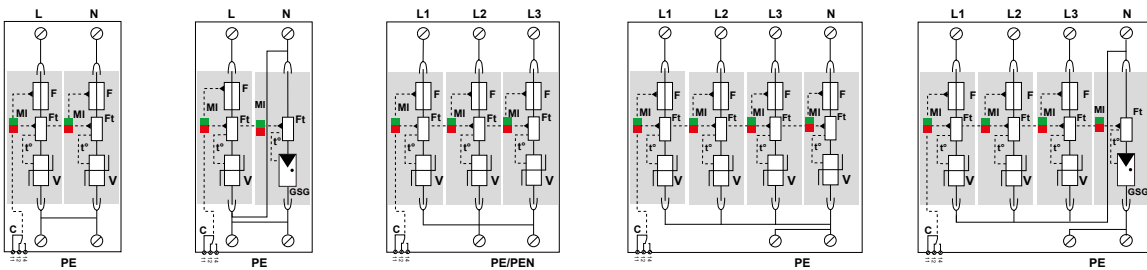
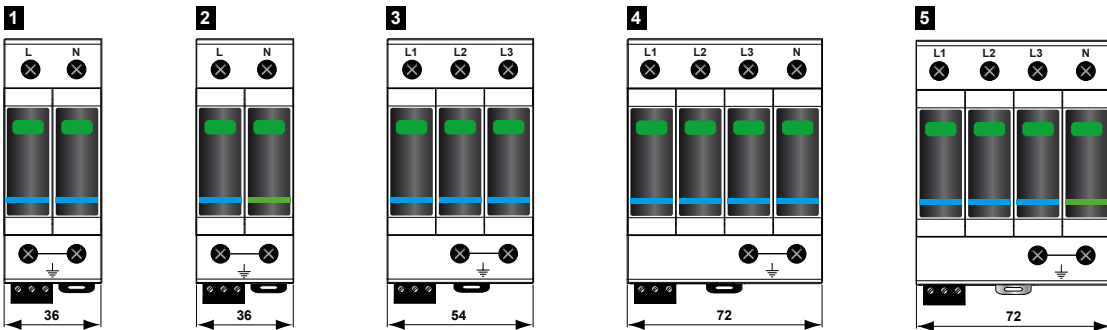

V: Varistor high energy
 GSG: Specific gas tube
 F: Fuse
 Ft: Thermal fuse
 C: Contact for remote signal
 t°: Thermal disconnection system
 MI: Disconnection indicator

Model	P/N	Network	AC system	Protection mode	Up L/PE	Up L/N	Up N/PE	Dimension DIN43880	Diagram
DACF15-31-320	-	230/400 V 3-Phase+N	TT-TNS System (3+1)	L/N and N/PE	-	1.2 kV	1.5 kV	4 TE	5
DACF15-31-275	821310234	230/400 V 3-Phase+N	TT-TNS System (3+1)	L/N and N/PE	-	1 kV	1.5 kV	4 TE	
DACF15-31-150	-	120/208 V 3-Phase+N	TT-TNS System (3+1)	L/N and N/PE	-	0.6 kV	1.5 kV	4 TE	
DACF15-40-440	821310414	230/400 V 3-Phase+N	IT System (4+0)	L/PE and N/PE	1.5 kV	-	1.5 kV	4 TE	4
DACF15-40-320	-	230/400 V 3-Phase+N	TNS System (4+0)	L/PE and N/PE	1.2 kV	-	1.5 kV	4 TE	
DACF15-40-275	-	230/400 V 3-Phase+N	TNS System (4+0)	L/PE and N/PE	1 kV	-	1.5 kV	4 TE	
DACF15-40-150	-	120/208 V 3-Phase+N	TNS System (4+0)	L/PE et N/PE	0.6 kV	-	1.5 kV	4 TE	
DACF15-30-440	821310413	230/400 V 3-Phase	IT System (3+0)	L/PE	1.5 kV	-	-	3 TE	3
DACF15-30-320	-	230/400 V 3-Phase	TNC System (3+0)	L/PE	1.2 kV	-	-	3 TE	
DACF15-30-275	821310213	230/400 V 3-Phase	TNC System (3+0)	L/PE	1 kV	-	-	3 TE	
DACF15-30-150	-	120/208 V 3-Phase	TNC System (3+0)	L/PE	0.6 kV	-	-	3 TE	
DACF15-11-320	-	230 V Single Phase	TT-TN System (1+1)	L/N and N/PE	-	1.2 kV	1.5 kV	2 TE	2
DACF15-11-275	821310232	230 V Single Phase	TT-TN System (1+1)	L/N and N/PE	-	1 kV	1 kV	2 TE	
DACF15-11-150	-	120 V Single Phase	TT-TN System (1+1)	L/N and N/PE	-	0.6 kV	0.6 kV	2 TE	
DACF15-20-440	-	230 V Single Phase	IT System (2+0)	L/PE and N/PE	1.5 kV	-	1.5 kV	2 TE	1
DACF15-20-320	-	230 V Single Phase	TN System (2+0)	L/PE and N/PE	1.2 kV	-	1.5 kV	2 TE	
DACF15-20-275	-	230 V Single Phase	TN System (2+0)	L/PE and N/PE	1 kV	-	1.5 kV	2 TE	
DACF15-20-150	-	120 V Single Phase	TN System (2+0)	L/PE and N/PE	0.9 kV	-	0.9 kV	2 TE	



DAC15C-11

DAC15C SERIES

- Compact single phase Type 2 (or 3)
- Common/Differential mode
- Remote signaling contact (option)
- IEC 61643-11, EN 61643-11 certified
- UL1449 ed.4 compliance



DAC15C**S**-**xx**-**xxx**

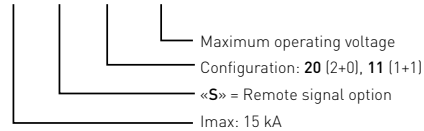

Characteristics

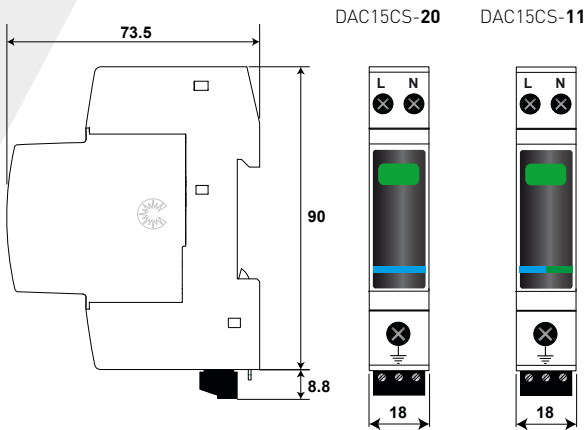

DAC15C-20

DAC15C-11

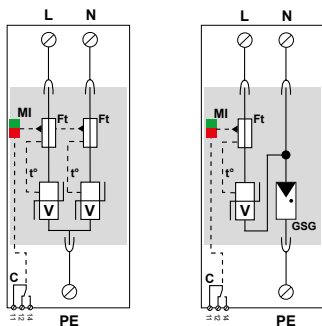

V : High energy varistor
 Ft : Thermal fuse
 C : Contact remote signal
 t° : Thermal disconnection system
 GSG: Specific GDT
 MI : Disconnection indicator

CITEL Model	DAC15C-20-440	DAC15C-11-275	DAC15C-11-150
Description	Compact 1-phase Type 2 surge protector - Pluggable		
Network	230/400 V single-phase	230/400 V single-phase	120/208 V single-phase
Protection mode	L/PE and N/PE	L/N and N/PE	L/N and N/PE
AC system	IT	TT-TN	TT-TN
Max. AC operating voltage	Uc 440 Vac	275 Vac	150 Vac
Temporary Over Voltage (TOV) Characteristic 5 sec.	UT 580 Vac withstand	335 Vac withstand	180 Vac withstand
Temporary Over Voltage (TOV) Characteristic 120 mn	UT 770 Vac disconnection	440 Vac disconnection	230 Vac disconnection
Temporary Over Voltage N/PE (TOV HT)	UT -	1200 V/300A/200 ms withstand	1200 V/300A/200 ms withstand
Residual current - Leakage current at Uc	Ipe < 1 mA	None	None
Follow current	If None	None	None
Nominal discharge current 15 x 8/20 µs impulses	In 5 kA	5 kA	5 kA
Max. discharge current max. withstand @ 8/20 µs by pole	Imax 15 kA	15 kA	15 kA
Total discharge current @ 8/20 µs	Itotal 30 kA	30 kA	30 kA
Withstand on combinaison waveform Class III test	Uoc 10 kV	10 kV	10 kV
Protection level @ In (8/20 µs)	Up L/N -	1 kV	0.6 kV
	Up N/PE 1.5 kV	1.5 kV	1.5kV
	Up L/PE 1.5 kV	-	-
Admissible short-circuit current	Isc cr 10000 A	10000 A	10000 A

Associated disconnectors

Thermal disconnector	internal
Fuses	20 A min - 125 A max. - Type gG
Existing upstream ground fault breaker (if any)	Type "S" or delayed

Mechanical characteristics

Dimensions	see diagram, 1 TE (DIN43880)
Connection to Network	by screw terminals: L/N = 1.5-10 mm ² (16mm ²) or PE = 2.5-25 mm ² (35 mm ² rigid)
Failsafe mode	Disconnection from network
Disconnection indicator	1 mechanical indicators, Green/Red
Remote signaling of disconnection output on changeover contact	Option DAC15C-20-400 Option DAC15C-11-275 Option DAC15C-11-150
Max. voltage/current for remote signaling	250 V/0.5 A (AC) / 30 V/3 A (DC)
Wiring for remote signaling	Max. 1.5 mm ²
Mounting	Symmetrical rail 35 mm (EN60715)
Operating temperature	-40/+85°C
Protection rating	IP20
Housing material	Thermoplastic UL94 V-0
Spare unit	MDAC15C-20-440 MDAC15C-11-275 MDAC15C-11-150

Standards

Certification	KEMA
Compliance	IEC 61643-11 / NF EN 61643-11 / UL1449 ed.4

Part number

821610411	821620211	821620111
-----------	-----------	-----------



DAC15C-40

DAC15C SERIES

- Compact 3-phase Type 2 (or 3)
- Common/Differential mode
- Remote signaling contact (option)
- IEC 61643-11, EN 61643-11 certified
- UL 1449 ed.4 compliance



DAC15CS-xx-xxx

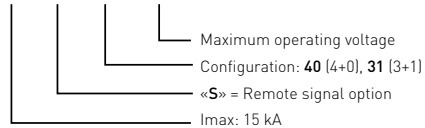

Characteristics

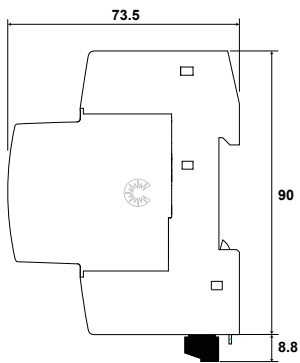

DAC15CS-40



DAC15CS-31

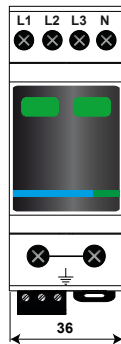

DAC15CS-40

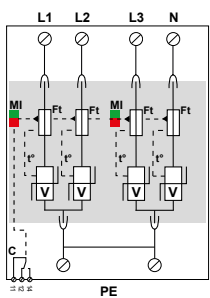

DAC15CS-31

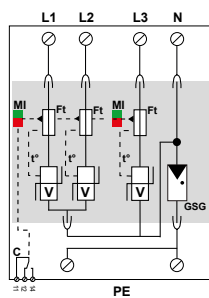

V : High energy varistor
 Ft : Thermal fuse
 C : Contact for remote signal
 t° : Thermal disconnection system
 GSG: Specific GDT
 MI : Disconnection indicator

CITEL Model	DAC15C-40-440	DAC15C-31-275	DAC15C-31-150
Description	Compact 3-phase+N Type 2 surge protector - Pluggable		
Network	230/400 V 3-phase	230/400 V 3-phase	120/208 V 3-phase
Protection mode	L/PE and N/PE	L/N and N/PE	L/N and N/PE
AC system	IT	TT-TN	TT-TN
Max. AC operating voltage	Uc 440 Vac	275 Vac	150 Vac
Temporary Over Voltage (TOV) Characteristic - 5 sec.	UT 580 Vac withstand	335 Vac withstand	180 Vac withstand
Temporary Over Voltage (TOV) Characteristic - 120 mn	UT 770 Vac disconnection	440 Vac disconnection	230 Vac disconnection
Temporary Over Voltage N/PE (TOV HT)	UT -	1200 V/300A/200 ms withstand	1200 V/300A/200 ms withstand
Residual current - Leakage current at Uc	Ipe < 1 mA	None	None
Follow current	If None	None	None
Nominal discharge current 15 x 8/20 µs impulses	In 5 kA	5 kA	5 kA
Max. discharge current max. withstand @ 8/20 µs by pole	Imax 15 kA	15 kA	15 kA
Total discharge current - @ 8/20 µs	Itotal 60 kA	40 kA	40 kA
Withstand on combinaison waveform Class III test	Uoc 10 kV	10 kV	10 kV
Protection level @ In (8/20µs)	Up L/N - Up N/PE 1.5 kV Up L/PE 1.5 kV	0.9 kV 1.5 kV	0.6 kV 1.5kV
Admissible short-circuit current	Isc cr 10000 A	10000 A	10000 A
Associated disconnectors			
Thermal disconnector	internal		
Fuses	20 A min. - 125 A max. - Type gG		
Existing upstream ground fault breaker (if any)	Type "S" or delayed		
Mechanical characteristics			
Dimensions	see diagram, 2 TE (DIN43880)		
Connection to Network	by screw terminals: L/N: 1.5-10mm ² [16mm ²] or PE: 2.5-25mm ² [35mm ² rigid]		
Failsafe mode	Disconnection from network		
Disconnection indicator	2 mechanical indicators, Green/Red		
Remote signaling of disconnection output on changeover contact	Option DAC15CS-40-400	Option DAC15CS-31-275	Option DAC15CS-31-150
Max. voltage/current for remote signaling	250 V/0.5 A (AC) / 30 V/3 A (DC)		
Wiring for remote signaling	Max. 1.5 mm ²		
Mounting	Symmetrical rail 35 mm (EN60715)		
Operating temperature	-40/+85°C		
Protection rating	IP20		
Housing material	Thermoplastic UL94 V-0		
Spare unit	MDAC15C-40-440	MDAC15C-31-275	MDAC15C-31-150
Standards			
Certification	KEMA		
Compliance	IEC 61643-11 / NF EN 61643-11 / UL1449 ed.4		
Part number			
	821610412	821620212	821620112



DACN10 SERIES



- Cost effective Single phase Surge Protector
- Type 2 or Type 3, Monobloc
- 2-port configuration (series mounting)
- In: 5 kA
- Imax: 10 kA
- Load current 25 A
- Remote signaling (option)
- IEC 61643-11 compliance

Characteristics

CITEL Model		DACN10-11-150 DACN10-L11-150	DACN10-11-275 DACN10-L11-275	DACN10-21YG-275 DACN10-L21YG-275	DACN10-20-150	DACN10-20-275	DACN10-20-440
Description		Type 2 or Type 3, 2-port AC single phase surge protector					
Network		120 Vac	230 Vac	230 Vac	120 Vac	230 Vac	230 Vac
Protection mode		L/N and N/PE	L/N and N/PE	L/N and N/PE	L/PE and N/PE	L/PE and N/PE	L/PE and N/PE
AC system		TT-TN	TT-TN	TN	TN	TN	TN-IT
Max. AC operating voltage	Uc	150 Vac	275 Vac	275 Vac	150 Vac	275 Vac	440 Vac
Temporary Over Voltage (TOV) characteristics - 5 sec.	UT	180 Vac withstand	335 Vac withstand	335 Vac withstand	180 Vac withstand	335 Vac withstand	580 Vac withstand
Temporary Over Voltage (TOV) characteristics - 120mn	UT	230 Vac disconnection	440 Vac disconnection	440 Vac disconnection	230 Vac disconnection	230 Vac disconnection	770 Vac disconnection
Temporary Over Voltage N/PE (TOV HT)	UT	1200 V/300A/200 ms withstand	1200 V/300A/200 ms withstand	-	1200 V/300A/200 ms withstand	1200 V/300A/200 ms withstand	-
Residual current <i>Leakage current at Uc</i>	Ipe	none	none	none	< 1 mA	< 1 mA	< 1 mA
Max. Load current	IL	25 A 16 A	25 A 16 A	25 A 16 A	25 A	25 A	25 A
Follow current	If	none	none	none	none	none	none
Nominal discharge current <i>15 x 8/20 μs impulses</i>	In	5 kA	5 kA	5 kA	5 kA	5 kA	5 kA
Max. discharge current <i>max. withstand @ 8/20 μs by pole</i>	Imax	10 kA	10 kA	10 kA	10 kA	10 kA	10 kA
Withstand on Combination waveform - Class III test	Uoc	10 kV	10 kV	10 kV	10 kV	10 kV	10 kV
Protection level @In (8/20μs)	Up L/N Up N/PE Up L/PE	0,7 kV 1,5 kV -	1,1 kV 1,5 kV -	1,3 kV 1,6 kV 1,6 kV	- 0,7 kV 0,7 kV	- 1,1 kV 1,1 kV	- 1,6 kV 1,6 kV
Admissible short-circuit current	Isc cr	10 000 A	10 000 A	10 000 A	10 000 A	10 000 A	10 000 A
Associated disconnectors							
Thermal disconnector		internal					
Fuses		Fuses type gG - 25 A					
Installation ground fault breaker (if any)		Type «S» or delayed					
Mechanical characteristics							
Dimensions		see diagram, 1TE (DIN43880)					
Connection to Network		by screw terminals: 1.5-10 mm ²					
Failsafe behavior		Disconnection SPD (DACN10) - Disconnection SPD + AC line cut off (DACN10L)					
Disconnection indicator		Green LED off					
Remote signaling of disconnection output on NC contact		option DACN10S-11-150 DACN10S-L11-150	option DACN10S-11-275 DACN10S-L11-275	option DACN10S-21YG-275 DACN10S-L21YG-275	option DACN10S-20-150	option DACN10S-20-275	option DACN10S-20-440
Max. voltage/current for remote signaling		250 V/0.5 A (AC) / 30 V/2 A (DC)					
Wiring for remote signaling		Max. 1.5 mm ²					
Mounting		Symmetrical rail 35 mm (EN60715)					
Operating temperature		-40/+85°C					
Protection rating		IP20					
Housing material		Thermoplastic UL94 V-0					
Standards							
Compliance		IEC 61643-11 / EN 61643-11 / UL1449 ed.4					
Part number							
		70111011 70112011	70111021 70112021	70114021 70115021	70113011	70113021	70113031

1-PHASE TYPE 2 (OR 3) AC SURGE PROTECTOR

DACN10S-L xx-xxx

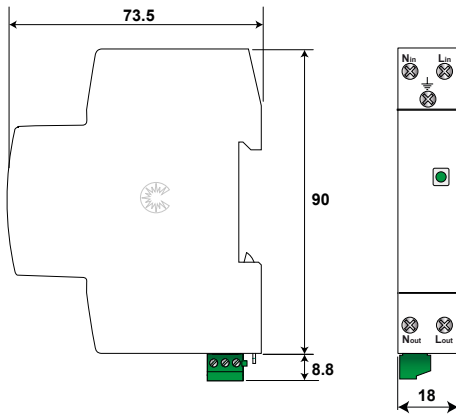
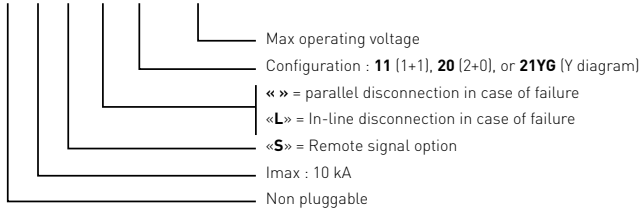

DACN10S-11-xxx

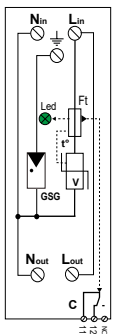

DACN10S-20-xxx

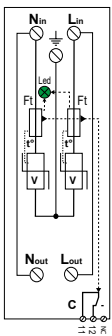

DACN10S-21YG-275

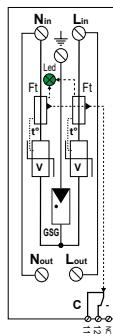

DACN10S-L11-xxx

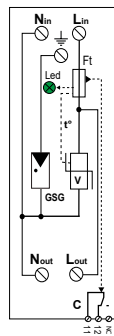

DACN10S-L21YG-275

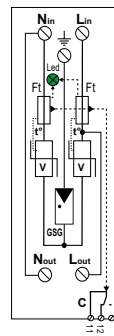

- V: MOV
- GSG: Specific GDT
- F : Thermal fuse
- t[°]: Thermal disconnection mechanism
- LED: Disconnector indicator
- C: Remote signaling contact



DS41HFS-120

DS40HFS SERIES



- Type 2 surge protector
- Integrated RFI Filtering
- In: 20 kA
- I_{max}: 40 kA
- Pluggable module
- Remote signaling
- IEC 61643-11, EN 61643-11, UL1449 ed.4 compliance

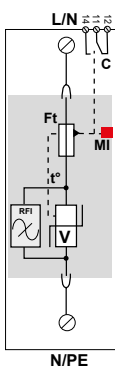
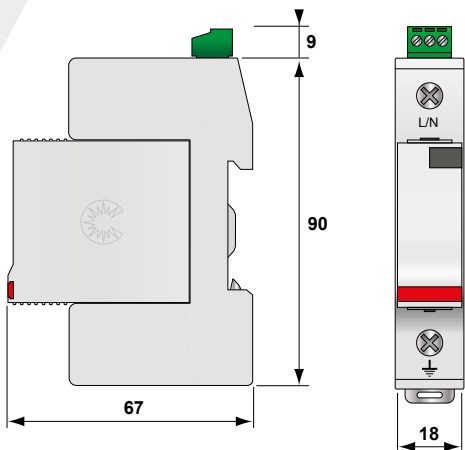

V : MOV
 Ft : Thermal fuse
 t° : Thermal disconnection mechanism
 RFI: RFI filtering
 C: Contact for remote signal
 MI: Disconnection indicator

Characteristics

CITEL Model	DS41HFS-230	DS41HFS-120
Description	Type 2 AC surge protector + RFI filtering	
Network	230/400 V	120/208 V
Connection mode	L/N or N/PE	L/N or N/PE
Max. AC operating voltage	U _c 255 Vac	150 Vac
Temporary Over Voltage (TOV) Characteristics - 5 sec.	UT 335 Vac withstand	180 Vac withstand
Temporary Over Voltage (TOV) Characteristics - 120 mn	UT 440 Vac disconnection	230 Vac disconnection
Residual current - Leakage current at U _c	I _{pe} < 1 mA	< 1 mA
Follow current	I _f None	None
Nominal discharge current <i>15 x 8/20 μs impulses</i>	I _n 20 kA	20 kA
Max. discharge current <i>max. withstand @ 8/20 μs by pole</i>	I _{max} 40 kA	40 kA
Protection level @ In (8/20μs)	U _p 1.25 kV	0.9 kV
Residual voltage @ 5kA (8/20μs)	U _{p-5kA} 1 kV	0.6 kV
Admissible short-circuit current	I _{sc} 25000 A	25000 A
RFI Filtering	0.1-30 Mhz	0.1-30 Mhz
Max. shunt capacitance	0,22 μF	0,22 μF
Associated disconnectors		
Thermal disconnector	internal	
Fuses	Fuses type gG - 50 A	
Installation ground fault breaker (if any)	Type "S" or delayed	
Mechanical characteristics		
Dimensions	see diagram	
Connection to Network	by screw terminals: 2.5-25 mm ²	
Disconnection indicator	1 mechanical indicator	
Remote signaling of disconnection	output on changeover contact	
Mounting	Symmetrical rail 35 mm [EN60715]	
Operating temperature	-40/+85°C	
Protection rating	IP20	
Housing material	Thermoplastic UL94 V-0	
Spare unit	DSM40HF-230	DSM40HF-120
Standards		
Certification	EAC	EAC
Compliance	IEC 61643-11 / EN 61643-11 / UL1449 ed.4	
Part number		
	461590	461690



DS-HF

DS-HF SERIES



- Single phase Surge protector with RFI filtering
- In: 3kA
- Imax: 10 kA
- Common and differential mode protection
- Low protection level
- Operating/disconnection indicators
- IEC 61643-11, EN 61643-11 and UL1449 ed.4 compliance

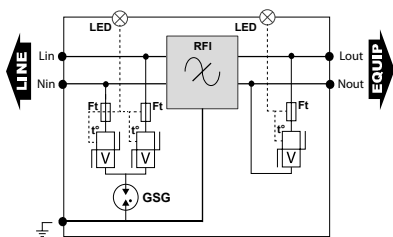
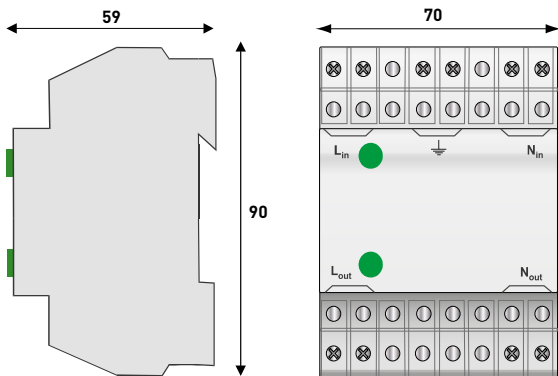

V: Varistor
 GSG: Specific GDT
 Ft: Thermal fuse
 t°: Thermal disconnection system
 LED : Operating indicator
 RFI: RFI filtering

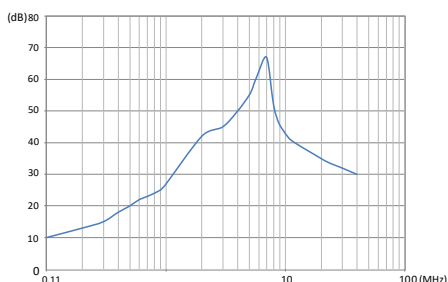

Attenuation curve

Characteristics

CITEL Model	DS-HF	DS-HF-120
Description	Type 2+3 single-phase surge protector and filter	
Network	230 V single phase	120 V single phase
Connection mode	L/N/PE	L/N/PE
AC system	TT-TN	TT-TN
Max. AC operating voltage	Uc 255 Vac	150 Vac
Max. Load current	IL 16 A	16 A
Temporary Over Voltage (TOV) characteristics - 5 sec.	UT 335 Vac withstand	180 Vac withstand
Temporary Over Voltage (TOV) characteristics - 120 mn	UT 440 Vac disconnection	230 Vac disconnection
Residual current - Leakage current at Uc	Ipe < 1 mA	< 1 mA
Follow current	If None	None
Nominal discharge current <i>15 x 8/20 μs impulses</i>	In 3 kA	3 kA
Max. discharge current <i>max. withstand @ 8/20 μs by pole</i>	Imax 10 kA	10 kA
Withstand on Combination waveform - Class III test	Uoc 10 kV	10 kV
Protection level @In [8/20μs]	Up 1 kV/ 0.8 kV	0.6 kV/0.5 kV
Admissible short-circuit current	Iscsr 10000 A	10000 A
RFI Filtering	0.1 - 30 MHz	0.1 - 30 MHz

Associated disconnectors

Thermal disconnector	internal
Fuses	Fuses type gG - 20 A max. (if necessary)
Installation ground fault breaker (if any)	Type "S" or delayed

Mechanical characteristics

Dimensions	see diagram
Connection to Network	by screw terminals: 0.75 - 4 mm ²
Disconnection indicator	Green led(s) off
Remote signaling of disconnection	none
Mounting	Symmetrical rail 35 mm (EN60715)
Operating temperature	-40/+85°C
Protection rating	IP20
Housing material	Thermoplastic UL94 V-0





Standards compliance

Certification	EAC
Compliance	IEC 61643-11 / EN 61643-11 / UL1449 ed.4

Part number

	77945	77948
--	-------	-------

ACCESSORIES FOR AC SURGE PROTECTORS

Model		Description	Page
LSCM-D		Surge Counter & SPD Monitoring	68
DSH		Coordination Inductors	69
SFD		Specific Fuses	70
DSDT16		Screw terminal connection	71

LSCM-D RANGE



Complete unit LSCM-D/24/P1000

- Lightning and Surge Current Counter & SPD monitoring device
- Wide surge current detection range :
 - 0.3/25 kA or 1/50 kA @ 10/350µs
 - 0.3/50 kA or 1/100 kA @ 8/20µs
- Front display for access to recorded events and device parameters
- Peak current and time stamping recording of the surge currents
- RS485 communication interface / MODBUS protocol
- Monitoring features : 2 inputs (SPD or disconnector status)/1 output
- IEC62561-6 compliance

Characteristics

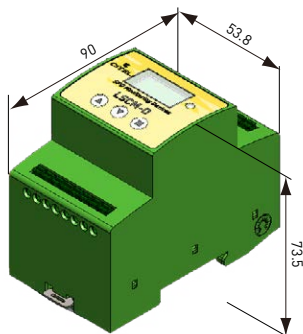

Monitoring unit LSCM-D/24

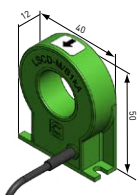

Sensor LSCM-P1000

CITEL Range	LSCM		
Application	Detect and record surge & lightning currents and monitor the SPD status		
Range of lightning current detection	P1000 version: 1-100 kA (8/20µs), 1-50 kA (10/350µs) P300 version: 0.3-50 kA (8/20µs), 0.3-25 kA (10/350µs)		
Input/output	Two channels of input switching signal and one channel of output switching signal		
Communication	RS485 bus (MODBUS protocol)		
Power supply	24 Vdc/ 24 Vac (LSCM-D/24) or 120/230 Vac (LSCM-D/230AC)		
Built-in battery (date saving) life	3-6 months, rechargeable		
Error and precision (peak value)	0.1 kA ; +/- 5%		
Display module	128*64 lattice OLED display, green/red status LED display		
CITEL model	LSCM-D/**	LSCM-P1000	LSCM-P300
Description	Monitoring unit	1 kA sensor	0.3 kA sensor
Dimensions	See diagram	See diagram	see diagram
Weight	130 g	40 g (with 1m wire)	40 g (with 1m wire)
Mounting	Symmetrical DIN rail 35 mm (EN60715)	2*M3 bolts	2*M3 bolts
Operating temperature	-25/+70°C	-25/70°C	-25/+70°C
Storage temperature	-20/+60°C	-20/+60°C	-20/+60°C
Protection rating	IP20	IP20	IP20
Housing material	Thermoplastic UL94 V-0	Thermoplastic UL94 V-0	Thermoplastic UL94 V-0
Connection wire	Not provided	Coaxial cable AWG26	Coaxial cable AWG26
Ground connection	Two connection PE ports	NA	NA
Terminal connection	Spring-cage terminals	Wire connection	Wire connection
Standards			
Compliance	EN 62561-6		
Part number			
LSCM-D/24/P1000	Complete set - 24V power - 1 kA mini detection	793532	
LSCM-D/24/P300	Complete set - 24V power - 0.3 kA mini detection	793531	
LSCM-D/230AC/P1000	Complete set - 230Vac power - 1 kA mini detection	793534	
LSCM-D/230AC/P300	Complete set - 230Vac power - 0.3 kA mini detection	793533	

**) 24 or 230AC

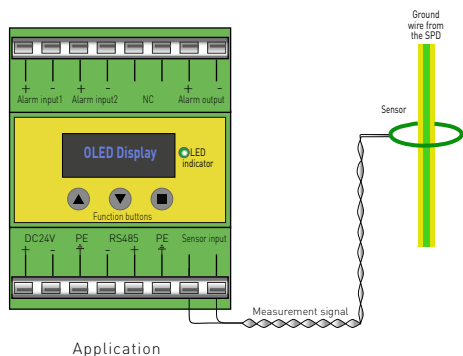

DSH SERIES



DSH 35

- Coordination inductors for Surge Protectors
- For use with the DS series
- 35 A and 63 A versions
- 2x16 A and 2x35 A double inductor versions
- See «coordination» pages 20-21

Characteristics

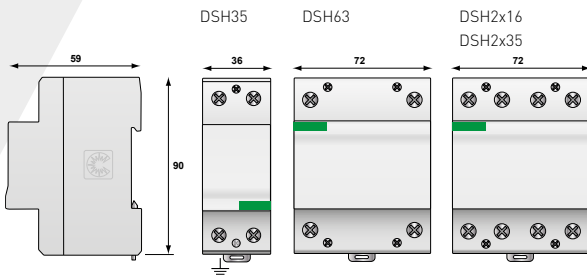

CITEL model	DSH63	DSH35	DSH2x35	DSH2x16
Description	Coordination inductor			
Max. operating voltage	Uc 500 Vac	500 Vac	500 Vac	500 Vac
Max. line current	IL 63 A	35 A	2 x 35 A	2 x 16 A
Line inductance	15 µH	15 µH	2 x 15 µH	2 x 15 µH
Mechanical characteristics				
Wiring	1 DSH in serie on each active wire		1 DSH in series on 2 active wires	
Dimensions	see diagram			
Connection	screw terminals : 6-35 mm ²			
Mounting	Symmetrical DIN rail 35 mm (EN60715)			
Operating temperature	-40/+85°C			
Protection class	IP20			
Housing material	Thermoplastic UL94 V-0			
Part number				
	360807	360806	360808	2690

DSH35

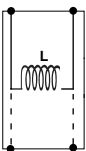

DSH63

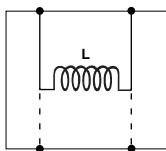

DSH2x16
DSH2x35

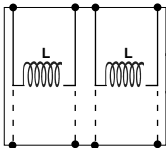

L : inductor

SFD SERIES



- Specific Fuses (SPD Fusing Disconnectors) for short circuit protection of Type 1 AC surge protectors
- Surge current withstand: 12.5 or 25 kA @ 10/350µs
- Very compact
- Fusion signaling feature
- Remote signaling through fuse holder

The SFD range has been especially designed to associated with Type 1 SPDs. These very specific fuses are able to conduct huge surge currents in rather small dimensions to protect Type 1 SPDs against harsh short circuit failures.

In order to comply IEC61643-11 standard, AC power SPD must be protected against short circuit failures : these specific fusing disconnectors must be installed in the SPD branches.

The SFD are equipped with fusing indicator to be used inside dedicated holder with remote signalling feature.

the SFD disconnectors must be used with specific fuse holders which provide :

- Relevant surge current capability
- Remote signaling feature
- Switching (useful for maintenance purpose)

Characteristics

CITEL Model		SFD1-25	SFD1-13
Description		Fusing disconnecter for Type 1 AC surge protector	
Maximum AC operating voltage	Uc	500 Vac	500 Vac
Maximal discharge current	I _{max}	100 kA	80 kA
<i>1 x 8/20 µs impulse</i>			
Nominal discharge current	I _n	80 kA	50 kA
<i>15 x 8/20 µs impulses</i>			
Maximum discharge current	I _{imp}	25 kA	12.5 kA
<i>max. withstand 10/350µs by pole</i>			
Equivalent rated AC current		250 A	125 A
Residual voltage @ I _{imp}	U _p	< 0.5 kV	< 0.4 kV
Breaking capacity		100 000 A	100 000 A
Safety			
Fusing indicator		yes	
Remote fusing indication		through dedicated fuse holder	
Mechanical characteristics			
Format		Cylindrical	Cylindrical
Dimensions		22x58 mm	14x51 mm
Mounting		on cylindrical fuse holder	
Operating temperature		-40/+85°C	
Protection rating		IP20	
Standards			
Compliance		EN 61643-11 / IEC 61643-11 EN 60269-1/EN 60269-2/IEC60269-1/IEC60269-2	
Part number			
		39489	39466



SFD1-25S-31

SFD1-13S-11

ASSEMBLY OF FUSES SFD1-13 (14x51) + HOLDERS

SFD1-13S-11*	64047	Assembly for single phase (L+N) + remote signal
SFD1-13S-20**	64051	Assembly for single phase (L+N) + remote signal
SFD1-13S-30	64052	Assembly for 3-phase + remote signal
SFD1-13S-31*	64048	Assembly for 3-phase+N + remote signal
SFD1-13S-40**	64053	Assembly for 3-phase+N + remote signal

ASSEMBLY OF FUSES SFD1-25 (22x58) + HOLDERS

SFD1-25S-11*	64049	Assembly for single phase (L+N) + remote signal
SFD1-25S-20**	64055	Assembly for single phase (L+N) + remote signal
SFD1-25S-30	64056	Assembly for 3-phase + remote signal
SFD1-25S-31*	64058	Assembly for 3-phase+N + remote signal
SFD1-25S-40**	64057	Assembly for 3-phase+N + remote signal

* the Neutral position is equipped with a non-fusing element, for TT and TN system application

** the Neutral position is equipped with a fusing element, for IT system application

DSDT16



- «V» connection screw terminal for SPD
- Improved connection for better efficiency
- 2 x 35 mm² wire connection

Characteristics

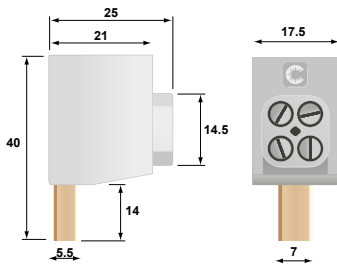

CITEL model	DSDT16
Description	Screw terminal for «V» connection
Mini-max. cross section	2.5 - 35 mm ² (13-2 AWG)
Torque	2-2,2 Nm (18-22 lb-in)
Max Load Current (IL)	100 A
Insulation material	Polycarbonate UL94 V-0
Metal part	Brass
Mounting	on DAC/DS range terminal
Part number	400102

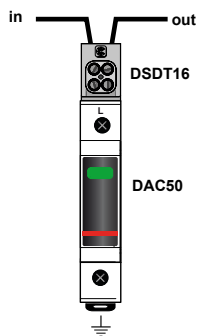



CITEL

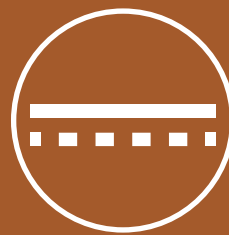
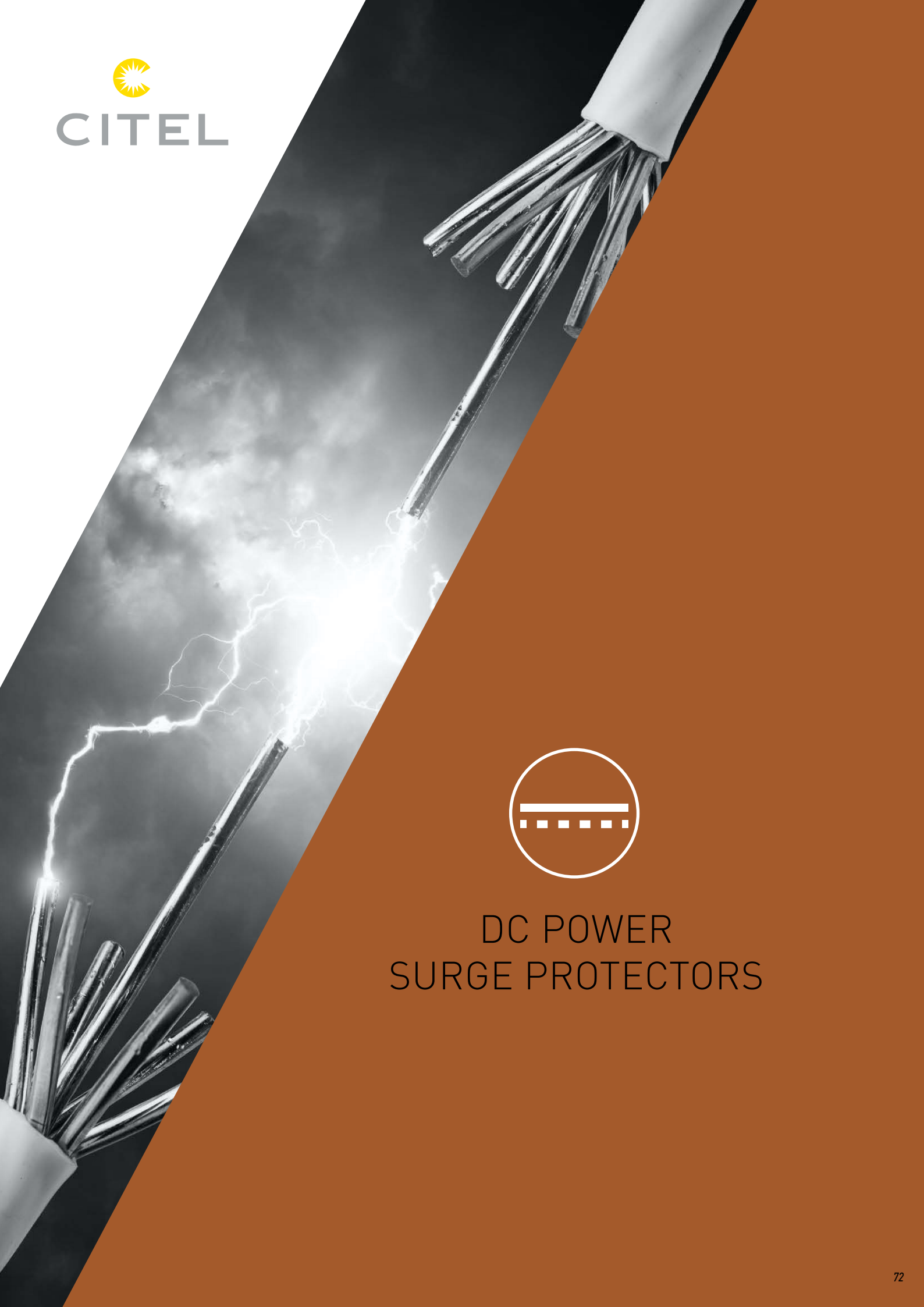

DC POWER SURGE PROTECTORS

DC POWER SURGE PROTECTORS

DC power networks are used in more and more applications and the threat of disturbances due to surge voltages must be taking in to account like for AC power lines.

The most common applications using DC power:

- 48 Vdc for Telecom installations
- 24 to 130 Vdc for off-grid PV sites
- 380/400 Vdc for Datacenters/Telecom centers
- 400 to 1000 Vdc for Electrical Vehicle Charging Stations
- 750 to 1500 Vdc for Railways electrification systems
- 800 to 1500 Vdc for Energy Storage Systems (ESS)

All these installations are critical and their possible disturbances or losses of operations are not acceptable: relevant surge protection will improve their proper operation and life duration.

CITEL has designed a wide range of surge protectors for all the DC power networks.

These surge protectors are available in a wide range of versions to be adaptable to all configurations :

- Type 1 or Type 2 Surge protectors
- DC voltage from 12 to 1500 Vdc
- Pluggable versions
- 1-pole or 2-pole configuration
- «Y» diagram for high voltage application
- Safety disconnectors and remote signaling feature

Selection of DC power Surge protectors

Depending of the type of DC power network, the choice of the relevant SPD must follow these processes

DC power line	Criteria	SPD Selection
Lightning stress	Direct or Indirect	Type 1 or Type 2
Maximum DC voltage	12 to 1200 Vdc	Uc parameter
Topology of the line	1-wire or 2-wire	1-pole or 2-pole configuration
Short circuit current	up to 100 kA	Iscrcr parameter





A particular attention must be paid to the short-circuit condition of the DC power line, which could varies from low rating (controlled DC power source) to huge rating (Battery storage). The related parameter of the SPD (Iscrcr) must be chosen higher than the prospective short circuit current of the DC power line.

Test standard





As the dedicated test standard is not published yet (prIEC61643-41), these DC power SPDs are tested following the existing tests and declare parameters similar to AC power SPDs like Uc (Maximum operating voltage in DC voltage), In (Nominal discharge current), Up (Protection level).



TYPE 1 DC POWER SURGE PROTECTORS

Range		limp/pole	Description	Page
DS252E-420DC		25 kA	Type 1 for 400 Vdc High energy 2-pole	76
DS252C-48DC/G		25 kA	Type 1 for 48 Vdc High energy 2-pole	75
DS250E-48DC		25 kA	Type 1 for 48 Vdc High energy 1-pole	75
DS132RS-420DC		12.5 kA	Type 1 for 400 Vdc Pluggable 1 or 2-pole	76
DS72R-48DC		7 kA	Type 1 for 48 vdc Pluggable 1 or 2-pole	75

TYPE 2 DC POWER SURGE PROTECTORS

Range		I _{max} / pole	Description	Page
DDC50-21Y		50 kA	Pluggable High DC voltage Y diagram	78
DDC30-20		30 kA	Pluggable 1 or 2-pole	77
DDC*C-20		20-30 kA	Pluggable Compact version	79
DS210-DC		2-6 kA	Pluggable Compact version Differential/common mode protection	81
DDCN		3-6 kA	2-port SPD Compact version Differential and common mode protection	83

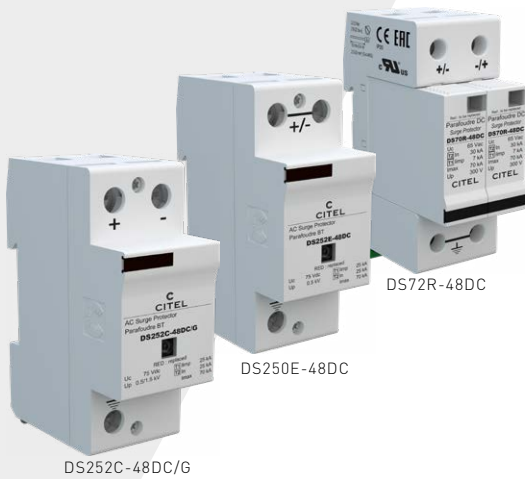

DS25x-48DC DS7x-48DC



- Surge protector for 48 Vdc supplies
- Type 1 and Type 2
- I_{max} up to 70 kA
- I_{limp} up to 25 kA/pole
- Remote signaling (option)
- prIEC 61643-41 and UL1449 ed.4 compliance

Characteristics

CITEL Model	DS252C-48DC/G	DS250E-48DC	DS72R-48DC	DS71R-48DC
Description	2-pole Type 1+2 SPD	1-pole Type 1+2 SPD	2-pole Type 1+2 SPD	1-pole Type 1+2 SPD
Network	48 Vdc	48 Vdc	48 Vdc	48 Vdc
Connection mode	+/- and +/-PE	+PE or -/PE	+PE and -/PE	+PE or -/PE
Protection mode(s)	CM/DM	CM	CM	CM
Max. PV operating voltage	U _c	75 Vdc	65 Vdc	65 Vdc
Residual current <i>Leakage current at U_c</i>	I _{pe}	without	< 0.1 mA	< 0.1 mA
Nominal discharge current <i>15 x 8/20 μs impulses</i>	I _n	25 kA	25 kA	30 kA
Max. discharge current <i>max. withstand @ 8/20 μs by pole</i>	I _{max}	70 kA	70 kA	70 kA
Max. lightning current by pole <i>max. withstand @ 10/350 μs</i>	I _{limp}	25 kA	25 kA	7 kA
Total lightning current <i>max. total withstand @ 8/20 μs</i>	I _{total}	50 kA	-	14 kA
Protection level +/PE (-/PE) <i>@ ln (8/20 μs)</i>	U _p	0.5/1.5 kV	0.5 kV	0.3 kV
Protection level +/- <i>@ ln (8/20 μs)</i>	U _p	0.5 kV	-	-
Associated disconnectors				
Thermal disconnector	internal			
Fuses (if required)	Fuse type gG - 315 A		Fuses type gG - 100 A	
Mechanical characteristics				
Dimensions	see diagram			
Connection to Network	by screw : 6-35 mm ² / by bus		by screw 4-25 mm ²	
Disconnection indicator	1 mechanical indicator		1 mechanical indicator/pole	
Remote signaling of disconnection output on changeover contact	Yes	Yes	option DS72RS-48DC	option DS71RS-48DC
Mounting	Symmetrical rail 35 mm (EN60715)			
Spare unit	-	-	DSM70R-48DC	DSM70R-48DC
Operating temperature	-40/+85°C			
Protection rating	IP20			
Housing material	Thermoplastic UL94-V0			
Standards				
Compliance	prIEC61643-41 / UL1449 ed.4			
Part number				
	3415	63909	492101	322101

DS252C-48DC/G

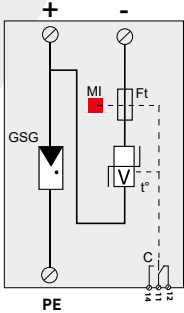

DS250E-48DC

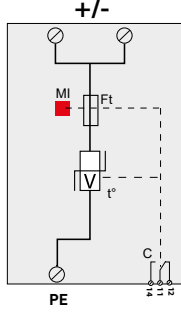

DS72RS-48DC

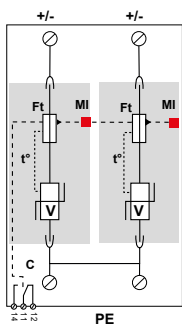

DS71R-48DC

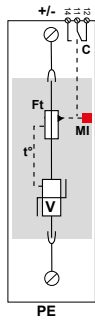

V: High energy varistor
 GSG: Specific Gas Tube
 MI: Disconnection indicator
 Ft: Thermal fuse
 t°: Thermal disconnection system
 C: Contact for remote signal

380-400 VDC POWER SURGE PROTECTORS TYPE 1 OR TYPE 2



- Surge protectors for 380-400 Vdc power lines
- Type 1 and Type 2
- I_{max} up to 70 kA
- I_{limp} up to 25 kA/pole
- Remote signaling option
- prIEC 61643-41 compliance

Characteristics

CITEL Model	DS252E-420DC	DS132RS-420DC	DDC50S-21Y-440	DS42VGS-450DC
Description	Type 1 DC power SPD	Type 1 DC power SPD	Type 2 DC power SPD	Type 2 DC power SPD
Nominal DC voltage	Un 400 Vdc	400 Vdc	400 Vdc	400 Vdc
Connection mode	+/-PE and -/-PE	+/-PE and -/-PE	+/-PE and -/-PE	+/-PE and -/-PE
Max. DC operating voltage	Uc 420 Vdc	420 Vdc	440 Vdc	450 Vdc
Residual current <i>Leakage current at Uc</i>	I _{pe} < 0.1 mA	< 0.1 mA	< 0.1 mA	None
Follow current	I _f None	None	None	None
Nominal discharge current <i>15 x 8/20 μs impulses</i>	I _n 15 kA	12.5 kA	20 kA	10 kA
Max. discharge current <i>max. withstand @ 8/20 μs by pole</i>	I _{max} 30 kA	50 kA	50 kA	40 kA
Max. lightning current by pole <i>max. withstand @ 10/350 μs</i>	I _{limp} 25 kA	12.5 kA	-	-
Total lightning current @ 10/350 μs	I _{total} 50 kA	50 kA	-	-
Protection level +/-PE (-/-PE) <i>@ In (8/20 μs)</i>	U _p 1.5 kV	1.5 kV	1.8 kV	1.5 kV
Protection level +/- @ In (8/20 μs)	U _p 3 kV	3 kV	1.8 kV	2.5 kV
Associated disconnectors				
Thermal disconnector	internal	internal	internal	internal
Fuses (if requested)	315 A max	125 A max	50-125 A max	50-125 A max
Mechanical characteristics				
Dimensions	see diagram 4 TE (EN43880)	see diagram 2 TE (EN43880)	see diagram 3 TE (EN43880)	see diagram 2 TE (EN43880)
Connection to Network	Screw terminals: 2.5-25 mm ²			
Failsafe mode	Disconnection from network			
Disconnection indicator	1 mechanical indicator/pole			
Remote signaling of disconnection	output on changeover contact			
Max. voltage/current for remote signaling	250 V/0.5 A (AC) / 30 V/3 A (DC)			
Wiring for remote signaling	Max. 1.5 mm ²			
Mounting	Symmetrical rail 35 mm (EN60715)			
Operating temperature	-40/+85°C			
Protection rating	IP20			
Housing material	Thermoplastic UL94-V0			
Spare unit	-	DSM130R-420DC	MDDC50-Y-440	DSM40VG-450DC
Standards				
Compliance	prIEC 61643-41			
Part number				
	64005	573312	-	42287132

DS132RS-420DC

DS42VGS-450DC

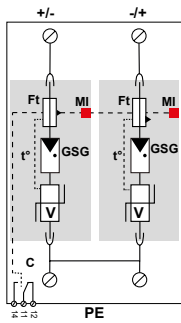
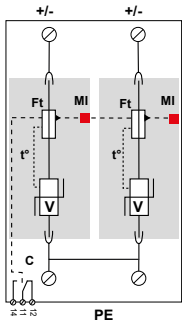

DDC50S-21Y

DS252E-420DC

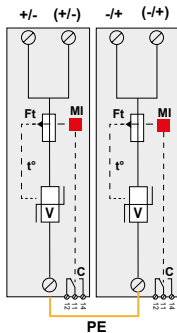
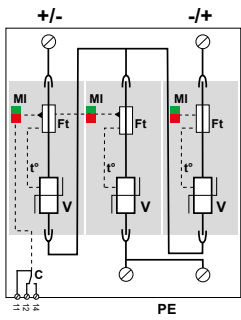

V: High energy varistor
GSG: Specific gas Tube
MI: Disconnection indicator
Ft: Thermal fuse
t°: Thermal disconnection system
C: Contact for remote signal

DDC30 SERIES



- 1-pole or 2-pole surge protector
- Pluggable module
- In: 15 kA / I_{max}: 30 kA
- Remote signaling (option)
- Iimp: 4 kA
- prIEC 61643-41 compliance

DDC30S-x0-xx

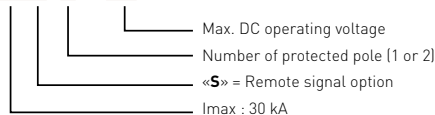

Characteristics

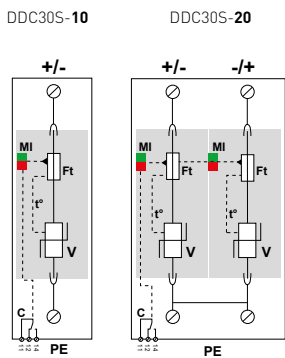
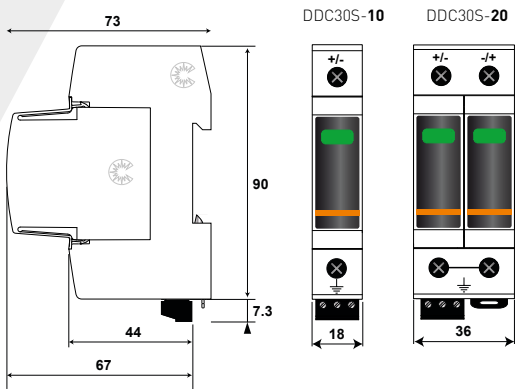

V: High-energy varistor
 Ft: Thermal fuse
 C: Remote signaling contact
 t[°]: Thermal disconnection system
 Mi: Disconnection indicator

CITEL Model	DDC30-10-65	DDC30-10-85	DDC30-20-65	DDC30-20-85
Description	1-pole DC surge protector		2-pole DC surge protector	
Nominal DC voltage	Un	48 Vdc	48 Vdc	75 Vdc
Connection mode	+/-PE and -/PE	+/-PE and -/PE	+/-PE and -/PE	+/-PE and -/PE
Max. DC operating voltage	Uc-DC	65 Vdc	85 Vdc	65 Vdc
Max. AC operating voltage	Uc-AC	50 Vac	60 Vac	50 Vac
Residual current <i>Leakage current at Uc</i>	I _{pe}	< 0.1 mA	< 0.1 mA	< 0.1 mA
Follow current	I _f	None	None	None
Nominal discharge current <i>15 x 8/20 μs impulses</i>	I _n	15 kA	15 kA	15 kA
Max. discharge current <i>max. withstand @ 8/20 μs by pole</i>	I _{max}	30 kA	30 kA	30 kA
Total discharge current @ 8/20μs	I _{max total}	60 kA	60 kA	60 kA
Max. lightning current by pole <i>max. withstand @ 10/350μs</i>	I _{imp}	4 kA	4 kA	4 kA
Protection level +/-PE (-/PE) <i>@ In (8/20μs)</i>	U _p	300 V	390 V	300 V
Protection Level +/- @In (8/20μs)	U _p	-	-	600 V
Associated disconnectors				
Thermal disconnector	internal			
Fuses (if requested)	50 A min. - 125 A max. -Fuses type gG			
Mechanical characteristics				
Dimensions	see diagram - 1 TE (EN43880)		see diagram - 2 TE (EN43880)	
Connection to Network	Screw terminals: 2.5-25 mm ² +/- : 1.5-10 mm ²			
Failsafe mode	Disconnection from network			
Disconnection indicator	1 mechanical indicator Green/Red		2 mechanical indicators, Green/Red	
Remote signaling of disconnection output on changeover contact	option DDC30S-10-65	option DDC30S-10-85	option DDC30S-20-65	option DDC30S-20-85
Max. voltage/current for remote signaling	250 V/0.5 A (AC) / 30 V/3 A (DC)			
Wiring for remote signaling	Max. 1.5 mm ²			
Mounting	Symmetrical rail 35 mm (EN60715)			
Operating temperature	-40/+85°C			
Protection rating	IP20			
Housing material	Thermoplastic UL94-V0			
Spare unit	MDDC30-65	MDDC30-85	MDDC30-65	MDDC30-85
Standards				
Compliance	prIEC 61643-41			
Part number				
	828110111	828110211	828110112	828110212



DDC50-21Y SERIES

- DC power Type 2 SPD
- for Energy Storage System/EV Charging
- up to 1200 V DC voltage
- In/Imax: 20/50 kA
- Pluggable modules
- Remote signaling (option)
- prIEC 61643-41 compliance

DDC50S-21Y-xxxx

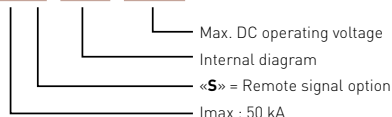

Characteristics

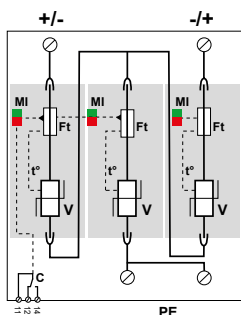
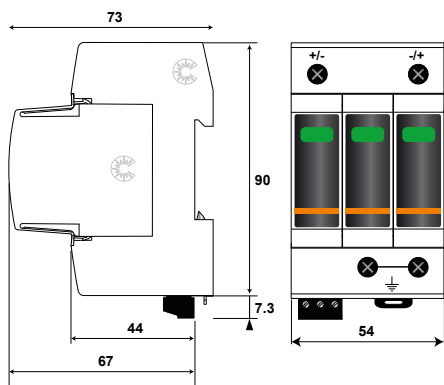

V: High-energy varistor
 Ft: Thermal fuse
 C: Remote signaling contact
 t°: Thermal disconnection system
 Mi : Disconnection indicator

CITEL Model	DDC50-21Y-500	DDC50-21Y-800	DDC50-21Y-1200	DDC50-21Y-1500
Description	DC power surge protector			
Nominal DC voltage	Un 450 Vdc	650 Vdc	1000 Vdc	1200 Vdc
Max. DC operating voltage	Uc 500 Vdc	800 Vdc	1200 Vdc	1500 Vdc
Residual current <i>Leakage current at Uc</i>	Ipe < 0.1 mA	< 0.1 mA	< 0.1 mA	< 0.1 mA
Nominal discharge current <i>15 x 8/20 μs impulses</i>	In 20 kA	20 kA	20 kA	20 kA
Max. discharge current <i>max. withstand @ 8/20 μs by pole</i>	Imax 50 kA	50 kA	50 kA	50 kA
Max. lightning current by pole <i>max. withstand @ 10/350μs</i>	Iimp 4 kA	4 kA	4 kA	4 kA
Protection level +/-PE [-/PE] <i>@ In (8/20μs)</i>	Up 2.1 kV	2.7 kV	3.6 kV	5.1 kV
Protection level @ In (8/20μs) +/-	Up 2.1 kV	2.7 kV	3.6 kV	5.1 kV
Admissible Short circuit current	Iscrr 100 000 A	100 000 A	100 000A	100 000 A
Associated disconnectors				
Thermal disconnector	internal			
Fuses	50 A min. (Iscrr 100 kA)- 125 A max. (Iscrr 50 kA) - High voltage DC Fuses			
Mechanical characteristics				
Dimensions	see diagram - 3 TE (EN43880)			
Connection to Network	Screw terminals: 2.5-25 mm ²			
Failsafe mode	Disconnection from network			
Disconnection indicator	3 mechanical indicators Green/Red			
Remote signaling of disconnection output on changeover contact	option	option	option	option
Max. voltage/current for remote signaling	250 V/0.5 A (AC) / 30 V/3 A (DC)			
Wiring for remote signaling	Max. 1.5 mm ²			
Mounting	Symmetrical rail 35 mm (EN60715)			
Operating temperature	-40/+85°C			
Protection rating	IP20			
Housing material	Thermoplastic UL94-V0			
Spare unit	MDDC50-500	MDDC50-800	MDDC50-1200	MDDC50-1500
Standards				
Compliance	prIEC 61643-41			
Part number				
	828511253	828511353	82851563	82851663



DDCxxC SERIES



- Surge protector for DC or PV powerlines
- From 12 to 350 Vdc
- Compact design
- Remote signaling (option)
- prIEC 61643-41 and UL1449 ed.4 compliance

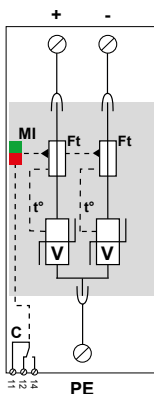
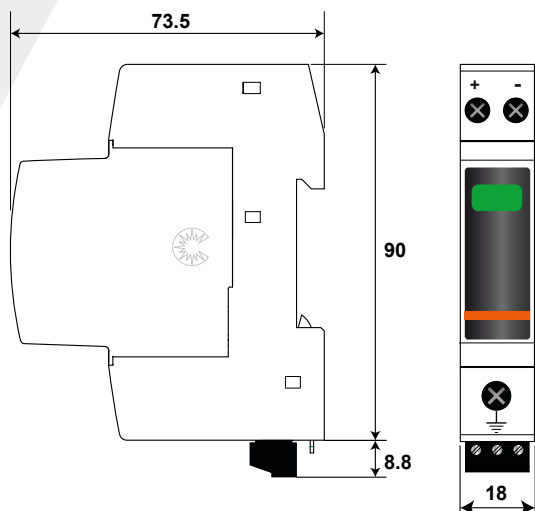

C: Remote signalling contact
 V: Varistor
 Ft: Thermal fuse
 t°: Thermal disconnection system
 MI : Disconnection indicators

Characteristics

CITEL Model	DDC20C-20-24	DDC20C-20-38	DDC30C-20-65
Network	12Vdc	24Vdc	48 Vdc
Connection mode	+/-/PE	+/-/PE	+/-/PE
Max. DC operating voltage	Uc 24 Vdc	38 Vdc	65 Vdc
Max. AC operating voltage	Uc 20 Vac	30 Vac	50 Vac
Max. operating voltage PV-DC	Ucpv 24 Vdc	38 Vdc	65 Vdc
Permanent operating current @ Ucpv	Icpv < 0.1 mA	< 0.1 mA	< 0.1 mA
Residual current <i>Leakage current at Uc</i>	Ipe < 0.1 mA	< 0.1 mA	< 0.1 mA
Follow current	If None	None	None
Nominal discharge current <i>15 x 8/20 μs impulses</i>	In 10 kA	10 kA	15 kA
Max. discharge current <i>max. withstand @ 8/20 μs by pole</i>	I _{max} 20 kA	20 kA	30 kA
Total discharge current @ 8/20μs	I _{max-total} 40 kA	40 kA	60 kA
Protection level +/-PE (-/PE) @ In (8/20μs)	Up 250 V	250 V	300 V
Protection level +/- @ (8/20μs)	Up 500 V	500 V	600 V
Admissible short circuit current	I _{sc} 10 000 A	10 000 A	10 000 A
Current withstand short circuit PV	I _{scpv} 1000 A	1000 A	1000 A
Associated disconnectors			
Thermal disconnector	internal		
Fuses (if required)	20 A min - 125 A max - Type gG		
Mechanical characteristics			
Dimensions	see diagram, 1 TE (EN43880)		
Connection to Network	by screw terminals: 1.5-10mm ² (actives wires) and 2.5-25mm ² (ground)		
Disconnection indicator	1 mechanical indicator, Green/Red		
Failure mode	Disconnection from network		
Remote signaling of disconnection output on changeover contact	Option DDC20CS-20-24	Option DDC20CS-20-38	Option DDC30CS-20-65
Max. voltage/current for remote signaling	250 V/0.5 A (AC) / 30 V/3 A (DC)		
Wiring for remote signaling	Max. 1.5 mm ²		
Mounting	Symmetrical rail 35 mm (EN60715)		
Operating temperature	-40/+85°C		
Protection rating	IP20		
Housing material	Thermoplastic UL94-V0		
Spare unit	MDDC20C-20-24	MDDC20C-20-38	MDDC30C-20-65
Standards			
Compliance	prIEC61643-41/ UL1449 ed.4		
Part number			
	-	-	-

COMPACT TYPE 2 DC POWER SURGE PROTECTOR

DDCxxCS-20-xxx

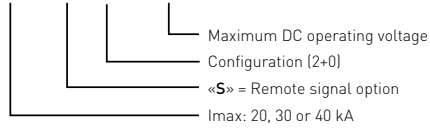

DDC40C-20-100	DDC40C-20-125	DDC40C-20-150	DDC40C-20-180	DDC40C-20-275	DDC40C-20-350	DDC40C-20-460
75 Vdc	95 Vdc	110 Vdc	130 Vdc	220 Vdc	280 Vdc	350 Vdc
+/-/PE	+/-/PE	+/-/PE	+/-/PE	+/-/PE	+/-/PE	+/-/PE
100 Vdc	125 Vdc	150 Vdc	180 Vdc	275 Vdc	350 Vdc	460 Vdc
75 Vac	95 Vac	115 Vac	150 Vac	210 Vac	275 Vac	350 Vac
100 Vdc	125 Vdc	150 Vdc	180 Vdc	275 Vdc	350 Vdc	460 Vdc
< 0.1 mA	< 0.1 mA	< 0.1 mA	< 0.1 mA	< 0.1 mA	< 0.1 mA	< 0.1 mA
< 0.1 mA	< 0.1 mA	< 0.1 mA	< 0.1 mA	< 0.1 mA	< 0.1 mA	< 0.1 mA
None	None	None	None	None	None	None
20 kA	20 kA	20 kA	20 kA	20 kA	20 kA	20 kA
40 kA	40 kA	40 kA	40 kA	40 kA	40 kA	40 kA
80 kA	80 kA	80 kA	80 kA	80 kA	80 kA	80 kA
390 V	450 V	500 V	620 V	900 V	1200 V	1400 V
780 V	900 V	1000 V	1200 V	1800 V	2400 V	2800 V
10 000 A	10 000 A	10 000 A	10 000 A	10 000 A	10 000 A	10 000 A
1000 A	1000 A	1000 A	1000 A	1000 A	1000 A	1000 A
50 A min. - 125 A max. - Type gG						
Option DDC40CS-20-100	Option DDC40CS-20-125	Option DDC40CS-20-150	Option DDC40CS-20-180	Option DDC40CS-20-275	Option DDC40CS-20-350	Option DDC40CS-20-460
MDDC40C-20-100 MDDC40C-20-125 MDDC40C-20-150 MDDC40C-20-180 MDDC40C-20-275 MDDC40C-20-350 MDDC40C-20-460						
-	-	-	-	-	-	-

DS210-xxDC SERIES



- Surge protector for DC or PV powerlines
- From 12 to 130Vdc
- I_{max}: 2 to 6 kA
- Operating indicator
- Pluggable module
- EN 61643-11, CEI 61643-11 and UL1449 ed.4 compliance

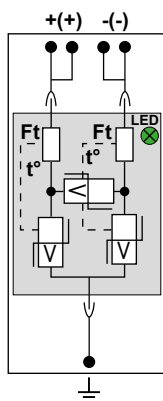
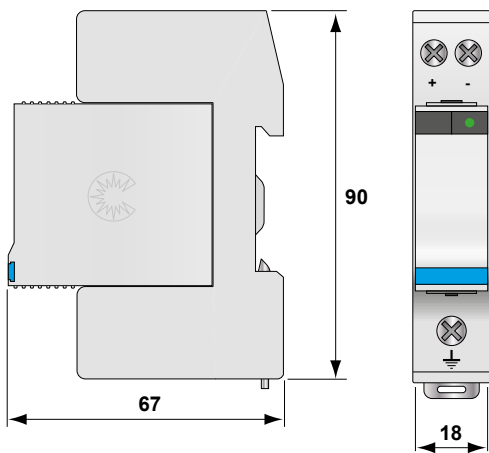

V: Varistor
 Ft: Thermal fuse
 t°: Thermal disconnection system
 LED : Disconnection indicator

Characteristics

CITEL Model	DS210-12DC	DS210-24DC	DS210-48DC
Description	DC or PV power surge protector		
Network	12 Vdc	24 Vdc	48 Vdc
Connection mode	+/-/PE	+/-/PE	+/-/PE
Protection mode(s)	CM/DM	CM/DM	CM/DM
Max. DC operating voltage	Uc 15 Vdc	30 Vdc	56 Vdc
Max. AC operating voltage	Uc 10 Vac	15 Vac	40 Vac
Max. PV-DC operating voltage	Ucpv 15 Vdc	30 Vdc	56 Vdc
Permanent operating current @ Ucpv	Icpv < 0.1 mA	< 0.1 mA	< 0.1 mA
Residual current <i>Leakage current at Uc</i>	Ipe < 0.1 mA	< 0.1 mA	< 0.1 mA
Max. Load current <i>(if connection serie)</i>	IL 20 A	20 A	20 A
Nominal discharge current <i>15 x 8/20 μs impulses</i>	In 1 kA	1 kA	2 kA
Max. discharge current <i>max. withstand @ 8/20 μs by pole</i>	I _{max} 2 kA	2 kA	6 kA
Protection level +/-PE (-/PE) <i>@ In (8/20μs)</i>	Up 85 V	105 V	180 V
Associated disconnectors			
Thermal disconnector	internal		
Fuses (if resquested)	Fuses type gG- 10 A		
Mechanical characteristics			
Dimensions	see diagram		
Connection to Network	by screw terminals: 1.5-10mm ² (actives wires) and 2.5-25mm ² (ground)		
Disconnection indicator	Green led off		
Mounting	Symmetrical rail 35 mm (EN60715)		
Operating temperature	-40/+85°C		
Protection rating	IP20		
Housing material	Thermoplastic UL94-V0		
Spare unit	DSM210-12DC	DSM210-24DC	DSM210-48DC
Standards			
Compliance	IEC 61643-11 / EN 61643-11 / UL1449 ed.4		
Part number			
	440201	440301	440401

DC POWER SURGE PROTECTOR

DS210-xxxDC

Nominal DC voltage

DS210-75DC	DS210-95DC	DS210-110DC	DS210-130DC
75 Vdc	95 Vdc	110 Vdc	130 Vdc
+/-/PE	+/-/PE	+/-/PE	+/-/PE
CM/DM	CM/DM	CM/DM	CM/DM
85 Vdc	100 Vdc	125 vdc	150 Vdc
60 Vac	75 Vac	95 Vac	115 Vac
85 Vdc	100 Vdc	125 Vdc	150 Vdc
< 0.1 mA	< 0.1 mA	< 0.1 mA	< 0.1 mA
< 0.1 mA	< 0.1 mA	< 0.1 mA	< 0.1 mA
20 A	20 A	20 A	20 A
2 kA	2 kA	2 kA	2 kA
6 kA	6 kA	6 kA	6 kA
250 V	300 V	350 V	400 V
DSM210-75DC	DSM210-95DC	DSM210-110DC	DSM210-130DC
440601	441001	440901	440602

TYPE 2 (OU 3) DC POWER SURGE PROTECTOR



DDCN-DC SERIES



- SPD for 24 or 48 V DC
- Series Connection (2-port)
- Type 2 (or Type 3)
- In: from 1.5 kA / I_{max}: up to 6 kA
- Monobloc
- Remote signaling (option)
- prIEC 61643-41 compliance

DDCN_{xx}S-x21YG-_{xx}

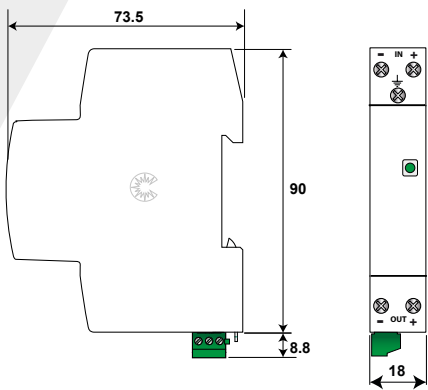
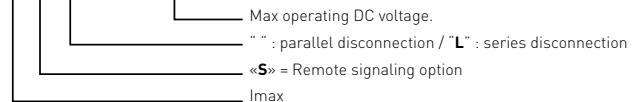

DDCN*-21YG-*

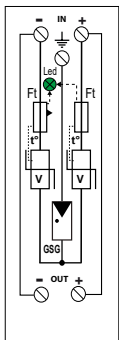

DDCN*-L21YG-*

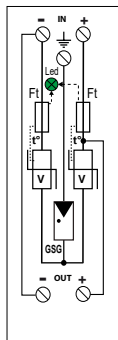

DDCN*S-21YG-*

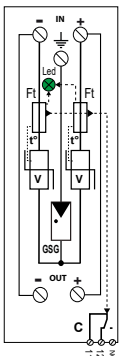

DDCN*S-L21YG-*

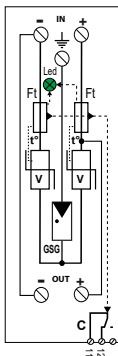

V: Varistor
 GSG : Specific Gas Tube
 Ft: Thermal fuse
 t°: Thermal disconnection system
 LED : Disconnection indicator
 C : Remote signaling contact

Characteristics

CITEL Model		DDCN03-21YG-30	DDCN06-21YG-65
Description		Type 2 (ou 3) , 2-port DC power SPD	
Nominal DC voltage	Un	24 Vdc	48 Vdc
Connection mode		+/-/PE	+/-/PE
Maximal operating voltage.	Uc	30 Vdc	65 Vdc
Max load current	IL	25 A	25 A
Residual current	I _{pe}	none	none
Leakage current @ U _c			
Nominal discharge current	In	1.5 kA	2 kA
15 x 8/20 μs impulses			
Max. discharge current	I _{max}	3 kA	6 kA
max. withstand @ 8/20 μs by pole			
Withstand in combination waveform	U _{oc}	3 kV	4 kV
Classe III Test			
Protection level +/-	U _p	0.2 kV	0.5 kV
@ In (8/20 μs)			
Protection level +/-PE (or -/PE)	U _p	0.8 kV	0.8 kV
@ In (8/20 μs)			
Associated disconnectors			
Thermal disconnector		internal	
Fuses (if resquested)		25 A type gG	
Mechanical characteristics			
Dimensions		see diagram , 1 TE (EN43880)	
Connection to Network		by screw 1.5-10 mm ²	
Failure mode		Disconnection	
Operation indication		Green indicator ON	
Disconnection indication		Green indicator OFF	
Parallel Disconnection Mode		DDCN03-21YG-30	DDCN06-21YG-65
Mode de déconnexion série		DDCN03-L21YG-30	DDCN06-L21YG-65
Coupeure du réseau AC			
avec Télésignalisation de défaut		DDCN03S-21YG-30	DDCN06S-21YG-65
sortie sur contact NC		DDCN03S-L21YG-30	DDCN06S-L21YG-65
Max. Voltage/current for Remote signaling		250 V/0.5 A (AC) / 30 V/3 A (DC)	
Remote signaling wiring		max. 1.5 mm ²	
Mounting		Symmetrical rail 35 mm (EN60715)	
Operating temperature		-40/+85°C	
Protection rating		IP20	
Housing material		Thermoplastic UL94-V0	
Standards			
Compliance		IEC 61643-11, prIEC 61643-41	
Part Number			
Standard Version		DDCN03-21YG-30 70124041	DDCN06-21YG-65 70134051
Series disconnection Version		DDCN03-L21YG-30 70125041	DDCN06-L21YG-65 70135051
Remote signaling Version		DDCN03S-21YG-30 70124042	DDCN06S-21YG-65 70134052
Remote signaling & Series disconnection Version		DDCN03S-L21YG-30 70125042	DDCN06S-L21YG-65 70135052



CITEL



CITEL

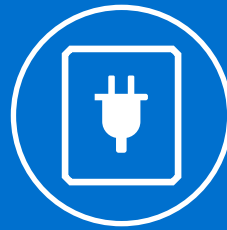
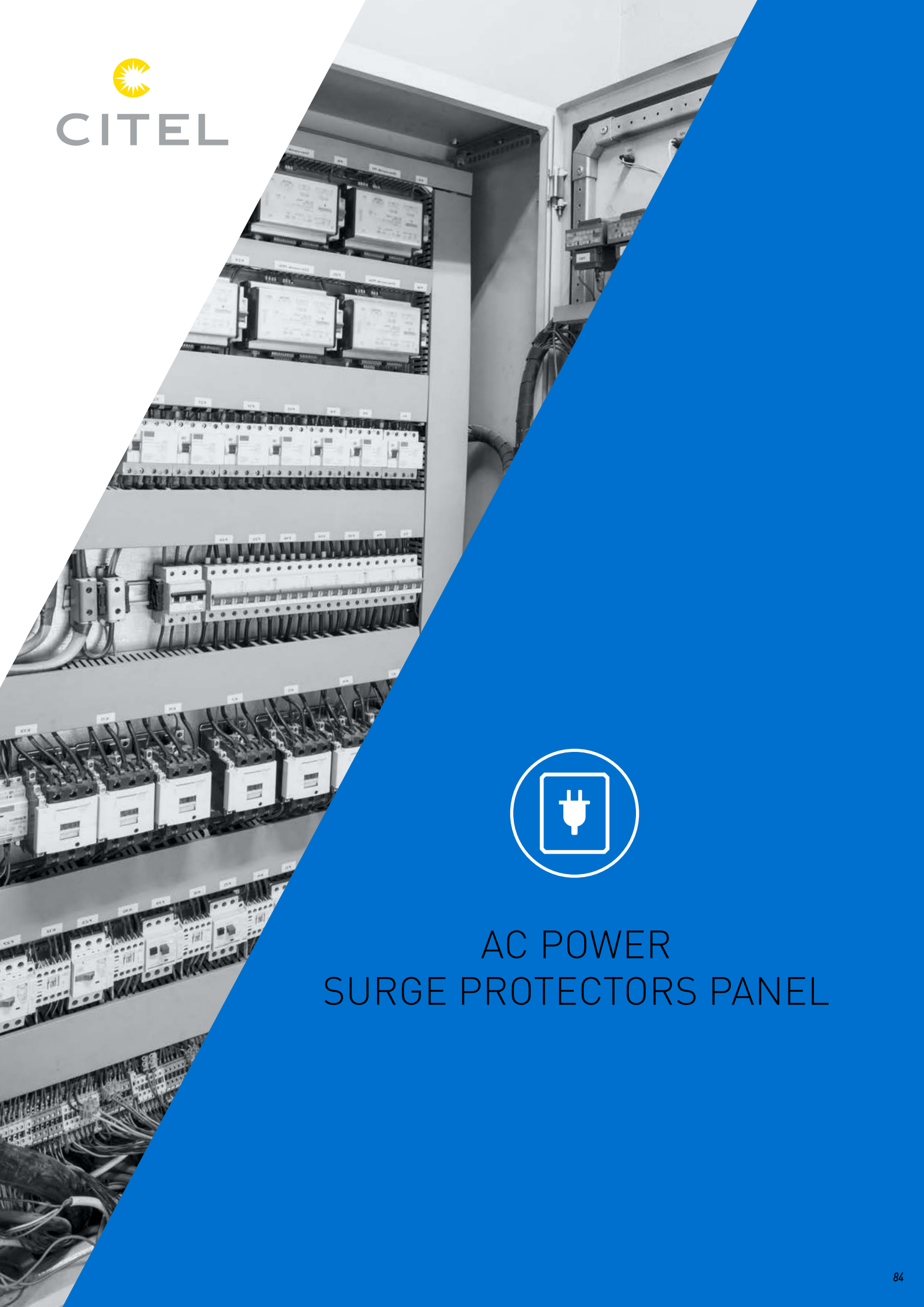

AC POWER SURGE PROTECTORS PANEL

AC SURGE PROTECTORS HARD-WIRED UNITS AND COMBINER BOXES

CITEL offers a line of surge protectors for the single and three phase AC networks connected to sensitive equipment. These products, are available in various formats

- Hard-wired units single-phase (MSB, MLP)
- Hard-wired units and combiner box for US market (M series)

Series		Description	Characteristics	Page
MSB		Hard-wired SPD Type 2 or 3	compact	87 89
M50		Hard-wired SPD US market	Single-phase or 3-phase	91
MS MDS		SPD combiner boxes US market	Compliance UL1449 80 to 200 kA	90 93

HARD-WIRED SURGE PROTECTORS

MSB series

SPDs Type 2 or 3 for effective protection of sensitive equipment, in addition to the surge protector installation (coordination surge protector). Recommended installation near a sensitive equipment away from the surge protector (> 10 m). These surge protectors utilize a compact and economical scheme based varistors, to obtain a power flow relevant for secondary protection. They are more in accordance with IEC 61643-11, equipped with internal security which will disconnect the product of their networks for end of life. The operating condition of the arrester is signaled by light (or buzzer for version MSB6). Available in screw terminal connectors or wire terminals.

MLP/MLPC/MLPM series

Complete ranges of compact surge protectors specifically designed for the protection of outdoor lighting equipment with LED technology (see page 93).

STAND ALONE SPD ENCLOSURES

M series

M series surge protection devices (M50, MS and MDS) in metal enclosures belong to a complete family of surge protection devices specifically designed to meet the requirements of the North American surge protection standards: USA and Canada. Respectively, the UL1449 ed4 standard and the C22.2 No.269.1-22.2 No.269.5 standards. These standards define different categories of surge protection devices (SPD) and unfortunately use very close or identical terms compared to the SPD classification used in International standards. It is therefore crucial not to confuse these terms and understand their meaning based on the reference standards.

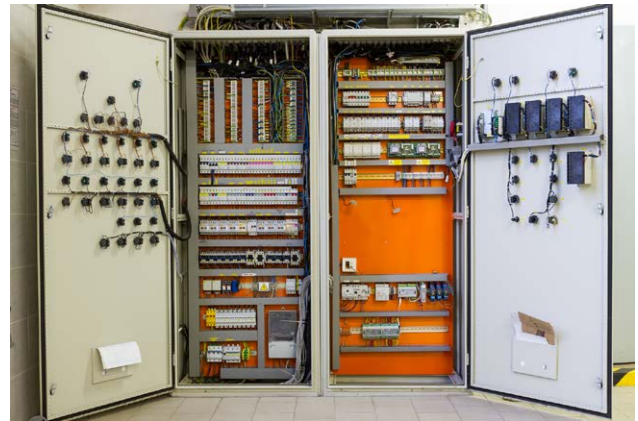

UL STANDARDS

The north American standard applicable to AC power SPD (UL1449 4th edition) proposes a different approach and classification from the international standard (IEC61643-11)

Type 1 - Permanently connected surge protection devices to be installed both, on the supply side and the load side of the equipment main overcurrent protective device. The surge protection devices are supposed to be self-protected against short circuits and do not require external protection.

Type 2 - Permanently connected surge protection devices to be installed on the load side of the equipment main overcurrent protective device. This surge protection device requires an external short circuit protection device.

Type 3 - Surge protection devices installed at a conductor length of 10 meters or greater from the electrical panel. For example, the mobile surge protectors (that can be plugged into the outlet such as a multiple power outlet etc.). They can also be directly installed on the equipment to be protected.

Type 4 « Component Assemblies » - Component Assemblies consisting of one or more Type 5 components and a disconnect complying with the limited end-of-life short circuit current tests (0.5A, 2.5A, 5A and 10A).

Type 1, 2, 3 « Component Assemblies » - Type 4 Component Assemblies having, in addition to the limited end-of-life short circuit current tests, passed all the other end-of-life tests (under the short circuit current of 100A, 500A, 1000A and SCCR) and also with (2CA) or without (1CA) external short circuit protection

Type 5 - Discrete component surge suppressors, such as MOVs, Diode or GDT that may be mounted on a PCB, connected by its leads or provided within an enclosure with mounting means and wiring terminations.

It is therefore clear from these definitions that Type 1 and Type 2

surge protection devices (according to the US-accepted terminology) are not necessarily linked to potential surge hazard as it is in the International approach (IEC). In UL standard, Type 1 and Type 2 surge protection devices are determined by the fact whether or not they need a short circuit protection. However, depending on the impulse tests, the minimum levels required for a Type 1, Type 2 and Type 3 surge protection devices are as follows :

Type 1 – 10kA or 20kA 8/20

Type 2 – 3kA, 5kA, 10kA or 20kA 8/20

Type 3 – 6kV/3kA 1,2/50-8/20

It is also understood that the location of the surge protection device imposed by its type is related to a certain stress level naturally being such that: the closer the surge protection device is to the mains connection point the greater its ability to withstand the surge.

Note that the maximum nominal discharge current is set at 20 kA (equivalent to International nominal discharge current (In) but it has no limitation and much lower in energy than the maximum impulse current (Iimp) of International Type 1).

Also important to remember that even if it is very tempting to compare the American voltage protection rating (VPR) and the International voltage protection level (Up), they are not (yet) comparable. The VPR is determined for any type of American SPD by using by a 6 kV/3 kA combination waveform generator.

The concept of “Listed” or “Recognized”

is important to understand particularly regarding the installation according to the American installation rules. A listed product is a device that any electrician can install on an installation (on site) without compromising safety. A recognized device cannot be installed on an installation. It can only be installed on a piece of equipment or a system (e.g. electrical cabinet) by professionals, at the factory, following certain rules and may be a subject to additional tests.

I_{max} parameter

Another disconcerting and confusing aspect is the maximum discharge current (I_{max}) values indicated for American surge protection devices:

- For an International surge protection device, the I_{max} value is defined by standards and must be tested if declared.

- For an American surge protection device, I_{max} has no official definition and is completely open to various interpretations by users and manufacturers.

The easiest interpretation is that the I_{max} does not represent a maximum single shock that the surge protection device can withstand but reflects its durability. This I_{max} is the algebraic sum of the individual I_{max} values of possible multiple varistors connected in parallel for each declared protection mode.

For example, if the protection mode (common in the USA) phase with the neutral and the ground connected (usually called “per phase”) consists of 5 varistors between the line and the neutral and 5 varistors between the line and the earth (each varistor having an individual I_{max} value of 40kA), the final declared I_{max} value will be 5x40+5x40=400kA...

This type of value totally escapes from the International logic but is useful information for American users as it gives an idea of the surge protection device capacity in terms of its service life.

Other example, a surge protection device with a In of 20kA and declared I_{max} of 40kA will not be able to withstand much more than 20 shocks of 20kA. On the other hand, a surge protection device having the same In of 20kA and declared I_{max} of 400kA will be able to withstand more than 2000 shocks of 20kA!

Conversely, the International Type 1 design with its characteristic of 10/350 wave maximum impulse current (Iimp) is completely unknown (and rejected) in the USA.

4 th Edition	Line Side of Main Disconnect	Load Side of Main Disconnect	Local Equipment	Surge component + Thermal Disconnect (component assembly)	Surge Component Only
	<i>No upstream fuse requested</i>	<i>Upstream fuse requested</i>	<i>Upstream fuse requested + distant 30ft from main panel</i>	<i>To be used in equipment/panel. UL additional tests expected</i>	<i>To be used in equipment UL additional test expected</i>
Listed	Type 1	Type 2	Type 3	-	-
Listed + condition (enclosure) (a)	Open- Type 1	Open- Type 2	Open- Type 3	-	-
Recognized (b)	Type 1CA	Type 2CA	Type 3CA	Type 4CA	Type 5
Required Tests	- SCCR - Intermediate - Limited (10, 5, 2.5 , 0.5 A) - VPR at 6kV/3kA - Nominal Discharge Current (15 x In: 10, 20 kA) - -	- SCCR - Intermediate - Limited (10, 5, 2.5 , 0.5 A) - VPR at 6kV/3kA - Nominal Discharge Current (15 x In: 3, 5, 10, 20 kA) - -	- - Limited (10, 5, 2.5 , 0.5 A) - VPR at 6kV/3kA - - Operating Duty Cycle (6kV/3kA x 15) -	- - Limited (10, 5, 2.5 , 0.5 A) - - Nominal Discharge Current (15 x In: 10, 20 kA) - - MLV at In	- - - - Nominal Discharge Current (15 x In: 10, 20 kA) - - MLV at In
Optional Tests			- Nominal Discharge Current (In x 15)		

(a) field wiring. Can be installed by any electrician on field

(b) factory wiring/use. Cannot be installed on field.

Must be installed in certified factorvor in products (Listed or recognized)

MSB10 SERIES



MSB10-400(UL)

- Compact Type 2 and 3 surge protectors
- Wall mounting and hard wired connection
- UL1449 4ed. and IP66 (MSB10-400)
- Status indicators
- EN 61643-11, IEC 61643-11 and UL1449 4ed. compliance



Characteristics

CITEL Model	MSB10-400(UL)	MSB10-480(UL)	MSB10-400	MSB10-120	MSB10V-400	MSB10V-120	MSB10C-400
Description	Compact Type 2/3 hard wired SPD						
Network	230 V single phase	347-480 Vac single phase	230 V single phase	120 V single phase	230 V single phase	120 V single phase	230 V single phase
AC system	TT-TN	TT/TN	TT-TN	TT/TN	TT-TN	TT/TN	TT-TN
Protection mode(s)	CM/DM	CM/DM	CM/DM	CM/DM	CM/DM	CM/DM	CM/DM
Max. AC operating voltage	Uc 300 Vac	550 Vac	255 Vac	150 Vac	255 Vac	150Vac	255 Vac
Max. Load current	IL -	-	-	-	16 A	16 A	16 A
Residual current <i>Leakage current at Uc</i>	Ic < 1 mA	< 1 mA	None	None	None	None	None
Temporary Over Voltage (TOV) <i>Characteristics - 5 sec.</i>	UT 335 Vac withstand	700 Vac withstand	335 Vac withstand	180 Vac withstand	335 Vac withstand	180 Vac withstand	335 Vac withstand
Temporary Over Voltage (TOV) <i>Characteristics - 120 mn</i>	UT 440 Vac disconnection	915 Vac disconnection	440 Vac disconnection	230 Vac disconnection	440 Vac disconnection	230 Vac disconnection	440 Vac disconnection
Nominal discharge current	In 3 kA	3 kA	3 kA	3 kA	3 kA	3 kA	3 kA
Max. discharge current <i>max. withstand @ 8/20 μs by pole</i>	Imax 10 kA	10 kA	10 kA	10 kA	10 kA	10 kA	10 kA
Withstand on Combination waveform <i>Class III test</i>	Uoc 6 kV	6 kV	6 kV	6 kV	6 kV	6 kV	6 kV
Withstand on overvoltages <i>IEEE C62.41.1</i>	10 kV/10 kA	10 kV/10 kA	10 kV/10 kA	10 kV/10 kA	10 kV/10 kA	10 kV/10 kA	10 kV/10 kA
Protection level CM/DM <i>@In (8/20μs) and @ 6kV (1.2/50μs)</i>	Up 1.2 kV/1.2 kV	2 kV/2 kV	1.5 kV/1.5 kV	1 kV/1 kV	1.5 kV/1.5 kV	1 kV/1 kV	1.5 kV/1.5 kV
Admissible short-circuit current	Iscsr 10 000 A	10 000 A	10 000 A	10 000 A	10 000 A	10 000 A	10 000 A
Associated disconnectors							
Thermal disconnector	internal						
Installation ground fault breaker	Type «S» or delayed						
Mechanical characteristics							
Dimensions	see diagram						
Connection to Network	wires	wires	wires	wires	screw terminal	screw terminal	screw terminal
Voltage/operating indicator	Green led ON						
Failsafe behavior	Disconnection	Disconnection	Disconnection	Disconnection	Disconnection and AC line cut-off	Disconnection and AC line cut-off	Disconnection and AC line cut-off
Disconnection indicator	Green led OFF						
Mounting	Wall or plate						
Operating temperature	-40/+85°C						
Protection rating	IP66	IP66	IP65	IP65	IP20	IP20	IP20
Housing material	Thermoplastic UL94 V-0						
Standards							
Compliance	IEC 61643-11 / EN 61643-11 / UL1449 ed.4						
Certification	UL / EAC / TUV	UL / EAC	EAC	EAC	EAC	EAC	EAC
Part number							
	561501	561801	561201	561601	561101	561602	561301

HARD-WIRED AC SURGE PROTECTORS



MSB10C



MSB10V



MSB10

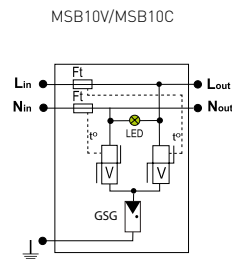
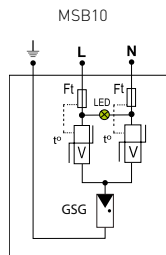
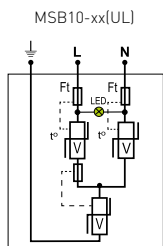
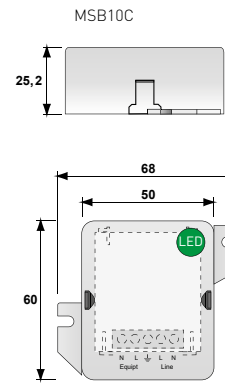
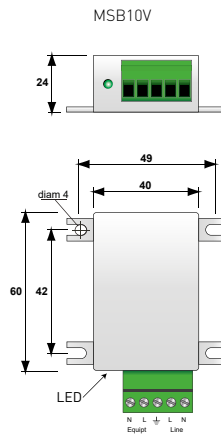
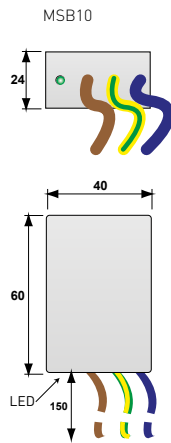
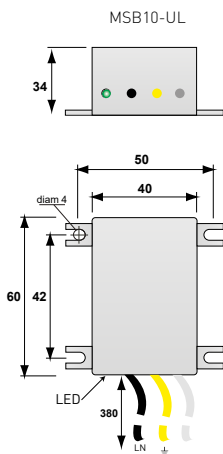

- V: Varistor
- Ft: Thermal fuse
- T°: Thermal system disconnection
- GSG: Specific Gas Tube
- LED: Disconnection indicator



MSB6 SERIES



- Ultra Compact Type 3 surge protectors for 230 Vac networks
- Mounting on plate or terminal
- Disconnection signaling by buzzer or Led system
- 24 V AC or DC version available
- EN 61643-11, IEC 61643-11 and UL1449 4ed. compliance

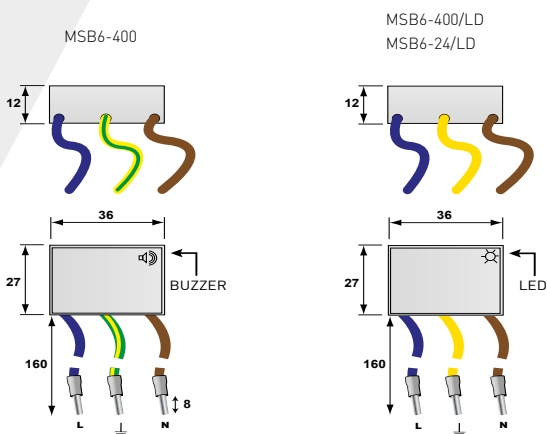

Characteristics

CITEL Model	MSB6-400	MSB6-24/LD	MSB6-400/LD
Description	Compact Type 3 hard wired SPD	Ultra Compact Type 3 hard wired SPD	Ultra Compact Type 3 hard wired SPD
Network	230 V single phase	24 Vac-30Vdc	230 V single phase
AC system	TT-TN	-	TT-TN
Protection mode(s)	CM/DM	CM/DM	CM/DM
Max. AC operating voltage	Uc 255 Vac	30 Vac-38 Vdc	255 Vac
Residual current	Ic None	None	None
Leakage current at Uc			
Temporary Over Voltage (TOV) Characteristics - 5 sec.	UT 335 Vac withstand	36 Vac withstand	335 Vac withstand
Temporary Over Voltage (TOV) Characteristics - 120 mn	UT 440 Vac disconnection	42 Vac disconnection	440 Vac disconnection
Nominal discharge current <i>15 x 8/20 μs impulses</i>	In 3 kA	0.5 kA	3 kA
Max. discharge current <i>max. withstand @ 8/20 μs by pole</i>	Imax 6 kA	2 kA	6 kA
Withstand on Combination waveform - Class III test	Uoc 6 kV	1 kV	6 kV
Withstand on overvoltages <i>IEEE C62.41.1</i>	6 kV/6 kA	-	6 kV/6 kA
Protection level CM/DM <i>@In (8/20μs) and @ 6kV (1.2/50μs)</i>	Up 1.5 kV/1.5 kV	0.18 kV/0.18 kV	1.5 kV/1.5 kV
Admissible short-circuit current	Iscrr 3 000 A	3 000 A	3 000 A

Associated disconnectors	
Thermal disconnector	internal
Installation ground fault breaker	Type «S» or delayed

Mechanical characteristics			
Dimensions	see diagram		
Connection to Network	wires		
Voltage/operating indicator	without	Green Led ON	Green Led ON
Failsafe behavior	Disconnection		
Disconnection indicator	buzzer ON	Led OFF	Led OFF
Mounting	AC outlet or screw terminal	AC outlet or screw terminal	AC outlet or screw terminal
Operating temperature	-40/+85°C		
Protection rating	IP20		
Housing material	Thermoplastic UL94 V-0		

Standards	
Compliance	IEC 61643-11 / EN 61643-11 / UL1449 ed.4

Part number	
561302	561313
	561312

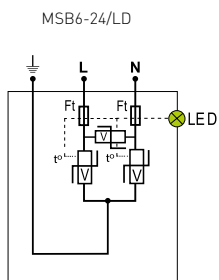
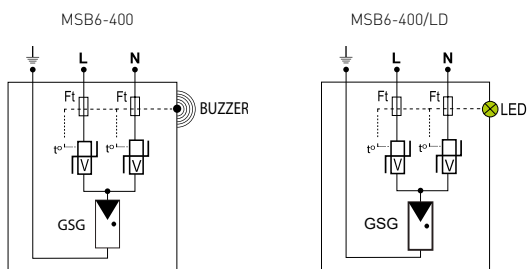

V: Varistor
 Ft: Thermal fuse
 LED: Disconnection indicator
 T°: Thermal system disconnection
 GSG: Specific Gas Tube
 Buzzer : Sound disconnection indicator



SERIES MS



- I_{max} from 105 to 220 kA (8/20μs)
- All mode of protection
- 200 kA short-circuit fault current rated
- Multi-redundant protection circuit per phase
- Full on-board diagnostics - LED indicators, remote and audible alarms
- EMI/RFI noise filtering (option)
- NEMA 4/4X/12 enclosure
- UL 1449 4th Ed. Type 1 listed
- Lightning counter (option)

Characteristics

Series	MS80	MS100	MS160	MS200
Max. discharge current by phase I _{max}	105 kA	132 kA	192 kA	220 kA
Type of Network				
120/240 Vac Split Phase 3Ph+PE	MS80-120T	MS100-120T	MS160-120T	MS200-120T
120/208 Vac Wye 3Ph/N+PE	MS80-120Y	MS100-120Y	MS160-120Y	MS200-120Y
277/480 Vac Wye 3Ph/N+PE	MS80-277Y	MS100-277Y	MS160-277Y	MS200-277Y
240/415 Vac Wye 3Ph/N+PE	MS80-240Y	MS100-240Y	MS160-240Y	M2S00-240Y
120/120/240 Vac Hi-Leg Delta 3Ph/N PE	MS80-240DCT	MS100-240DCT	MS160-240DCT	MS200-240DCT
240 Vac Delta 3Ph+PE	MS80-240D	MS100-240D	MS160-240D	MS200-240D
347/600 Vac Wye 3Ph/N+PE	MS80-347Y	MS100-347Y	MS160-347Y	MS200-347Y
480 Vac Delta 3Ph+PE	MS80-480D	MS100-480D	MS160-480D	MS200-480D
Protection modes	L/N - L/PE - N/PE - L/L			
Admissible short-circuit current	200 kA			
RFI filtering	- 40 dB			
Standards compliance	UL1449 4th edition - IEC 61643-1			
Safety				
Thermal disconnecter	internal to each component			
Electrical disconnecter	internal to each surge protector			
Failure indicators	by Led			
Failure indicators	audible alarm and remote signaling			
Mechanical characteristics				
Housing material	Metal-NEMA 4, NEMA 12, Stainless steel-NEMA 4X			
Operating temperature	-40/+85 °C			
Mounting	Wall mounting by screws (not supplied)			
Connection to AC network	#10 AWG 36" Leads			
Dimensions (H x L x D)	203 x 152 x 101 mm (8" x 6" x 4")			
Specific features				
Disconnection switch	no			

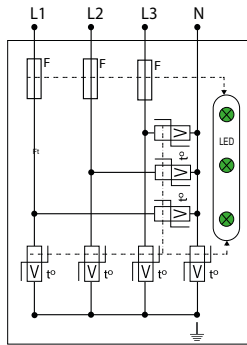
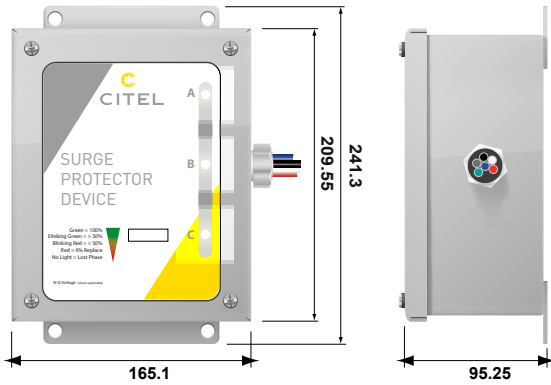

V: High energy varistor
 t° : Thermal disconnecter
 F : Fuse
 LED : Failure indicator

Version	Network	Voltage max. (Uc)	Residual voltage (V) following UL1449@500A			
			L-N	L-PE	N-PE	L-L
MSxxx-120T	120/240 Vac Split Phase 3Ph+PE	150Vac	700	700	700	1000
MSxxx-120Y	120/208 Vac Wye 3Ph/N+PE	150Vac	700	700	700	1000
MSxxx-277Y	277/480 Vac Wye 3Ph/N+PE	320Vac	1000	1200	1000	1800
MSxxx-240Y	240/415 Vac Wye 3Ph/N+PE	320Vac	1000	1200	1000	1800
MSxxx-240DCT	120/120/240 Vac Hi-Leg Delta 3Ph/N PE	150/320vac	1000	1200	1000	1800
MSxxx-240D	240 Vac Delta 3Ph+PE	320Vac	-	1200	-	1800
MSxxx-347Y	347/600 Vac Wye 3Ph/N+PE	550Vac	1800	1800	1800	3000
MSxxx-480D	480 Vac Delta 3Ph+PE	500Vac	-	1800	-	3000

M50 SERIES



M50-120Y-A

- For AC Single Phase and 3-phase network (wye, delta, split phase)
- In: 20 kA
- Imax: 50 kA
- No leakage current
- Visual indicator and audible alarm
- Formats: side or back nipple
- UL 1449 4th Ed. certification

Characteristics

Model	M50-120Y-*	M50-120T-*	M50-120S-*	M50-230S-*	M50-240T-*	M50-240D-*	M50-277Y-*	M50-347Y-*	M50-480D-*	M50-600D-*
System voltage	120-208 V	120-240 V	120 V	230 V	240-480V	240 V	277-480 V	347-600 V	480 V	600 V
AC System	4W+G Wye	3W+G	2W+G	2W+G	3W+G	3W+G Delta	4W+G Wye	4W+G Wye	3W+G Delta	3W+G Delta
Frequency	50 - 60 Hz	50 - 60 Hz	50 - 60 Hz	50 - 60 Hz	50 - 60 Hz	50 - 60 Hz	50 - 60 Hz	50 - 60 Hz	50 - 60 Hz	50 - 60 Hz
Residual current <i>-Leakage current at MCOV</i>	Ipe	None	None	None	None	None	None	None	None	None
Maximum Operating Voltage L- PE	MCOV	140 V	140 V	140 V	270 V	280 V	280 V	320 V	400 V	550 V
Maximum Operating Voltage L- N	MCOV	140 V	140 V	140 V	270 V	280 V	-	320 V	400 V	-
Maximum Operating Voltage N-PE	MCOV	120 V	120 V	120 V	230 V	240 V	-	280 V	350 V	-
Maximum Operating Voltage L-L	MCOV	240 V	280 V	-	-	480 V	280 V	560 V	560 V	690 V
Short Circuit Current Rating	SCCR	200 kA	200 kA	200 kA	200 kA	200 kA	200 kA	200 kA	200 kA	200 kA
Follow current	If	None	None	None	None	None	None	None	None	None
Nominal discharge current <i>15 x 8/20 μs impulses</i>	In	20 kA	20 kA	20 kA	20 kA	20 kA	20 kA	20 kA	20 kA	20 kA
Max. discharge current L-N <i>max. withstand @ 8/20 μs</i>	Imax	50 kA	50 kA	50 kA	50 kA	50 kA	50 kA	50 kA	50 kA	50 kA
Max. discharge current N-PE <i>max. withstand @ 8/20 μs</i>	Imax	100 kA	100 kA	100 kA	100 kA	100 kA	100 kA	100 kA	100 kA	100 kA
Total lightning current <i>max. total withstand @ 8/20 μs</i>	I _{total} [8/20]	100 kA	100 kA	100 kA	100 kA	100 kA	100 kA	100 kA	100 kA	100 kA
Total lightning current <i>max. total withstand @ 10/350 μs</i>	I _{total} [10/350]	15 kA	12 kA	8 kA	8 kA	12 kA	12 kA	15 kA	15 kA	12 kA
Voltage Protection Rating L-PE	VPR	1400 V	1400 V	1400 V	1300 V	1300 V	1400 V	1300 V	2000 V	1300 V
Voltage Protection Rating L-N	VPR	600 V	600 V	600 V	1200 V	1200 V	-	1200 V	2000 V	-
Voltage Protection Rating N-PE	VPR	1300 V	1300 V	1300 V	1300 V	1300 V	-	1300 V	1800 V	-
Voltage Protection Rating L-L	VPR	1100 V	1100 V	-	-	2100 V	1100 V	2100 V	3000 V	2100 V
Associated disconnectors										
Maximum recommended fuse	200 A, Class J									
Thermal disconnector	internal									
Mechanical characteristics										
Dimensions	see diagram									
Visual disconnection indicator	LED off									
Sound disconnection indicator	Continuous Buzzer									
Connection to Network	#12 AWG wires - 24" length									
Operating Temperature	-40/+85 C°									
Housing material	Aluminum cast									
Mounting type	Side or back nipple (Version A or B) T hreaded (M22) - NTP 1/2 adaptor available									
Environmental rating	IP66 / NEMA 6									
Location Installation	Indoor / outdoor									
Standards										
Compliance	IEC 61643-11									
Certification**	UL1449 4th Ed. - File E326289									
Part Number										
for A version (side nipple)	89750101	89750102	89750103	89750303	89750402	89750404	89750501	89750601	89750704	89750804
for B version (back nipple)	89750111	89750112	89750113	89750313	89750412	89750414	89750511	89750611	89750714	89750814

* = A or B

** M50-347Y = UL pending

HARD-WIRE AC SURGE PROTECTOR

M50x-120Y-B

- Output type:
A: side nipple
B: back nipple
- AC network type
- AC voltage network
- F : RFI filter

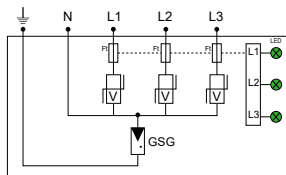
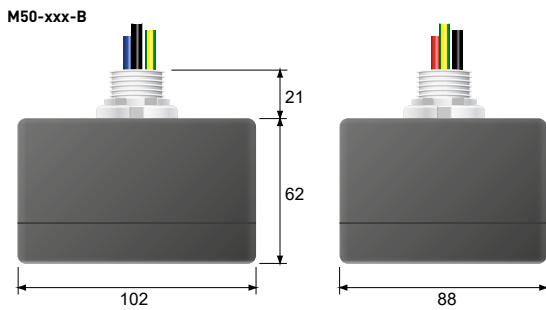
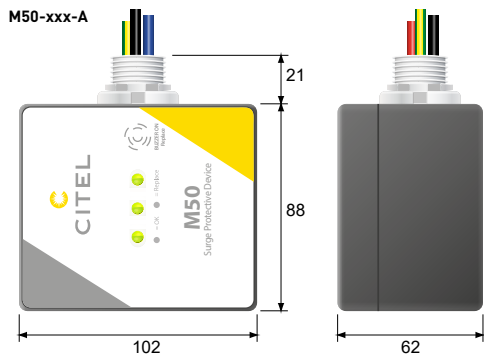

- LED : Disconnection indicator
- Ft : Thermal fuse
- GSG : Specific gas tube
- V: High energy varistor

SERIES MDS



- Type 1 surge protection panels
- Real time diagnostics
- Optional integrated disconnect
- I_{total} : 300kA , 600 kA, 750 kA
- UL1449 4th Ed.



Characteristics

CITEL model	MDS300*				MDS600*				MDS750*				
Suffix	-120T	-240Y	-277Y	-480D	-120T	-240Y	-277Y	-480D	-120T	-240Y	-277Y	-480D	
Network	-120Y	-240D	-347Y	-600D	-120Y	-240D	-347Y	-600D	-120Y	-240D	-347Y	-600D	
Max. operating voltage L-PE	120/240 V	240/415 V	277/480 V	480 V	120/240 V	240/415 V	277/480 V	480 V	120/240 V	240/415 V	277/480 V	480 V	
Temporary Over Voltage (TOV)	120/208 V	240 V	347/600 V	600 V	120/208 V	240 V	347/600 V	600 V	120/208 V	240 V	347/600 V	600 V	
Characteristics	MCOV	150-210 V	300-420 V	420-460 V	550 V	150-210 V	300-420 V	420-460 V	550 V	150-210 V	300-420 V	420-460 V	550 V
Nominal discharge current	Ut	175 Vac	335 Vac	420 Vac	840 Vac	175 Vac	335 Vac	420 Vac	840 Vac	175 Vac	335 Vac	420 Vac	840 Vac
15 impulses 8/20µs	In	20 kA	20 kA	20 kA	20 kA	20 kA	20 kA	20 kA	20 kA	20 kA	20 kA	20 kA	20 kA
8/20µs	I _{total}	300 kA	300 kA	300 kA	300 kA	600 kA	600 kA	600 kA	600 kA	750 kA	750 kA	750 kA	750 kA
1 impulse 10/350µs	I _{imp}	22 kA	22 kA	22 kA	22 kA	44 kA	44 kA	44 kA	44 kA	55 kA	55 kA	55 kA	55 kA
Follow current	I _f	none	none	none	none	none	none	none	none	none	none	none	none
Protection level* at 3 kA + connection	VPR	900	1200	1800	2000	900	1200	1800	2000	900	1200	1800	2000
Protection level * at In	Up	900	1200	1800	2000	900	1200	1800	2000	900	1200	1800	2000
Short-circuit current	SCCR	200 kA	200 kA	200 kA	200 kA	200 kA	200 kA	200 kA	200 kA	200 kA	200 kA	200 kA	200 kA
Associated disconnectors													
Max. recommended fuse	200 A - Classe J												
Thermal disconnector	Included												
Mechanical characteristics													
Dimensions	See diagram												
Connection	screw terminals, mini 4.5 mm ²												
Remote signal indicator	250 Vac max, 2A												
Mounting	Wallmount by screws (not supplied)												
Operating temperature	-50°C/+85°C												
Protection class	NEMA 4 / IP56 / Outdoor												
Housing material	Metal, Stainless steel option												
Standards compliance	NF EN 61643-11 / UL1449 ed.4												
Part number													
	consult us												

* : depends on versions and modes

SPECIFIC AC SURGE PROTECTION PANELS

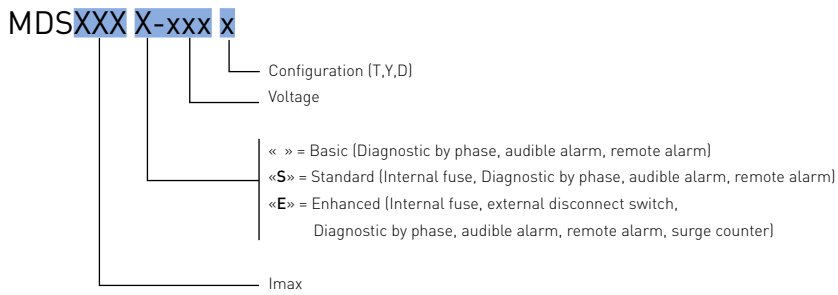

MDS750E series

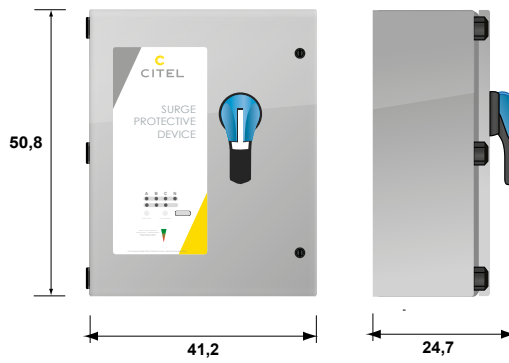

MDS600E series

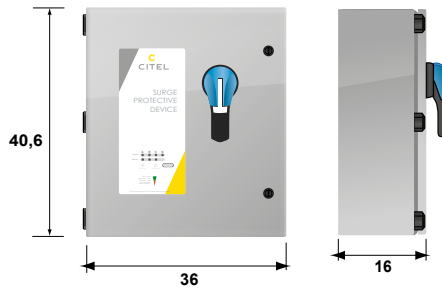

MDS300E series

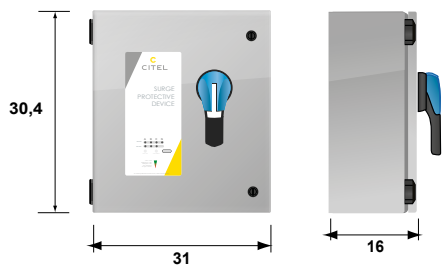



CITEL



LED SYSTEMS
SURGE PROTECTORS

SURGE PROTECTORS FOR LED LIGHTING SYSTEM

LED street lighting is now widely used for its efficiency, its energy cost savings and its life expectancy.

Nevertheless this attractive technology has an important weakness: its sensitivity to transient voltages created by lightning or by power switch operations on AC network.

Due to its scattered and over-exposed location, LED lighting system will face induced surges which will create failure of its power supply, damage LED components or loss of the lighting efficiency. For these reasons, the use of relevant surge protectors located upstream the LED lighting systems is highly recommended.

CITEL offers a full range of surge protectors designed to be installed at different points on the lighting network such as street lights, the base of poles and street cabinets.

CITEL offers solutions adapted to every type of outdoor LED lighting systems : urban, architectural, tunnels etc...



SURGE PROTECTORS FOR LED LIGHTING SYSTEMS

● MLPM and MLPC series

The MLPM and MLPC ranges are compact surge protectors to be installed in small spaces. These devices have a same footprint and are equipped with mechanical (MLPM range) or light (MLPC range) disconnection indicator. MLPM provides spring contact connection whereas MLPC is available in 2 types of connectors (screw terminal or spring) and in two orientations wiring (input / output opposite or input / output on the same side) in order to adapt to the installation as much as possible.











In cases of extreme aggression, these SPDs will switch in failsafe mode : the indication of failure (disconnection) of the surge protector will be provided by an indicator and the switching off the AC power (extinction of the luminaire) will inform the user of the need for maintenance.

● MLP series

MLP range is a complete range of AC surge protectors specifically designed by CITEL for the protection of LED lighting systems at the lantern.

Many versions have been proposed to meet the various existing configurations : surge protection devices are available in different isolation classes (Class I, Class II) and connection type (wire or screw terminal) and equipped with additional protection for data line (RS485, DALI, 0-10V) to provide a complete solution for LED systems with control lines.

In cases of extreme aggression, the surge protector will be in a state of retirement security: according to the different versions available, an indication of the failure of the surge protector is performed by the extinction of an indicator, a AC power disconnection and / or through a remote signalisation.

Series	Description	Characteristics	Page
MLPC MLPC-VG	 Compact Hard-wired surge protector Type 2 (or 3)	Compact. Many configurations	99
MLPC1-230L-V/2L	 Compact Hard-wired surge protector Type 2 (or 3)	Compact, 2-phase+N	102
MLPC1-230L-V/DL	 Combined Hard-wired surge protector Type 2 (or 3)	Compact AC/Data	103
MLPC2/ESP2	 Surge and electrostatic protector	Class II Electrostatic protector	104
MLPM	 Compact Hard-wired surge protector Type 2 (or 3)	Compact. Mechanical indicator	101
MLP	 Hard-wired surge protector Type 2 (or 3)	Remote signaling and Data in option	105
MLPX	 Ultra-compact hard-wired surge protector Type 2 (or 3)	Ultra compact IP67 VG Technology	107
MSB6	 Hard-wired surge protector Type 3	Very Compact. Buzzer indicator	89
DSL DLPM	 DIN surge protector Type 2 (or 3)	Compact. Montage DIN	109 110
DS98L	 DIN surge protector Type 2 (or 3)	Double connector. DIN mounting	111
MLPVM2	 Combined protection for Surge, Temporary and Permanent over-voltages	Class II SPD and POP stages	112

● **MLPX series**

The MLPX range is an compact surge protection solution for installation in tight spaces.

These surge protectors are available with an output by wires and fixing bracket. In the end of life of security the MLPX indicates its failure (disconnection) by the extinction of an indicator and AC power supply switching off (extinction of the luminaire) inform the user of the need for maintenance.

Its IP67 rating makes the MLPX usable in harsh conditions.

● **MSB6 series**

These very compact surge protectors can be integrated in the very small volumes of certain lights (e.g LED strips). The surge protection circuit is equipped with an end of life indicator buzzer in order to indicate the disconnection of the surge protector.

● **DSLIP / DLPM series**

This device is installed inside the bottom of the lighting pole : its very compact dimension allows a easy integration with the connection box, on DIN rail .

DSLIP1 is based on a powerful association of MOV and GDT compo-

nents, secured by thermal disconnecter and disconnection light indicator. The DLPM version offers a mechanical indicator in order to inform about the status of the SPD without voltage supply.

● **DACN10-L series**

The DACN10-L range is a series of AC surge protector for DIN assembly designed to be installed inside boxes at the bottom of poles: its high load current and double output connection allow several LED circuits to be protected. The DACN10-L is based on an efficient combination of a varistor and a gas discharge tube, secured by thermal disconnecter and status indicator.

● **Street cabinet protection**

In order to ensure the real security of the lighting network, the main AC cabinet must also be protected by surge protection devices: surge protectors on the AC network (e.g.: DAC50 range) and, if present, surge protectors on the dataline (e.g.: DLA range).

SURGE PROTECTORS INSTALLATION



MLPC SERIES



- Type 2 (or 3) surge protectors for Led lighting
- Very compact
- Plate mounting
- VG technology version
- Screw terminal or spring terminal connection
- Status indicator
- End of life AC Disconnection
- IEC 61643-11 and EN 61643-11 certification

Characteristics



CITEL Model		MLPC1-230L-*	MLPC-VG1-230L-*	MLPC2-230L-R	MLPC-VG2-230L-*
Description		Surge protector Type2 (or 3) for LED lighting			
Application		Class I LED system	Class I LED system	Class II LED system	Class II LED system
Network		220-240 V single phase	220-240 V single phase	220-240 V single phase	220-240 V single phase
AC system		TT/TN	TT/TN	TT/TN	TT/TN
Protection mode(s)		CM/DM*	CM/DM*	DM*	DM*
Max. AC operating voltage	Uc	320 Vac	320 Vac	320 Vac	320 Vac
Max. Load current	IL	5 A	10 A	5 A	10 A
Residual current - Leakage current at Uc	Ipe	none	none	none	none
Temporary Over Voltage (TOV) Characteristics - 5 sec.	UT	335 Vac withstand	335 Vac withstand	335 Vac withstand	335 Vac withstand
Temporary Over Voltage (TOV) Characteristics - 120 mn	UT	440 Vac disconnection	440 Vac withstand	440 Vac disconnection	440 Vac disconnection
Temporary Over Voltage N/PE (TOV HT)	UT	1200 V/300A/200 ms disconnection	1200 V/300A/200 ms disconnection	-	-
Nominal discharge current - 15 x 8/20 μs impulses	In	5 kA	5 kA	5 kA	5 kA
Max. discharge current - max. withstand @ 8/20 μs by pole	Imax	10 kA	10 kA	10 kA	10 kA
Total discharge current - max. total withstand @ 8/20 μs	Imax total	20 kA	20 kA	20 kA	20 kA
Withstand on Combination waveform - Class III test	Uoc	10 kV	10 kV	10 kV	10 kV
Protection level L/N @In (8/20μs)	Up	1.5 kV	1.5 kV	1.5 kV	1.5 kV
Protection level N/PE @In (8/20μs)	Up	1.5 kV	1.5 kV	-	-
Admissible short-circuit current	Iscrr	10000 A	10000 A	10000 A	10000 A
Associated disconnectors					
Thermal disconnector		internal			
Installation ground fault breaker		Type "S" or delayed			
Mechanical characteristics					
Dimensions		see diagram			
Connection to Network		Screw (2.5 mm ² max) or Spring (1.5 mm ² max) contact terminal		2 spring terminals opposite side in/out - wire 1.5 mm ² max.	Screw (2.5 mm ² max) or Spring (1.5 mm ² max) contact terminal
Voltage/operating indicator		Green Led ON			
Disconnection indicator		Led green OFF and AC network cut-off			
Failsafe behavior		Disconnection and AC network cut-off			
Mounting		on plate			
Operating temperature		-40/+85°C			
Protection rating		IP20			
Housing material		Thermoplastic UL94 V-0			
Standards					
Certification		EN 61643-11 / IEC 61643-11			
Model/Part number					
version Spring contact / 2 opposed terminals		MLPC1-230L-R 831211	MLPC-VG1-230L-R 836211	MLPC2-230L-R 832211	MLPC-VG2-230L-R 837211
version Screw terminal / 2 opposed terminals		MLPC1-230L-V 831221	MLPC-VG1-230L-V 836221	-	MLPC-VG2-230L-V 837221
version Spring contact / 1 common terminal		MLPC1-230L-R/50 831212	-	-	-
version Screw terminal / 1 common terminal		MLPC1-230L-V/50 831222	-	-	-

SURGE PROTECTORS FOR LED LIGHTING SYSTEM

MLPC-VG1-230L-V/50

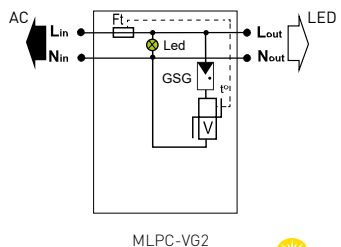
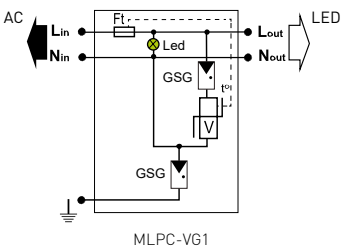
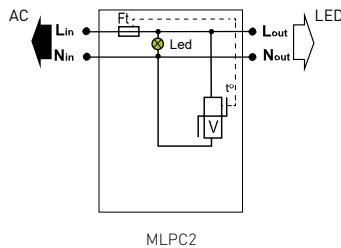
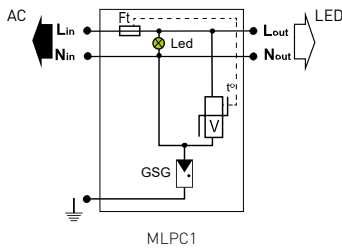
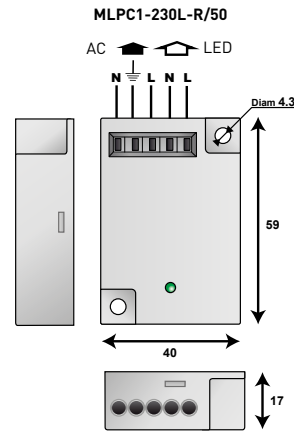
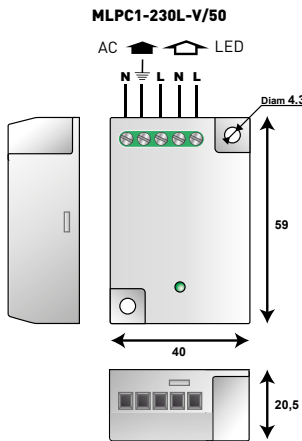
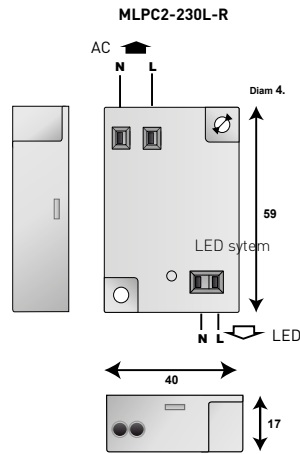
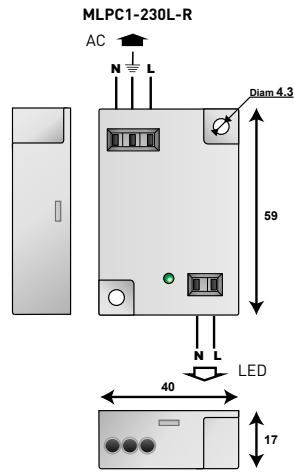
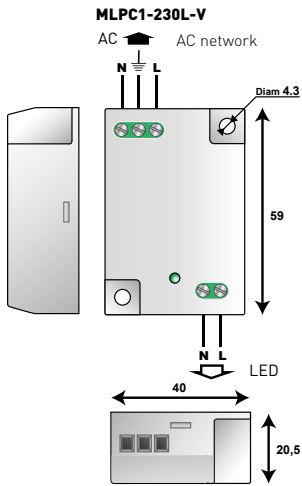
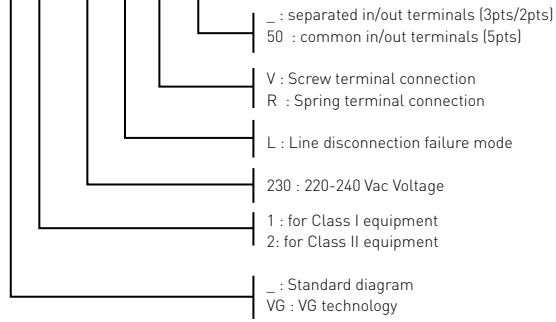

Ft: Thermal fuse
 Led: Disconnection indicator
 V: Varistor
 GSG: Specific Gas Tube
 t°: Thermal disconnection system

MLPM SERIES



MLPM1-230L-R

- Compact Type 2 (or 3) surge protector for 230 Vac networks
- For Class I and Class II
- Spring contact terminal
- Disconnection signaling by mechanical indicator
- AC disconnection in case of end of life
- EN 61643-11, IEC 61643-11 certified

Characteristics

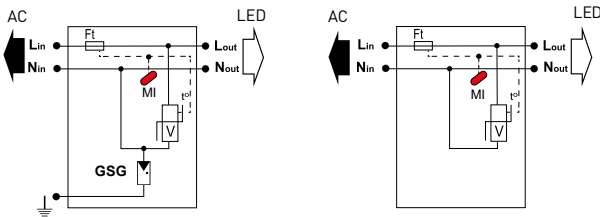
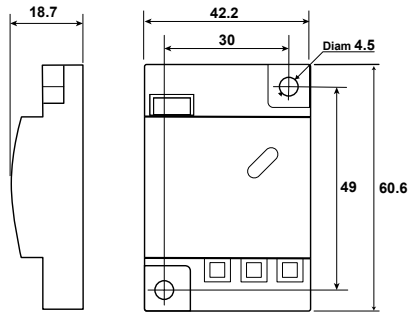

MLPM1-230L-R

MLPM2-230L-R

Ft : Thermal fuse
 MI : Mechanical disconnection indicator
 V : Varistor
 t°: Thermal disconnection system
 GSG : specific Gas tube

CITEL Model	MLPM1-230L-R	MLPM2-230L-R
Description	Compact Type 2 (or 3) hard-wired surge protector	
Application	Class I LED system / Class II LED system	
Network	230-277 V single phase / 230-277 V single phase	
AC system	TT/TN / TT/TN	
Protection model(s)	CM/DM* / DM	
Max. AC operating voltage	Uc	320 Vac / 320 Vac
Max. Load current	IL	10 A / 10 A
Residual current - Leakage current at Uc	Ipe	none / none
Temporary Over Voltage (TOV) Characteristics - 5 sec.	UT	335 Vac withstand / 335 Vac withstand
Temporary Over Voltage (TOV) Characteristics - 120 mn	UT	440 Vac disconnection / 440 Vac disconnection
Temporary Over Voltage N/PE (TOV HT)	UT	1200 V/300A/200 ms disconnection / NA
Nominal discharge current <i>15 x 8/20 µs impulses</i>	In	5 kA / 5 kA
Max. discharge current <i>max. withstand @ 8/20 µs by pole</i>	Imax	10 kA / 10 kA
Total max. discharge current <i>max. total withstand @ 8/20 µs</i>	Imax total	20 kA / NA
Withstand on Combination waveform - Class III test	Uoc	10 kV / 10 kV
Protection level L/N @In (8/20µs)	Up	1.2 kV / 1.2 kV
Protection level N/PE @In (8/20µs)	Up	1.5 kV / -
Admissible short-circuit current	Iscrr	10000 A / 10000 A
Associated disconnectors		
Thermal disconnector	internal	
Installation ground fault breaker	Type «S» or delayed	
Mechanical characteristics		
Dimensions	see diagram	
Connection to Network	Spring terminal - wires : 1.5 mm ² max	
Voltage/operating indicator	Mechanical red indicator OFF	
Disconnection indicator	Mechanical red indicator ON and AC network cut-off	
Failsafe behavior	Disconnection and AC network cut-off	
Mounting	wall or plate	
Operating temperature	-40/+85°C	
Protection rating	IP20	
Housing material	Thermoplastic UL94 V-0	
Standards		
Certification	EN 61643-11 / IEC 61643-11	
Part number		
	841211	842211

MLPC1-230L-V/2L



- Compact Type 2 (or 3) surge protector
- For Classe I
- 2-phases+Neutral network
- Screw connection
- I_{max} : 10 kA
- EN 61643-11, IEC 61643-11 compliance

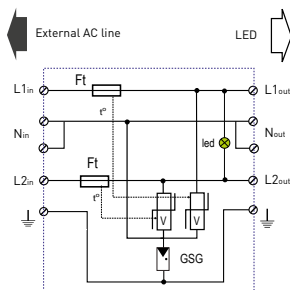
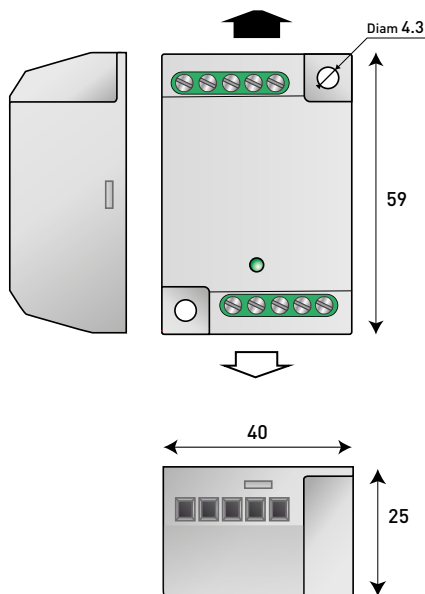

Ft: Thermal fuse
 Led: Disconnection indicator
 V: Varistor
 GSG: Specific Gas Tube
 t°: Thermal disconnection system

Characteristics

CITEL model	MLPC1-230L-V/2L	
Description	AC surge protector for LED lighting	
Application	LED Classe I	
Network	230 V 2-phases+Neutral	
AC system	TT-TN	
Protection model(s)	L1/N, L2/N and N/PE	
Max. AC operating voltage	U _c	320 Vac
Max. load current	I _L	5 A
Residual current - leakage current at U _c	I _{pe}	none
Temporary Over Voltage characteristics (TOV) 5sec.	UT	335 Vac withstand
Temporary Over Voltage characteristics (TOV) 120 mn.	UT	440 Vac disconnection
Nominal discharge current <i>15 x 8/20μs</i>	I _n	5 kA
Maximum discharge current <i>max. withstand 8/20 μs</i>	I _{max}	10 kA
Withstand on combination waveform <i>1,2/50μs-8/20μs</i>	U _{oc}	10 kV / 5 kA
Protection level L/N @In (8/20 μ s)	U _p	1.5 kV
Protection level N/PE @In (8/20 μ s)	U _p	1.5 kV
Admissible short-circuit current	I _{scrr}	10 000 A
Associated disconnectors		
Thermal disconnector	internal	
Mechanical characteristics		
Dimensions	see diagram	
Connection to network	Screw connection: 1,5 mm ² max	
Voltage/operating indicator	Green Led ON	
Failsafe behavior	Disconnection, Green Led OFF and AC line cut-off	
Mounting	on plate	
Operating temperature	-40/+85°C	
Protection rating	IP20	
Housing material	Thermoplastic UL94 V-0	
Standards		
Conforme	EN 61643-11 / IEC 61643-11	
Part number		
	831225	

MLPC1-230L-V/DL



- Type 2 (or 3) surge protector for Class 1 LED lighting
- Combined AC/Dateline surge protection
- DALI, DMX, RS485, 0-10V dataline compliance
- Shield wire management
- Optimized coordination with driver (option: MLPCH1-230L-V/DL)
- Screw connection
- I_{max} : 10 kA
- EN 61643-11, IEC 61643-11 compliance

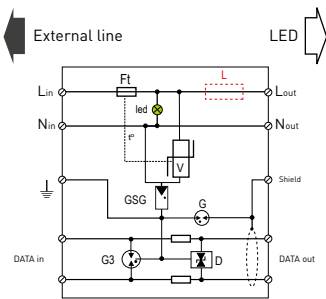
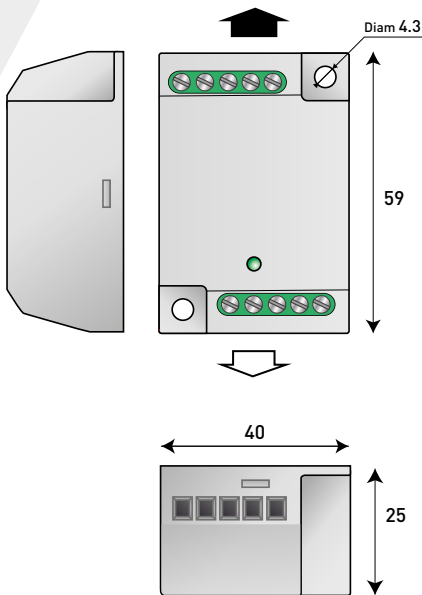

V : Varistor
 Ft : Thermal fuse
 GSG : Specific gas tube
 G : 2-electrode gas tube
 G3 : 3-electrode gas tube
 D : Clamping diode
 L : Coordination inductor (option)
 LED : Status indicator

Characteristics

CITEL model	MLPC1-230L-V/DL
Description	AC/Dateline SPD for LED lighting system Class 1
AC power Characteristic	
Network	230 V single phase
AC system	TT-TN
Protection mode(s)	L/N and N/PE
Max. AC operating voltage	U _c 320 Vac
Max. Load current	IL 5 A (2,5 A)*
Residual current - Leakage current at U _c	I _{pe} None
Temporary over voltage (TOV) characteristics 5sec.	UT 335 Vac withstand
Temporary over voltage (TOV) characteristics 120 mn.	UT 440 Vac disconnection
Nominal discharge current - 15 x 8/20µs impulses	I _n 5 kA
Max. discharge current - max. withstand @ 8/20 µs	I _{max} 10 kA
Withstand on Combination waveform	U _{oc} 10 kV / 5 kA
Protection level L/N @In (8/20µs)	U _p 1.5 kV
Protection level N/PE @In (8/20µs)	U _p 1.5 kV
Admissible short-circuit current	I _{scrr} 10 000 A
Thermal disconnectors	internal
Connection to network	Screw connection : 1,5 mm ² max
Voltage/operating indicator	Green Led ON
Failsafe behavior	Disconnection, Green Led OFF and AC line cut-off
Specific version for optimized coordination with driver	MLPCH1-230L-V/DL*
Dateline Characteristics	
Network	DALI/DMX/RS485/0-10V
Dateline configuration	1-pair + shield
Nominal line voltage	U _n 24 V
Max. DC operating voltage	U _c 28 V
Max. Load current	IL 300 mA
Max. frequency	f max 10 mHz
Insertion loss	< 1 dB
Nominal discharge current - 15 x 8/20µs impulses	I _n 5 kA
Max. discharge current - max withstand @ 8/20µs	I _{max} 10 kA
Protection level L/L or L/PE	U _p 50 V
Protection level Shield/PE	U _p < 600V
Connection to network	Screw connection: 1,5 mm ² max
Failure indication	Transmission cut-off
Mechanical Characteristics	
Dimensions	see diagram
Mounting	on plate
Operating temperature	-40/+85°C
Protection rating	IP20
Housing material	Thermoplastic UL94 V-0
Standards	
Compliance	EN 61643-11 / IEC 61643-11
Part number	
	831225

MLPC2/ESP2 & ESP-230



- Type 2 (or 3) Surge & Electrostatic protectors
- For Class II Led lighting
- Version Electrostatic protector only: ESP-230
- Electrostatic protection included: MLPC2
- Plate mounting
- Screw terminal or spring terminal connection
- Status indicator
- End of life AC Disconnection
- IEC 61643-11 and EN 61643-11 compliance

Characteristics

CITEL Model	MLPC2-230L-V/ESP2	MLPC2-230L-R/ESP2	ESP-230
Description	Surge & Electrostatic protectors for Class II LED lighting		Electrostatic protectors for Class II LED lighting
Network	220-240 V single phase	220-240 V single phase	220-240 V single phase
AC system	TT/TN	TT/TN	TT/TN
Surge Protection mode	L/N	L/N	-
Electrostatic protection mode	N/Functional Earth	N/Functional Earth	N/Functional Earth
Max. AC operating voltage	Uc 320 Vac	320 Vac	320 Vac
Max. Load current	IL 10 A	10 A	-
Residual current leakage current at Uc	Ipe none	none	none
Temporary Over Voltage (TOV) Characteristics - 5 sec.	UT 335 Vac withstand	335 Vac withstand	-
Temporary Over Voltage (TOV) Characteristics - 120 mn	UT 440 Vac disconnection	440 Vac disconnection	-
Nominal discharge current 15 x 8/20 μs impulses	In 5 kA	5 kA	-
Max. discharge current max. withstand @ 8/20 μs by pole	I _{max} 10 kA	10 kA	-
Withstand on Combination waveform - Class III test	Uoc 10 kV	10 kV	10 kV
Protection level L/N @In (8/20μs)	Up 1.5 kV	1.5 kV	-
Electrostatic protection level	UESP > 0.5 kV	> 0.5 kV	> 0.5 kV
Admi. short-circuit current	Iscrr 10000 A	10000 A	-
Associated disconnectors			
Thermal disconnector	internal		
Installation ground fault breaker	Type «S» or delayed		
Mechanical characteristics			
Dimensions	see diagram		
Connection to Network	2 screw terminals opposite side in/out - wire 2.5 mm ² max.	2 spring terminals opposite side in/out Wire 1.5 mm ² max.	2 wires 1 mm ²
Voltage/operating indicator	Green Led ON		
Failsafe behavior	Disconnection and AC network cut-off		
Disconnection indicator	Led green OFF and AC network cut-off		
Mounting	on plate		
Operating temperature	-40/+85°C		
Protection rating	IP20		
Housing material	Thermoplastic UL94 V-0		
Standards			
Compliance	EN 61643-11 / IEC 61643-11		-
Part number			
	832227	832217	354913

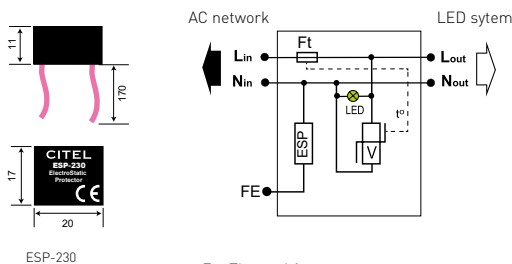
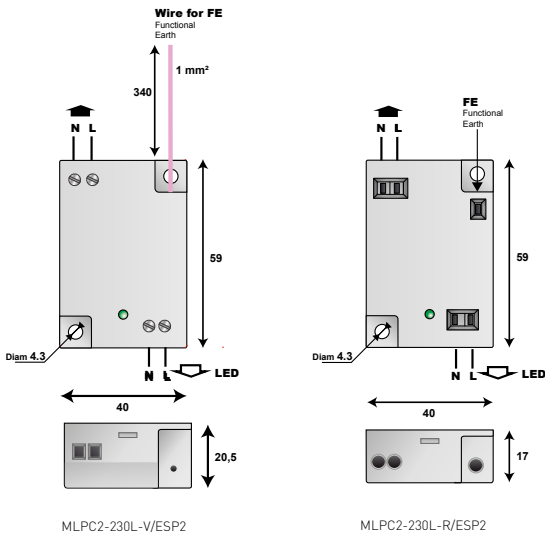

Ft : Thermal fuse
 Led : Status indicator
 V : MOV
 t°: Thermal disconnection system
 ESP: Electrostatic protection
 FE: Functional Earth

COMBINED AC/DATALINE LED LIGHTING SURGE PROTECTOR

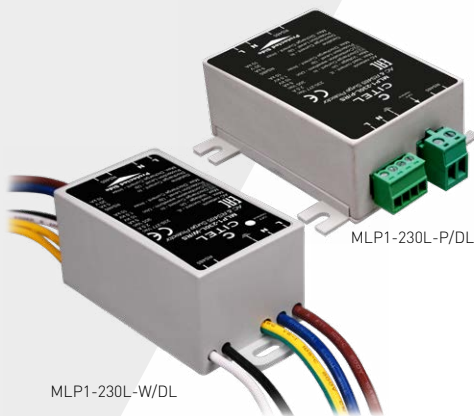

MLP SERIES



- Type 2 (or 3) surge protector
- Combined AC/Dateline version
- Class I or Class II configurations
- IP65 version
- Wire or Screw connection
- Max. discharge current 10 kA
- Remote signaling (option)
- IEC 61643-11 and EN 61643-11 compliance

Characteristics

CITEL Model	MLP1-230L-P/DL	MLP1-230S-W/DL	MLP2-230L-W/DL	MLP2-230S-P/DL
Description	AC/Data SPD for Class I Led lighting system	AC/Data SPD for Class I Led lighting system	AC/Data SPD for Class II Led lighting system	AC/Data SPD for Class II Led lighting system
AC voltage specifications				
Network	220-240 V single phase	220-240 V single phase	220-240 V single phase	220-240 V single phase
AC system	TT-TN	TT-TN	TT-TN	TT-TN
Protection mode(s)	L/N and N/PE	L/N and N/PE	L/N	L/N
Max. AC operating voltage	Uc 305 Vac	305 Vac	305 Vac	305 Vac
Max. Load current	IL 2.5 A	2.5 A	2.5 A	2.5 A
Residual current - Leakage current at Uc	Ipe None	None	-	-
Temporary Over Voltage (TOV) Characteristics - 5 sec.	UT 335 Vac withstand	335 Vac withstand	335 Vac withstand	335 Vac withstand
Temporary Over Voltage (TOV) Characteristics - 120 mn	UT 440 Vac disconnection	440 Vac disconnection	440 Vac disconnection	440 Vac disconnection
Nominal discharge current - 15 x 8/20 μ s impulses	In 5 kA	5 kA	5 kA	5 kA
Max. discharge current -max. withstand @ 8/20 μ s by pole	I _{max} 10 kA	10 kA	10 kA	10 kA
Total lightning current - max. total withstand @ 8/20 μ s	I _{max total} 20 kA	20 kA	-	-
Withstand on Combination waveform - Class III test	Uoc 10 kV	10 kV	10 kV	10 kV
Protection level L/N @In @8/20 μ s	Up 1.5 kV	1.5 kV	1.5 kV	1.5 kV
Protection level N/PE @In @8/20 μ s	Up 1.5 kV	1.5 kV	-	-
Admissible short-circuit current	I _{sc cr} 10000 A	10000 A	10000 A	10000 A
Connection to Network	screw 1.5mm ² max	wire 1.5mm ² max	wire 1.5mm ² max	screw 1.5mm ² max
Voltage/operating indicator	Green Led ON	Green Led ON	Green Led ON	Green Led ON
Failsafe behavior	Disconnection and AC network cut-off	Disconnection	Disconnection and AC network cut-off	Disconnection
Disconnection indicator	Green Led OFF and AC line cut-off	Green Led OFF and remote signaling	Green Led OFF and AC line cut-off	Green Led OFF and remote signaling
Remote signaling of disconnection	none	yes : output on contact NO	none	yes : output on contact NO
Associated disconnectors				
Thermal disconnector	internal			
Installation ground fault breaker	Type "S" or delayed			
Dateline specifications				
Network	DALI/DMX/RS485/0-10V	DALI/DMX/RS485/0-10V	DALI/DMX/RS485/0-10V	DALI/DMX/RS485/0-10V
Nominal line voltage	Un 24 V	24 V	24 V	24 V
Max. DC operating voltage	Uc 28 V	28 V	28 V	28 V
Max. Load current	IL 300mA	300mA	300mA	300mA
Max. frequency	f max 10 MHz	10 MHz	10 MHz	10 MHz
Insertion loss	< 1dB	< 1dB	< 1dB	< 1dB
Nominal discharge current - 15 x 8/20 μ s impulses	In 5 kA	5 kA	100 A	5 kA
Max. discharge current -max. withstand @ 8/20 μ s by pole	I _{max} 10 kA	10 kA	200 A	10 kA
Protection level	Up 50 V	50 V	50 V	50 V
Connection to Network	screw 1 mm ² max	wire 1 mm ² max	wire 1 mm ² max	screw 1 mm ² max
Failure indication	Transmission cut-off	Transmission cut-off	Transmission cut-off	Transmission cut-off
Mechanical characteristics				
Dimensions	see diagram			
Mounting	on plate			
Operating temperature	-40/+85°C			
Protection rating	IP20	IP65	IP65	IP20
Housing material	Thermoplastic UL94 V-0			
Standards compliance	IEC 61643-11 / EN 61643-11 / UL1449 ed.4		IEC 61643-11 / EN 61643-11 / UL1449 ed.4 IEC 61643-21 / EN 61643-21 / UL497A	
Part number	721231	711221	711232	721222

COMBINED AC/DATALINE LED LIGHTING SURGE PROTECTOR

MLP1-230L-W/DL

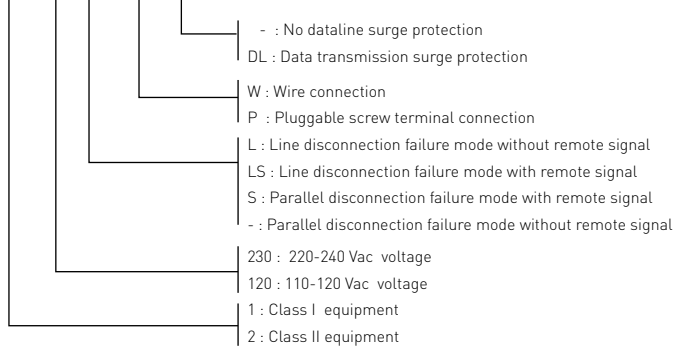

MLP1-xxx-W/xx

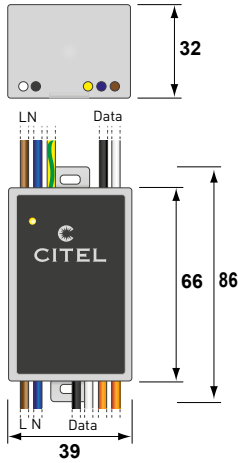

MLP2-xxx-P/xx

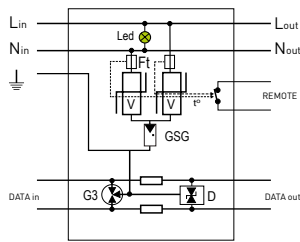
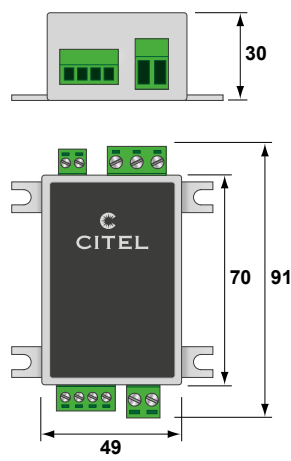

MLP1-230S-W/xx

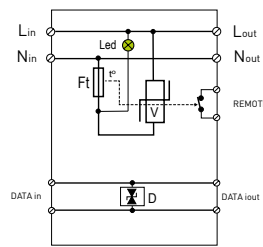

MLP2-230S-P/xx

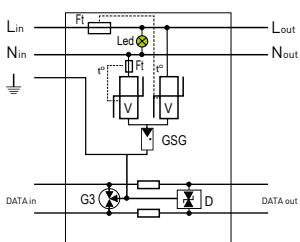

MLP1-230L-W/xx

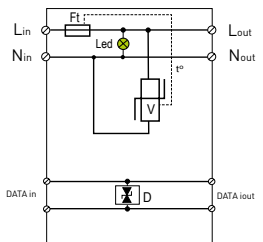

MLP2-230L-P/xx

- Ft : Thermal fuse
- Led : Status indicator
- V : Varistor
- GSG : Specific Gas Tube
- G3 : 3-pole Gas Tube
- D : Clamping diode network
- Remote : Contact for remote signalling
- t° : Thermal disconnection system

HARD-WIRED SINGLE-PHASE TYPE 2 (OR 3) AC SURGE PROTECTOR



MLPX SERIES

- Ultra compact surge protector for 230 Vac networks
- For Class I and Class II
- Breakable mounting bracket
- Protection rating: IP67
- VG Technology (MLPX1VG and MLPX2VG)
- Improved coordination with driver (VG versions)
- Disconnection signaling by indicator
- AC disconnection in case of end of life
- EN 61643-11/IEC 61643-11 certification

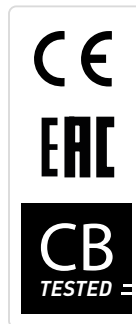

Characteristics

CITEL Model		MLPX1-230L-W	MLPX1VG-230L-W	MLPX2-230L-W	MLPX2VG-230L-W
Description		Compact Type 2 (or 3) hard-wired surge protector			
Application		Class I LED system	Class I LED system	Class II LED system	Class II LED system
Network		220-240 V single phase	220-240 V single phase	220-240 V single phase	220-240 V single phase
AC system		TT/TN	TT/TN	TT/TN	TT/TN
Protection mode(s)		CM/DM	CM/DM	DM	DM
Max. AC operating voltage	Uc	320 Vac	320 Vac	320 Vac	320 Vac
Max. Load current	IL	10 A	10 A	10 A	10 A
Residual current - Leakage current at Uc	Ipe	none	none	none	none
Temporary Over Voltage (TOV) Characteristics - 5 sec.	UT	335 Vac withstand	335 Vac withstand	335 Vac withstand	335 Vac withstand
Temporary Over Voltage (TOV) Characteristics - 120 mn	UT	440 Vac disconnection	440 Vac disconnection	440 Vac disconnection	440 Vac disconnection
Temporary Over Voltage N/PE (TOV HT)	UT	1200 V/300A/200 ms disconnection	1200 V/300A/200 ms disconnection	-	-
Nominal discharge current <i>15 x 8/20 μs impulses</i>	In	5 kA	5 kA	5 kA	5 kA
Max. discharge current <i>max. withstand @ 8/20 μs by pole</i>	I _{max}	10 kA	10 kA	10 kA	10 kA
Total max. discharge current <i>max. total withstand @ 8/20 μs</i>	I _{max total}	20 kA	20 kA	-	-
Withstand on Combination waveform - Class III test	Uoc	10 kV	10 kV	10 kV	10 kV
Protection level L/N @In (8/20μs)	Up	1.5 kV	1.5 kV	1.5 kV	1.5 kV
Protection level N/PE @In (8/20μs)	Up	1.5 kV	1.5 kV	-	-
Admissible short-circuit current	I _{scrr}	10000 A	10000 A	10000 A	10000 A
Associated disconnectors					
Thermal disconnector		internal			
Installation ground fault breaker		Type «S» or delayed			
Mechanical characteristics					
Dimensions		see diagram			
Connection to Network		by wires:1.5 mm ² (L/N) and 2.5 mm ² (PE) by wires:1.5 mm ² (L/N)			
Voltage/operating indicator		Green Led ON			
Disconnection indicator		Led green OFF and AC network cut-off			
Failsafe behavior		Disconnection and AC network cut-off			
Mounting		wall or plate			
Operating temperature		-40/+85°C			
Protection rating		IP67			
Housing material		Thermoplastic UL94 V-0			
Standards					
Certification		EN 61643-11 / IEC 61643-11			
Part number					
		711214	711294	711217	711292

HARD-WIRED SINGLE-PHASE TYPE 2 (OR 3) AC SURGE PROTECTOR

MLPX1VG-230L-W

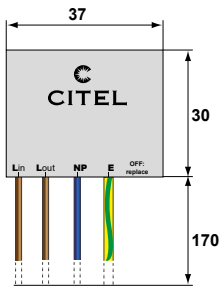
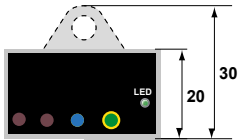
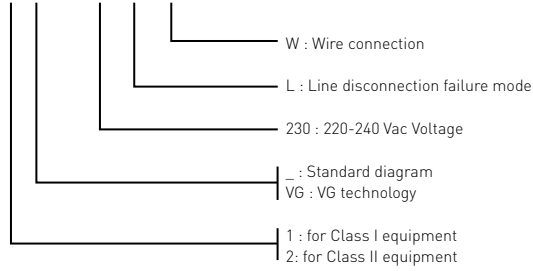

MLPX1-230L-W
MLPX1VG-230L-W

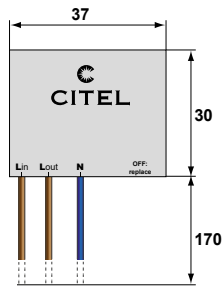
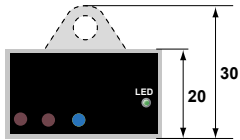

MLPX2-230L-W
MLPX2VG-230L-W

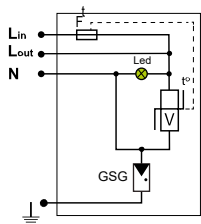

MLPX1

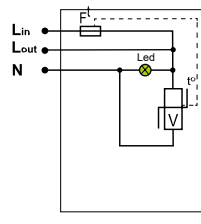

MLPX2

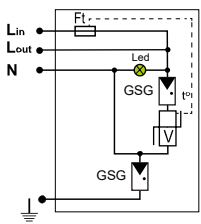

MLPX1VG

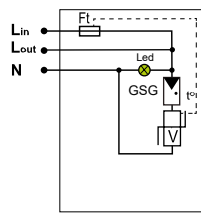

MLPX2VG

V : Varistor
 GSG: Specific gas tube
 Ft : Thermal fuse
 LED : Disconnection indicator
 t° : Thermal disconnection system



DSLSP1-230L

DSLSP SERIES

- Type 2 (or 3) surge protectors for Led
- Very compact (low profile)
- DIN rail mounting
- Screw terminal connection
- Status indicator
- Disconnection AC end of life
- IEC 61643-11 and EN 61643-11 certified

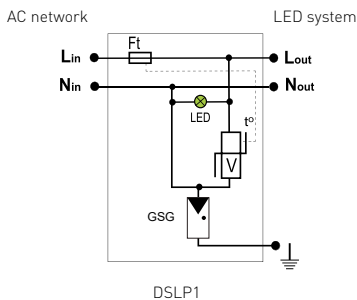
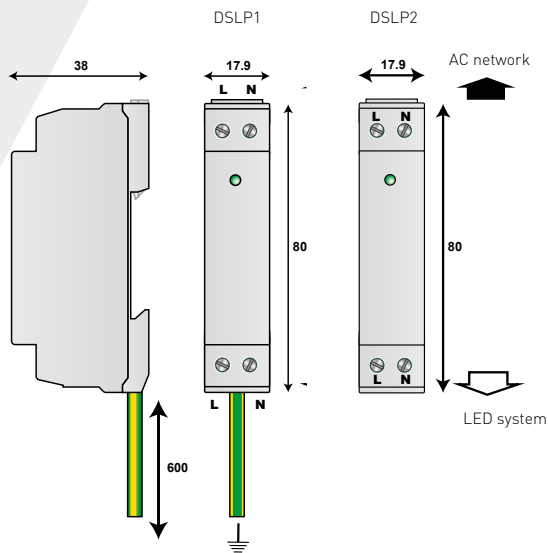

DSLSP1

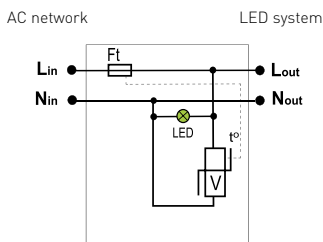

DSLSP2

V: Varistor
 Ft: Thermal fuse
 LED: Disconnection indicator
 t°: Thermal disconnection system
 GSG: Specific Gas Tube

Characteristics

CITEL Model	DSLSP1-230L	DSLSP1-120L	DSLSP2-230L
Description	Surge protectors for LED lighting system		
Application	Class I system	Class I system	Class II system
Network	220-240 V single phase	120 V single phase	220-240 V single phase
AC system	TT/TN	TT/TN	TT/TN
Protection mode(s)	L/N and N/PE	L/N and N/PE	L/N
Max. AC operating voltage	Uc 320 Vac	150 Vac	320 Vac
Max. Load current	IL 10 A	10 A	10 A
Residual current	Ipe none	none	-
Leakage current at Uc	-	-	-
Temporary Over Voltage (TOV) Characteristics - 5 sec.	UT 335 Vac withstand	180 Vac withstand	335 Vac withstand
Temporary Over Voltage (TOV) Characteristics - 120 mn	UT 440 Vac disconnection	230 Vac disconnection	440 Vac disconnection
Temporary Over Voltage N/PE (TOV HT)	UT 1200 V/300A/200 ms disconnection	1200 V/300A/200ms disconnection	-
Nominal discharge current <i>15 x 8/20 μs impulses</i>	In 5 kA	5 kA	5 kA
Max. discharge current <i>max. withstand @ 8/20 μs by pole</i>	Imax 10 kA	10 kA	10 kA
Total discharge current <i>max. total withstand @ 8/20 μs</i>	Imax total 20 kA	20 kA	-
Withstand on Combination waveform - Class III test	Uoc 10 kV	10 kV	10 kV
Protection level L/N @In (8/20μs)	Up 1.5 kV	0.7 kV	1.5 kV
Protection level N/PE @In (8/20μs)	Up 1.5 kV	1.5 kV	-
Admissible short-circuit current	Iscsr 10000 A	10000 A	10000 A
Associated disconnectors			
Thermal disconnector	internal		
Installation ground fault breaker (if any)	«S» type or delayed		
Mechanical characteristics			
Dimensions	see diagram		
Connection to Network	Screw terminal 2.5 mm ² max. Earthing conductor 2 mm ² - 610 cm length		
Voltage/operating indicator	Led green ON		
Disconnection indication	Led green OFF and AC network cut-off		
Failsafe behavior	Disconnection and AC network cut-off		
Mounting	Symmetrical rail 35mm (EN60715)		
Operating temperature	-40/+85°C		
Protection rating	IP20		
Housing material	Thermoplastic UL94 V-0		
Standards			
Certification	EN 61643-11 / IEC 61643-11		
Part number			
	352913	352912	352933



DLPM1-230L

DLPM SERIES

- Type 2 (or 3) surge protectors for Led
- Very compact (low profile)
- Mechanical status indicator
- 15 kA I_{max} version (DLPM1-230L/15K)
- DIN rail mounting
- Screw terminal connection
- Disconnection AC end of life
- IEC 61643-11 and EN 61643-11 certified



Characteristics

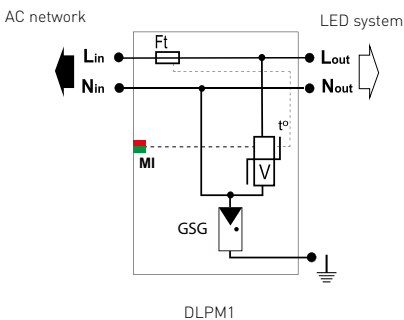
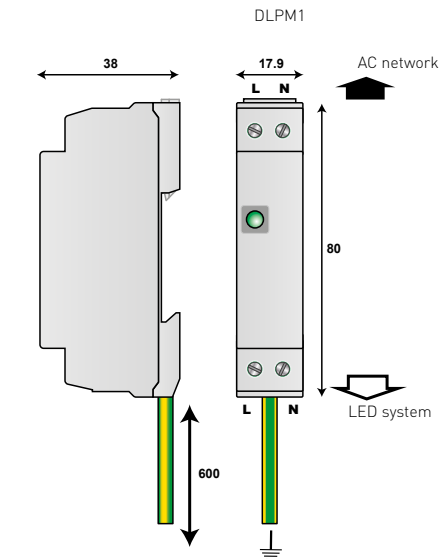

V: Varistor
 Ft: Thermal fuse
 MI: Mechanical disconnection indicator
 t°: Thermal disconnection system
 GSG: Specific Gas Tube

CITEL Model		DLPM1-230L	DLPM1-230L/15K	DLPM2-230L
Description		Surge protectors for LED lighting system		
Application		Class I system	Class I system	Class II system
Network		220-240 V single phase	220-240 V single phase	220-240 V single phase
AC system		TT/TN	TT/TN	TT/TN
Protection mode(s)		L/N and N/PE	L/N and N/PE	L/N
Max. AC operating voltage	Uc	320 Vac	320 Vac	320 Vac
Max. Load current	IL	10 A	10 A	10 A
Residual current	Ipe	none	none	-
Leakage current at Uc				
Temporary Over Voltage (TOV) Characteristics - 5 sec.	UT	335 Vac withstand	335 Vac withstand	335 Vac withstand
Temporary Over Voltage (TOV) Characteristics - 120 mn	UT	440 Vac disconnection	440 Vac disconnection	440 Vac disconnection
Temporary Over Voltage N/PE (TOV HT)	UT	1200V /300A/ 200 ms disconnection	1200V /300A/ 200 ms disconnection	-
Nominal discharge current <i>15 x 8/20 μs impulses</i>	In	5 kA	5 kA	5 kA
Max. discharge current <i>max. withstand @ 8/20 μs by pole</i>	I _{max}	10 kA	15 kA	10 kA
Total discharge current <i>max. total withstand @ 8/20 μs</i>	I _{max total}	20 kA	30 kA	-
Withstand on Combination waveform - Class III test	Uoc	10 kV	10 kV	10 kV
Protection level L/N @In (8/20μs)	Up	1.5 kV	1 kV	1.5 kV
Protection level L/N @In (8/20μs)	Up	1.5 kV	1.5 kV	-
Admissible short-circuit current	I _{scrr}	10000 A	10000 A	10000 A
Associated disconnectors				
Thermal disconnector		internal		
Installation ground fault breaker		Type «S» or delayed		
Mechanical characteristics				
Dimensions		see diagram		
Connection to Network		Screw terminal 2.5 mm ² max. Earthing conductor 2 mm ² length 60 cm		
Voltage/operating indicator		Mechanical indicator green		
Disconnection indicator		Red indicator and AC network cut-off		
Failsafe behavior		Disconnection and AC network cut-off		
Mounting		Symmetrical rail 35mm [EN60715]		
Operating temperature		-40/+85°C		
Protection rating		IP20		
Housing material		Thermoplastic UL94 V-0		
Standards				
Certification		EN 61643-11 / IEC 61643-11		
Part number				
		355913	355973	-



DACN10-L SERIES



- Cost effective single-phase surge protector
- Type 2+3 monobloc compact
- In/Imax: 5 kA/10 kA
- Max. load current: 16A
- Disconnection + AC line cut
- 2-port configuration (series mounting)
- Remote signaling (option)
- EN 61643-11, IEC 61643-11 compliance

Characteristics

CITEL Model		DACN10-L11-150	DACN10-L11-275	DACN10-L21YG-275
Description		Type 2+3, 2-port AC single phase surge protector		
Network		120 Vac	230 Vac	230 Vac
Protection mode		L/N and N/PE	L/N and N/PE	L/N and N/PE
AC system		TT-TN	TT-TN	TN
Max. AC operating voltage	Uc	150 Vac	275 Vac	275 Vac
Temporary Over Voltage (TOV) characteristics - 5 sec.	UT	180 Vac withstand	335 Vac withstand	335 Vac withstand
Temporary Over Voltage (TOV) characteristics - 120ms	UT	230 Vac	440 Vac	440 Vac
Temporary Over Voltage N/PE (TOV HT)	UT	disconnection	disconnection	disconnection
Residual current	Ipe	1200 V/300A/200 ms withstand	1200 V/300A/200 ms withstand	-
Leakage current at Uc		none	none	< 1 mA
Max. Load current	IL	16 A	16 A	16 A
Follow current	If	none	none	none
Nominal discharge current	In	5 kA	5 kA	5 kA
15 x 8/20 μs impulses				
Max. discharge current	Imax	10 kA	10 kA	10 kA
max. withstand @ 8/20 μs by pole				
Withstand on Combination waveform - Class III test	Uoc	10 kV	10 kV	10 kV
Protection level @In (8/20μs)	Up L/N	0,7 kV	1,1 kV	1,3 kV
	Up N/PE	1,5 kV	1,5 kV	1,6 kV
	Up L/PE	-	-	1,6 kV
Admissible short-circuit current	Iscsr	10 000 A	10 000 A	10 000 A
Associated disconnectors				
Thermal disconnector		internal		
Fuses		Fuses type gG - 25 A		
Installation ground fault breaker (if any)		Type «S» or delayed		
Mechanical characteristics				
Dimensions		see diagram, 1TE (DIN43880)		
Connection to Network		by screw terminals: 1.5-10 mm ²		
Failsafe behavior		Disconnection SPD + AC line cut off		
Disconnection indicator		Green LED off		
Remote signaling of disconnection output on NC contact		option	option	option
		DACN10S-L11-150	DACN10S-L11-275	DACN10S-L21YG-275
Max. voltage/current for remote signaling		250 V/0.5 A (AC) / 30 V/2 A (DC)		
Wiring for remote signaling		Max. 1.5 mm ²		
Mounting		Symmetrical rail 35 mm (EN60715)		
Operating temperature		-40/+85°C		
Protection rating		IP20		
Housing material		Thermoplastic UL94 V-0		
Standards				
Compliance		IEC 61643-11 / EN 61643-11 / UL1449 ed.4		
Part number				
		70112011	70112021	70115021

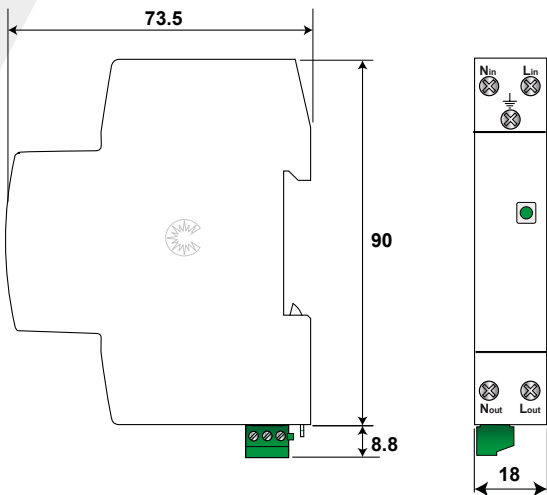

DACN10S-L11-xxx DACN10S-L21YG-275

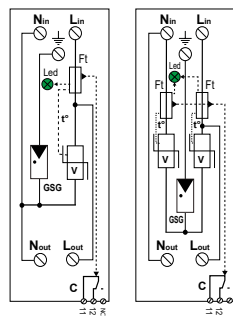

V : Varistor
 GSG : Specific Gas tube
 Ft : Thermal fuse
 t° : Thermal disconnection mechanism
 LED : Disconnector indicator

PROTECTION AGAINST SURGE, TEMPORARY AND PERMANENT OVERVOLTAGES FOR CLASS II LED LIGHTING SYSTEM



MLPVM2-230L-5A



- Protection against all types of overvoltages
- For Class II Led lighting
- 230 V single-phase network / 5 A
- Function «Surge voltage protection» (SPD)
 - Nominal discharge current 8/20µs : 5 kA
- Function «Permanent or temporary Overvoltage Protection» (POP)
 - Overvoltages due to network quality, Neutral failures, wiring mistakes
 - AC overvoltage detection > 270 Vac
 - Automatic reset after defect disappears

Characteristics

CITEL model	MLPVM2-230L-5A	
Description	Protection against Surge, Temporary and Permanent overvoltages	
Isolation class	Class II	
Network	Un	230 V single-phase
Max Load current	IL	5 A
Function «Surge voltage protection»		
Protection mode	L/N	
Max. AC operating voltage	Uc	255 Vac
Nominal discharge current	In	5 kA
Protection level L/N	Up	1.5 kV
Admissible short-circuit current	Iscsr	10000 A
Function «Permanent or temporary overvoltage protection»		
AC overvoltage detection	Udisc	270 Vac
Disconnection time	0.1 ms typical	
Reset time	10 s typical	
Switching capability	L and N cut-off / 5 A @ 250 V	
LED indicator	Green : voltage OK Red : overvoltage (disconnection)	
Mechanical characteristics		
Dimensions	see diagram	
Mounting	on plate	
Connection to network	in series by conductors 1.5 mm ² - spring terminal	
Operating indicator	Led green ON	
Surge protector Failsafe behavior	Disconnection and AC line cut-off	
Surge protector Disconnection indicator	Led green OFF and AC network cut-off	
Operating temperature	-40/+85°C	
Protection rating	IP20	
Housing material	Thermoplastic UL94 V-0	
Part number	832278	

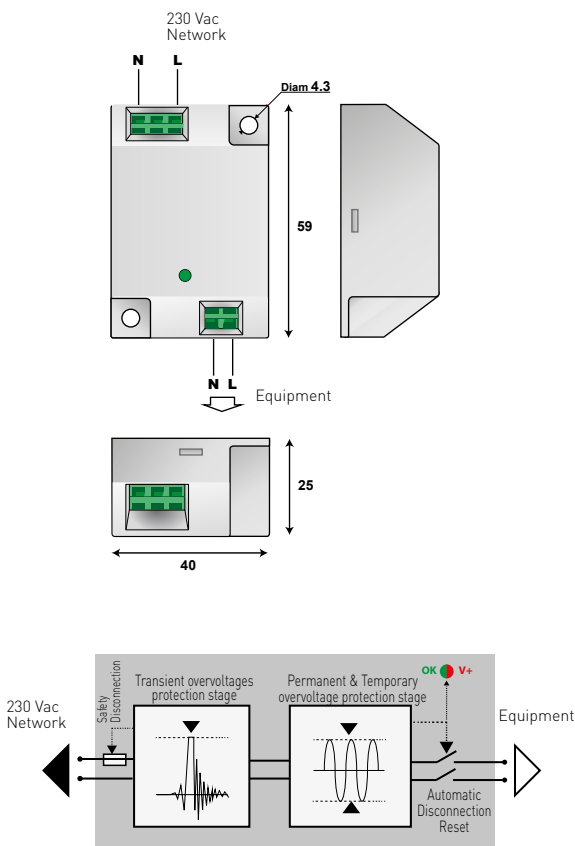



PHOTOVOLTAIC
SURGE PROTECTORS

SURGE PROTECTORS FOR PHOTOVOLTAIC SYSTEMS



Several points must be considered to analyze the risk of lightning and switching surges on PV installations:

- Due to the exposed nature of the PV array, the threat of «lightning» is more common.
- The risk is multiple: direct effect (lightning strike on the panels) and indirect (surge on cells, solar chargers / inverters, on other lines (data)).
- The operating loss must be taken into account, especially at sites of high power capacity.
- When the Photovoltaic system is located on industrial sites, the risk of switching overvoltages must also be taken into account.
- The level of risk is directly related to the lightning density and exposure of local lines

The IEC61643-32 international guide gives the relevant information about the need of protection, the selection and the installation of the surge protective devices.

PROTECTION OF PV INSTALLATION

The photovoltaic grid-connected low voltage power lines may be subject to overvoltages on different networks:

- **AC network:** surge protectors are necessary, and in most cases, mandatory on the AC output of the PV inverter which is connected back to the AC power grid.
- **DC network:** surge protectors are required or mandatory on the input of the PV inverter and, in some conditions, the input of the PV modules.
- **Communication network:** if the PV inverter is connected to signal lines (probes, sensors, monitoring) then surge protectors are highly recommended on these networks.

Most photovoltaic module manufacturers guarantee their materials for 20 years or more. The ROI of photovoltaic generation facilities connected to the low voltage network is therefore calculated over this long period of time. But these systems are often highly exposed to lightning and power surges, which can greatly reduce the required operating time. Implementation of appropriate protection solutions is strongly recommended, and sometime mandatory depending on the local regulations.

AC SURGE PROTECTORS FOR PV INSTALLATION

Depending on the type of networks, the presence of lightning rod or primary surge protectors existing, CITEL offers a complete range of solutions to protect the AC part of the PV system.

Installations with lightning rods

A Type 1 surge protector, specifically dimensioned to handle direct lightning current is required at the service entrance of the installation (main switchboard). Surge protectors like the DAC1-13 provide a high energy surge capacity in a compact size and are easily serviced with pluggable modules.

Standard installation

In the absence of lightning rod, the implementation of a Type 2 SPD is generally preferred, but, in some cases, it is compulsory depending on the level of lightning in the area ($Ng > 2.5$). The DAC50 Type 2 SPD range offers a modular solution adapted to these applications. For medium and small size facilities with limited space available, the DAC40C provides a high surge capacity in a reduced footprint.

Input protection of PV inverter

IEC61643-32 guide requires the implementation of an additional SPD on the AC input of the PV inverter, if it is more than 10 m from the primary surge protector. The DAC15C surge protectors provide this protection for these applications and can be installed either directly into the distribution panel or in a dedicated, standalone enclosure solution.

SURGE PROTECTORS FOR DATALINES

The PV system can be interconnected to various datalines networks including probes, sensors, and monitoring equipment. In these cases, the implementation of suitable surge protectors is highly recommended: The DLA range performs this function and is available for any type of telecom or data line connections

DC SURGE PROTECTORS FOR PV INSTALLATION

CITEL has designed a complete range of Type 1 and Type 2 surge protectors for these applications that are compliant with the IEC61643-31 (or EN50539-11) test standard.

SELECTION OF SURGE PROTECTORS FOR PV POWERLINES

The IEC 61643-31 test standard (or EN 50539-11) defines the SPD parameters and the IEC 61643-32 allows the selection and gives information regarding SPD installation on the DC side of the PV installation.

Main Parameters

Types of SPD

Similar to AC power SPDs, those used on DC power are qualified following types :

- Type 2 SPD: used when direct lightning strike is not taking into account (no LPS). Tested with the parameter I_n (Nominal discharge current $8/20\mu s$).
- Type 1 SPD : must be used in case of possible direct strike (LPS on installation or wide PV farm). Tested with the parameters I_{imp} (10/350 μs Impulse current by pole) and I_{total} (10/350 μs Total Impulse current).
- see «Selection and Location of SPD» table, below

Maximum DC voltage ($U_{c_{pv}}$)

Maximum DC voltage applicable continuously to the SPD. Must be higher than the maximum PV voltage of the installation ($U_{oc_{stc}}$).

Short-circuit current withstand ($I_{sc_{pv}}$).

The surge protector must safely withstand (failsafe disconnection) a end-of-life test on a declared short-circuit current. This $I_{sc_{pv}}$ parameter must be higher than the maximum short-circuit of the PV line ($I_{sc_{stc}}$).

Protection level (Up)

Must be lower than the impulse withstand (U_w) of the equipment of the PV installation (Inverter, PV modules). The IEC61643-32 gives some typical ratings.

Nominal discharge current (I_n)

The repetitive withstand in $8/20\mu s$ current impulse of the Type 2 SPDs must be equal or greater than 5 kA. Higher ratings (15 to 20 kA) gives a longer prospective life duration to the surge protectors.

Impulse current (I_{imp} and I_{total})

The 10/350 impulse withstand on one pole (I_{imp}) or 2 poles together (I_{total}) for Type SPD 1 are related to the installation configuration.

Typical values :

- I_{imp} 5 kA (I_{total} 10 kA) for the installation equipped with LPL III or IV Lightning Protection System or free PV field.
- I_{imp} 10 kA (I_{total} 20 kA) for a PV installation equipped with LPL I Lightning Protection System.

Selecting and locating SPDs on a PV system connected to the AC grid

According to IEC61643-32, the location and type of SPD to be installed on AC and DC networks depend on several criteria (PV on building/PV field, presence of LPS, interconnection, length of lines). The table opposite describes the main configurations.

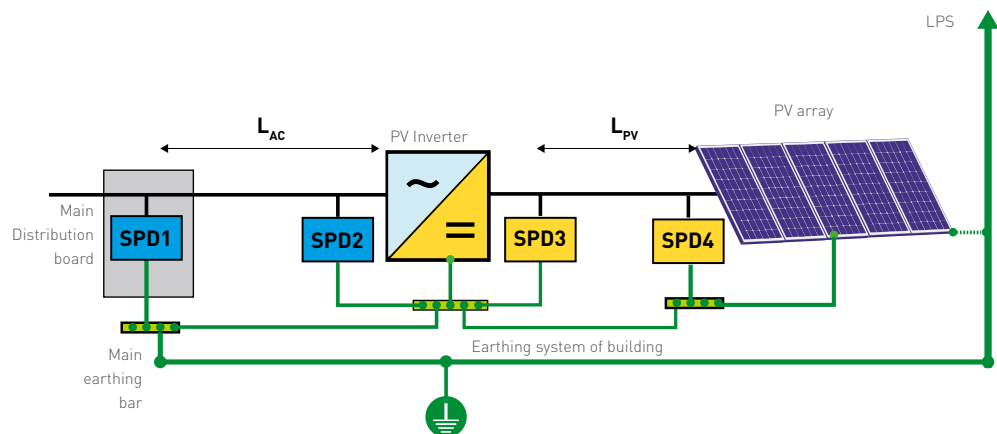

	PV on building equipped with LPS				PV field	PV on building without LPS	
LPS	yes	yes	yes	yes	no	yes	yes
LPS isolated	no	no	yes	yes	-	-	-
PV field	-	-	-	-	yes	-	-
LAC	> 10 m	< 10 m	> 10 m	< 10 m	> 10 m	> 10 m	< 10 m
LPV	> 10 m	< 10 m	> 10 m	< 10 m	> 10 m	> 10 m	< 10 m
SPD1	AC Type 1+2	AC Type 1+2	AC Type 1+2	AC Type 1+2	AC Type 2	AC Type 2	AC Type 2
SPD2	AC Type 1+2	without	AC Type 2	without	AC Type 2	AC Type 2	without
SPD3	PV Type 1	PV Type 1	PV Type 2	PV Type 2	PV Type 1	PV Type 2	PV Type 2
SPD4	PV Type 1	without	PV Type 2	without	PV Type 1	PV Type 2	without

CITEL RANGE FOR PV SURGE PROTECTORS -DIN RAIL MOUNTING



Type 1 surge protectors

When the installation is equipped with lightning rods or for open free PV fields (following IEC61643-32), it is mandatory to install SPD dimensioned for a direct lightning impulse (10/350µs).

- DS60VGPV/51 series:**
 Type 1 SPDs withstand @10/350µs up to 12.5 kA by pole (Iimp) and 25 kA (Itotal).
 With CITEL's exclusive, patented «VG Technology». Comply with IEC61643-31 (and EN50539-12) product test.
- DS50PV/12KT1 and DS50VGPV/12KT1 series:**
 These Type 1 pluggable SPDs have a current total of 12.5 kA (Itotal) and are required when the likely direct current lightning is not maximal or for free PV field.

Type 2 surge protectors

In most installations, the SPD will be necessary or mandatory and will be of type 2. CITEL offers 2 ranges with pluggable module design:

- DS50VGPV/51 series :** This version is based on VG technology, insuring a total absence of leakage current and maximum reliability. Comply with EN50539-11 product test.
- DS50PV/51 series :** based on the use of specific varistors, providing a protection in common mode or differential and common mode. Comply with EN50539-11 product test

CITEL RANGE FOR PV SURGE PROTECTORS - PCB MOUNTING



Surge protector requirements of PV inverter manufacturers have evolved. To save space in the cabinets, the manufacturers have decided to replace DIN rail surge protectors by PCB-mounted SPDs : these ones are designed to be mounted directly inside the inverters, soldered on the internal PCB.

Beyond PV applications, the AC version of these PCB-mounted SPDs could also be used for other applications, where high integration and lower cost are required (i.e charging station for electrical vehicles).

CITEL has developed two dedicated product ranges : PPV (PV power SPD) and PAC (AC power SPD)

PPV range

The PPV range (Type 2 or Type 1 + 2) is designed to protect the DC side of photovoltaic inverters.

The single pole module must be soldered on a PCB, in parallel to the DC network.

Every configuration (Y-diagram, V diagram-circuit, Delta diagram) can be realized, related to the application

The pin-out of the module is the same regardless of the version (T1 or T2) or Ucpv voltage, facilitating the switching from one to the other.

- T1+2 : Iimp = 6,25 kA
- T2 : I_{max} 40 kA or 25 kA
- Remote signaling
- IEC 61643-31 compliance

PAC range

The PAC range (Type 2) is designed to protect the AC side of photovoltaic inverters.

The single pole module must be soldered directly on the PCB, in parallel to the AC network.

The pin-out is the same whatever the U_c voltage.

- U_c: 275, 420 or 680 Vac
- I_{max}: 25 kA or 40 kA
- Remote signaling
- IEC 61643-11 compliance

Application

In order to reach the relevant specifications, the PCB where the PPV or PAC SPDs will be used must be carefully designed by the customer.



DS50PV/51, DS50VGPV/51 and DS50VP/12KT1 series

Pluggable module

Disconnection for simplified maintenance.
Standardized marking



Status signaling

In case of safety disconnection, the indicator switches to red: module to replace.

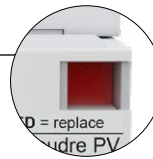

Connectors

Significant physical separation of the screw terminal blocks: ensuring insulation between polarities even for high DC voltages

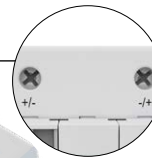

Remote signalling

Option to remotely monitor the status of the surge protector. Simplified cabling thanks to a single terminal for monitoring all poles.

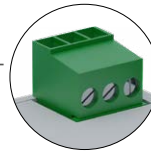

Versions

Type 2: DS50PV/51 et DS50VGPV
Type 1+2: DS50PV/12KT1 and DS50VGPV/12KT1



Earth

Double connector for optimized connection ground network.

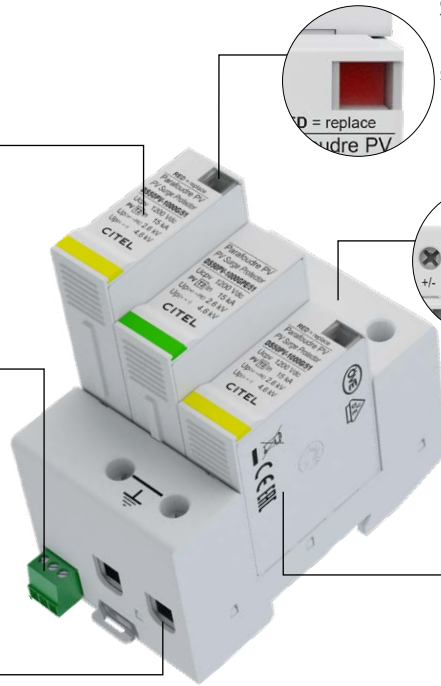

DS60VGPV/51 series



VG Technology

Efficiency and reliability maximum

Connectors

Significant physical separation of the screw terminal blocks: guarantee insulation between polarities even for high DC voltages



Status signaling

In case of safety disconnection, the indicator switches to red: SPD to replace.

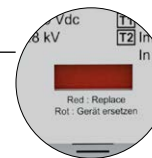

Remote signalling

Standard feature to remotely monitor the status of the surge protector. Simplified cabling thanks to a single terminal for monitoring all poles.

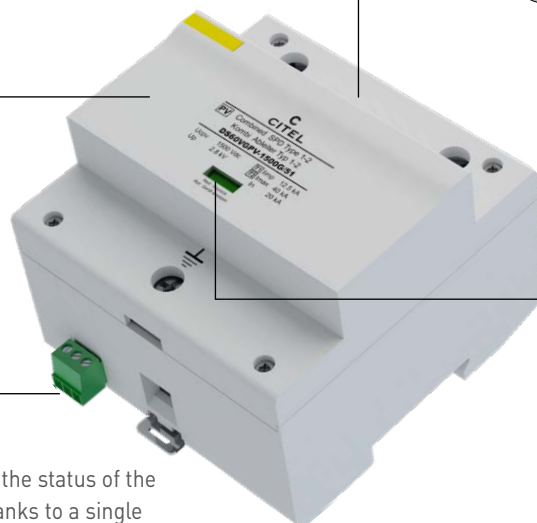

PROTECTION OF ISOLATED (OFF-GRID) PV SYSTEMS

The exposure and location of remote sites powered by isolated PV systems not connected to the AC network are at a very high risk of failure due to transient surges.

Unlike the sites connected to the distribution network, PV equipment failure at a remote site will result in a total operating loss: thus, the implementation of appropriate surge protection is strongly recommended.

The selection and installation of surge protectors for off-grid sites will be defined in the UTE C15-712-2 guide.

PROTECTION OF ISOLATED (OFF-GRID) PV SYSTEMS

CITEL offers a wide range of SPDs dedicated to off-grid PV installations, with extended operating voltages from 12 to 350 Vdc.



DDCxx and DDCxxC are pluggable surge protectors used for DC or PV powerlines. Especially compact, they can easily be installed in off-grid installations.

If the off-grid installation is connected to outdoor equipment, SPDs must also be used on these networks in order to provide a global and efficient protection.

Surge protection for PV powered off-grid installation

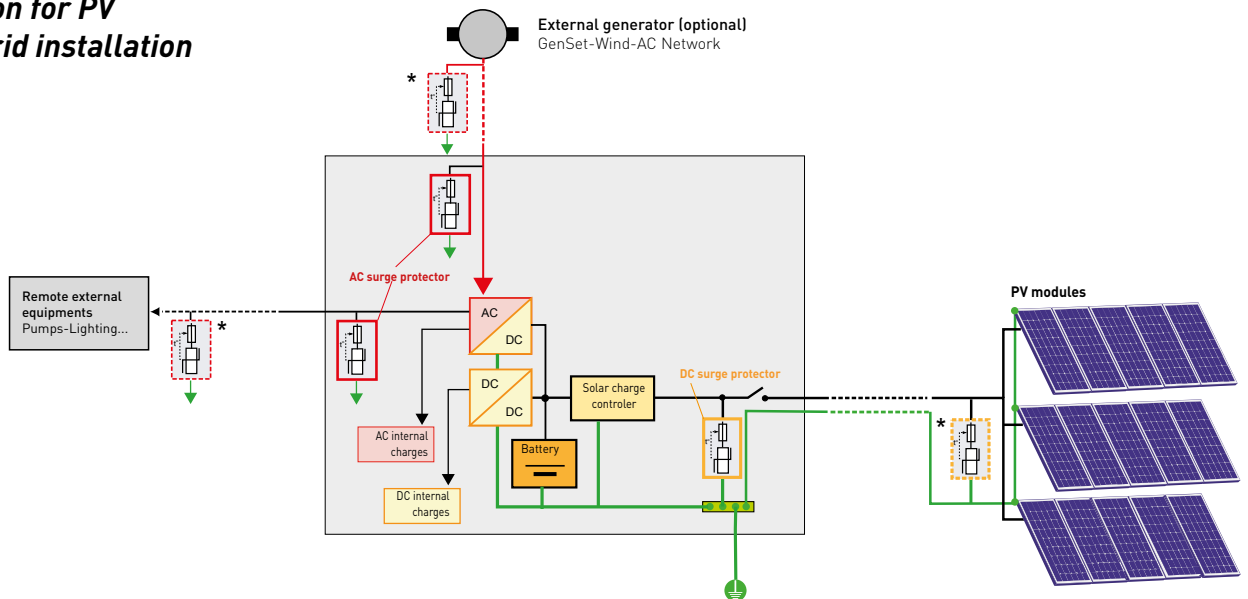

**] Surge protectors at the terminals of the equipment more than 10m away from the facility*

PROTECTION OF PHOTOVOLTAIC INSTALLATIONS

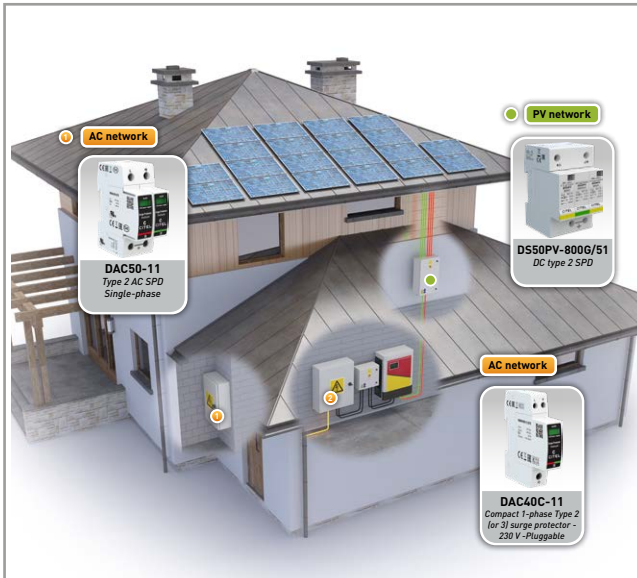

Residential Photovoltaic installation

The IEC61643-32 installation guide gives the relevant information to manage the safe operation of PV installation in case of surge due to lightning. For small power plants (residential and small commercial), AC input (connection to the grid) and DC out should be protected.

The implementation of the SPD may be mandatory for some cases. However, if the reliability and longevity of the PV system are the primary objectives then the implementation of surge protectors is always recommended.



Business/Building Photovoltaic installation

Commercial or industrial sites can integrate very large photovoltaic systems into their power generation strategy. These applications are vulnerable to lightning and transient surges which can cause significant downtime and losses. The implementation of SPDs at key locations throughout the facility is necessary to ensure the reliable operation of the plant. If the building is equipped with LPS, Type 1 SPDs are required on the AC and PV side of the inverter.

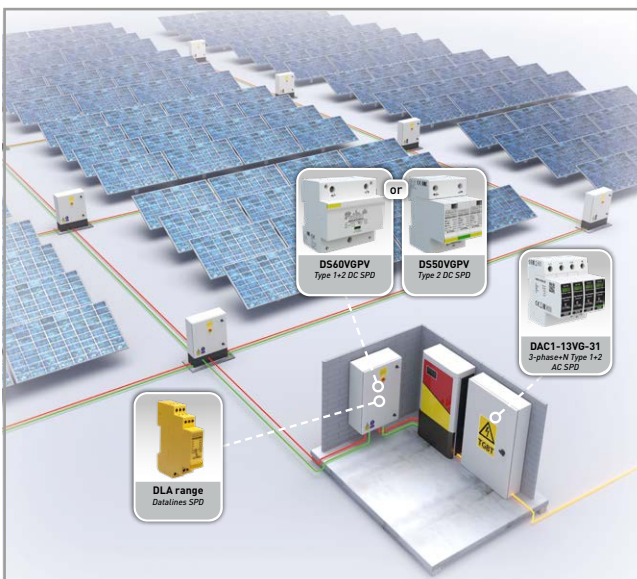

Photovoltaic Power Plant

Photovoltaic power plants have a high risk of lightning strikes due to their large surface area and exposed location. This expensive and sensitive equipment is vulnerable to lightning strikes. It may result in direct replacement costs and operation downtime losses. Thus implementation of SPDs on AC, DC and communication lines are highly recommended.

To comply IEC 61643-32 guide, Type 1 SPDs with a minimum limp rating of 5 kA are required on the DC side of the PV inverter.

TYPE 1+2 PV SURGE PROTECTOR



DS60VGPV-1500G/51



DS60VGPV/51 SERIES

- VG-Technology
- No leakage, no operating currents
- Improved life expectancy
- I_{imp}/I_{total} 12.5 / 25 kA @ 10/350 μ s
- Common and Differential mode protection
- Remote Signaling
- EN 50539-11 compliance
- VDE and OVE approved

DS60VGPV-xxxG/51

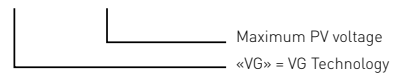

Characteristics

CITEL Model	DS60VGPV-600G/51	DS60VGPV-1000G/51	DS60VGPV-1500G/51
Description	Type 1+2 PV surge protector		
Network	Uocstc 600 Vdc	1000 Vdc	1250 Vdc
Connection mode	+/-/PE	+/-/PE	+/-/PE
Protection mode(s)	CM/DM	CM/DM	CM/DM
Max. PV operating voltage	Ucpv 720 Vdc	1200 Vdc	1500 Vdc
Current withstand short circuit PV	Iscpv 15 000 A	15 000 A	15 000 A
Permanent operating current	Icpv None	None	None
Leakage current at Ucpv			
Residual current	Ipe None	None	None
Leakage current at Ucpv			
Nominal discharge current	In 20 kA	20 kA	20 kA
15 x 8/20 μ s impulses			
Max. discharge current	I _{max} 40 kA	40 kA	40 kA
max. withstand @ 8/20 μ s by pole			
Impulse current by pole	I _{imp} 12.5 kA	12.5 kA	12.5 kA
max. withstand 10/350 μ s			
Total lightning current	I _{total} 25 kA	25 kA	25 kA
max. total withstand @ 10/350 μ s			
Protection level CM/DM	U _p 2.2/2.8 kV	4.7/5.4 kV	4.7/5.4 kV
@ I _n (8/20 μ s) and @ 6kV (1.2/50 μ s)			

Associated disconnectors	
Thermal disconnector	internal
Fuses	without

Mechanical characteristics	
Dimensions	see diagram
Connection to Network	screw terminals: 6-35mm ²
Disconnection indicator	1 mechanical indicator
Remote signaling of disconnection output on changeover contact	250 Vac/0.5 A (AC) - 30 Vdc/3 A (DC)
Mounting	Symmetrical rail 35 mm (EN60715)
Operating temperature	-40/+85°C
Protection rating	IP20
Housing material	Thermoplastic UL94 V-0

Standards	
Compliance	EN50539-11
Certification	EAC VDE / OVE / EAC EAC
Part number	
	3963 3958 3956

*) CM = Common mode (+/PE or -/PE) - DM = Differential mode (+/-)

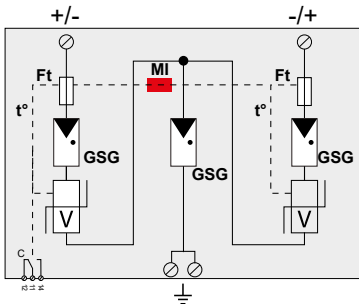
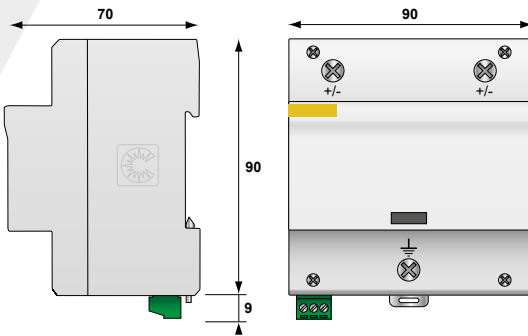

GSG: Specific gas tube
 V: High energy MOV
 MI: Disconnection indicator
 Ft: Thermal fuse
 t°: Thermal disconnection mechanism
 C: Contact for remote signal

TYPE 1+2 PV SURGE PROTECTOR



DS50PVS-1000G/12KT1

D50*PV/12KT1 SERIES

- For 1000 and 1250 Vdc PV voltage
- Impulse currents $I_{imp}/I_{total} : 6.25/12.5 \text{ kA @ } 10/350\mu\text{s}$
- VG-Technology version
- Common Mode and Differential protection
- Remote Signaling (option)
- Plug-in modules
- EN 50539-11 compliance



Characteristics

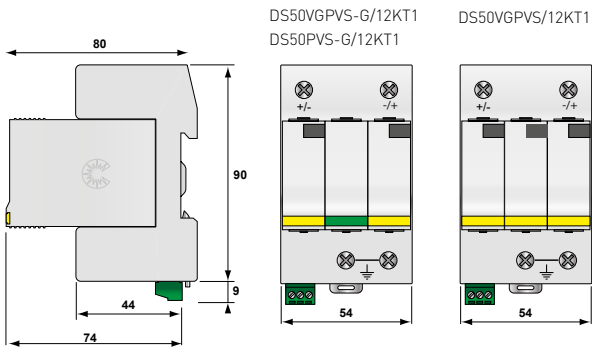

DS50PVS-1000G/12KT1

DS50VGPVS-1000G/12KT1

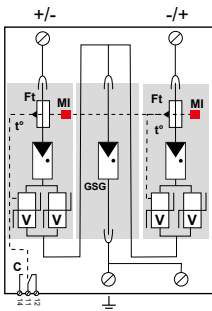
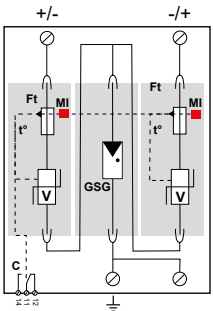

DS50PVS-1500/12KT1

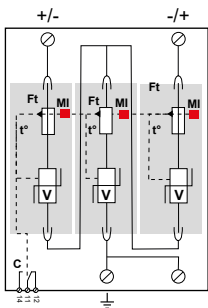

GSG: Gas-filled spark gap
 V : High energy MOV
 Ft : Thermal fuse
 t° : Thermal disconnection mechanism
 C : Contact for remote signal
 MI : Disconnection indicator

CITEL Model	DS50VGPV-1000G/12KT1	DS50PV-1000G/12KT1	DS50PV-1500/12KT1
Description	Type 1+2 PV surge protector		
PV Network	Uocstc 1000 Vdc	1000 Vdc	1250 Vdc
Protection mode(s)	CM/DM	CM/DM	CM/DM
Max. PV operating voltage	Ucpv 1200 Vdc	1200 Vdc	1500 Vdc
Current withstand short circuit PV	Iscpv 15 000 A	15 000 A	15 000 A
Permanent operating current	Icpv None	< 0.1 mA	< 0.1 mA
Leakage current at Ucpv			
Residual current	Ipe None	None	< 0.1 mA
Leakage current at Ucpv			
Follow current	if None	None	None
Nominal discharge current	In 15 kA	15 kA	15 kA
15 x 8/20 μs impulses			
Max. discharge current	I _{max} 40 kA	40 kA	40 kA
max. withstand @ 8/20 μs by pole			
Impulse current by pole	I _{imp} 6.25 kA	6.25 kA	6.25 kA
max. withstand 10/350μs			
Total lightning current	I _{total} 12.5 kA	12.5 kA	12.5 kA
max. total withstand @ 10/350 μs			
Total max. discharge current	I _{max total} 60 kA	60 kA	60 kA
max. total withstand @ 8/20 μs			
Protection level CM/DM	U _p 2.8/5.1 kV	2.6/4.6 kV	5.3/5.3 kV
@In (8/20μs) and @ 6kV (1.2/50μs)			
Associated disconnectors			
Thermal disconnector	internal		
Fuses	without		
Mechanical characteristics			
Dimensions	see diagram		
Connection to Network	Screw terminals: 2.5-25mm ²		
Disconnection indicator	2 mechanical indicators		
Remote signaling of disconnection	Option	Option	Option
output on changeover contact	DS50VGPVS-1000G/12KT1	DS50PVS-1000G/12KT1	DS50PVS-1500/12KT1
Mounting	Symmetrical rail 35 mm (EN60715)		
Operating temperature	-40/+85°C		
Protection rating	IP20		
Housing material	Thermoplastic UL94 V-0		
Standards			
Compliance	EN50539-11		
Certification	EAC	EAC / TUV	EAC / TUV
Part number			
	482303	482383	482523

TYPE 2 PV SURGE PROTECTOR

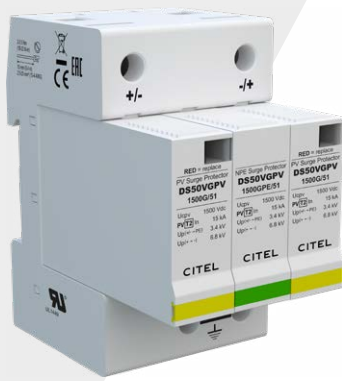

DS50VGPV-1500G/51



DS50VGPV-G/51 SERIES

- VG-Technology
- No leakage current
- Improved life expectancy
- In/Imax : 15/40 kA
- Common Mode/Differential
- Remote Signaling (option)
- EN 50539-11 compliance
- UL, VDE and OVE approved



DS50VGPVS-xxxG/51

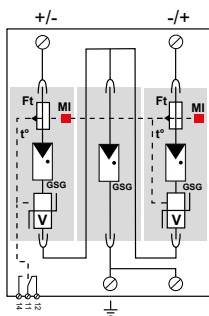
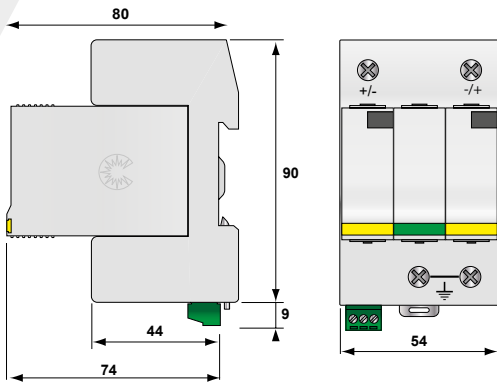
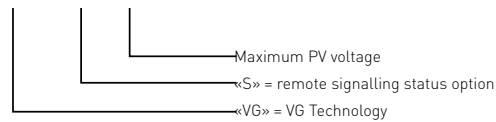

GSG: Specific gas tube
 V : High energy MOV
 Ft : Thermal fuse
 t° : Thermal disconnection mechanism
 C : Contact for remote signal
 MI: Disconnection indicator

Characteristics

CITEL Model		DS50VGPV-600G/51	DS50VGPV-1000G/51	DS50VGPV-1500G/51
Description		Type 2 PV surge protector - Pluggable - VG technology		
PV Network	Uocstc	600 Vdc	1000 Vdc	1250 Vdc
Connection mode		+/-/PE	+/-/PE	+/-/PE
Protection mode(s)		CM/DM	CM/DM	CM/DM
Max. PV operating voltage	Ucpv	720 Vdc	1200 Vdc	1500 Vdc
Current withstand short circuit PV	Iscpv	15 000 A	15 000 A	15 000 A
Permanent operating current	Icpv	None	None	None
Leakage current at Ucpv				
Residual current	Ipe	None	None	None
Leakage current at Ucpv				
Nominal discharge current 15 x 8/20 μs impulses	In	15 kA	15 kA	15 kA
Max. discharge current max. withstand @ 8/20 μs by pole	Imax	40 kA	40 kA	40 kA
Total Maximal discharge current - max. total withstand @ 8/20 μs	Itotal	60 kA	60 kA	60 kA
Protection level CM/DM @In	Up	2.2/3.4 kV	2.8/5.1 kV	3.4/6.8 kV
Associated disconnectors				
Thermal disconnector		internal		
Fuses		without		
Mechanical characteristics				
Dimensions		see diagram		
Connection to Network		Screw terminals: 2.5-25mm ²		
Disconnection indicator		2 mechanical indicators		
Remote signaling of disconnection		Option	Option	Option
output on changeover contact		DS50VGPVS-600G/51	DS50VGPVS-1000G/51	DS50VGPVS-1500G/51
Mounting		Symmetrical rail 35 mm (EN60715)		
Operating temperature		-40/+85°C		
Protection rating		IP20		
Housing material		Thermoplastic UL94 V-0		
Standards				
Compliance		EN50539-11		
Certification		EAC	OVE / EAC	EAC / UL
Part number				
		481401	481301	481501

*) CM = Common mode [+PE or -PE] - DM = Differential mode [+/-]

TYPE 2 PV SURGE PROTECTOR

DS50PV/51 SERIES

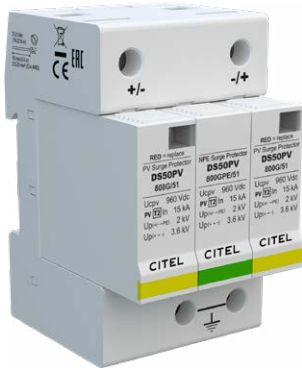

DS50PV-800G/51

- In : 15 kA
- I_{max} : 40 kA
- Pluggable module
- Remote Signaling (option)
- EN 50539-11 compliance
- VDE and OVE approved



DS50PVS-xxxG/51

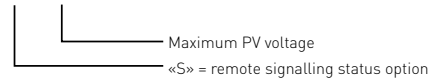

Characteristics

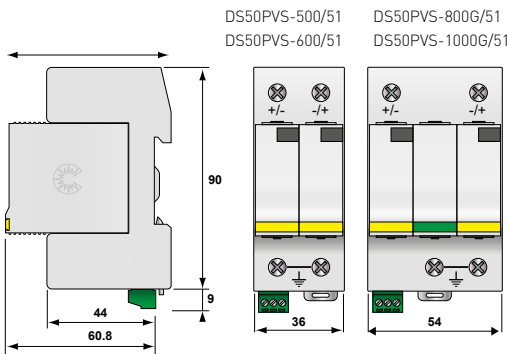

DS50PVS-500/51
DS50PVS-600/51

DS50PVS-800G/51
DS50PVS-1000G/51

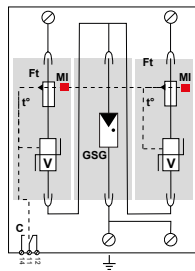
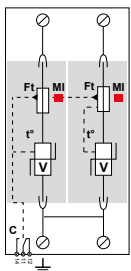

GSG: Specific gas tube
V : High energy MOV
MI : Disconnection indicator
Ft : Thermal fuse
t° : Thermal disconnection mechanism
C : Contact for remote signal

CITEL Model		DS50PV-500/51	DS50PV-600/51	DS50PV-800G/51	DS50PV-1000G/51
Description		Type 2 PV surge protector - Pluggable			
PV Network	Uocstc	500 Vdc	600 Vdc	800 Vdc	1000 Vdc
Connection mode		+/-/PE	+/-/PE	+/-/PE	+/-/PE
Protection mode(s)		CM	CM	CM/DM	CM/DM
Max. PV operating voltage	Ucpv	600 Vdc	720 Vdc	960 Vdc	1200 Vdc
Current withstand short circuit PV	Iscpv	15000 A	15000 A	15000 A	15000 A
Permanent operating current	Icpv	< 0.1 mA	< 0.1 mA	< 0.1 mA	< 0.1 mA
Leakage current at Ucpv					
Residual current	Ipe	< 0.1 mA	< 0.1 mA	None	None
Leakage current at Ucpv					
Nominal discharge current	In	15 kA	15 kA	15 kA	15 kA
15 x 8/20 μs impulses					
Max. discharge current	I _{max}	40 kA	40 kA	40 kA	40 kA
max. withstand @ 8/20 μs by pole					
Total max discharge current	I _{total}	60 kA	60 kA	60 kA	60 kA
- max. total withstand @ 8/20 μs					
Protection level CM/DM @In	Up	2.2 kV	2.8 kV	2 / 3.6 kV	2.6 / 4.6 kV
Associated disconnectors					
Thermal disconnector		internal			
Fuses		without			
Mechanical characteristics					
Dimensions		see diagram			
Connection to Network		Screw terminals: 2.5-25mm ²			
Disconnection indicator		2 mechanical indicators			
Remote signaling of disconnection		Option	Option	Option	Option
output on changeover contact		DS50PVS-500/51	DS50PVS-600/51	DS50PVS-800G/51	DS50PVS-1000G/51
Mounting		Symmetrical rail 35 mm (EN60715)			
Operating temperature		-40/+85°C			
Protection rating		IP20			
Housing material		Thermoplastic UL94 V-0			
Standards					
Compliance		EN50539-11			
Certification		EAC	EAC	EAC	VDE / OVE / EAC
Part number					
		480121	480421	480281	480381

*) CM = Common mode (+/PE or -/PE) - DM = Differential mode (+/-)

TYPE 2 PV SURGE PROTECTOR FOR PCB MOUNTING

PPV SERIES



PPV25S-10-600 PPV40S-10-600 PPV40GS-10-1200

- PCB mounting
- I_{max} : 40 and 25 kA
- Application up to 1500 Vdc PV powerline
- Remote Signaling
- EN 61643-31 and IEC 61643-31 compliance

PPV40S-10-xxxx

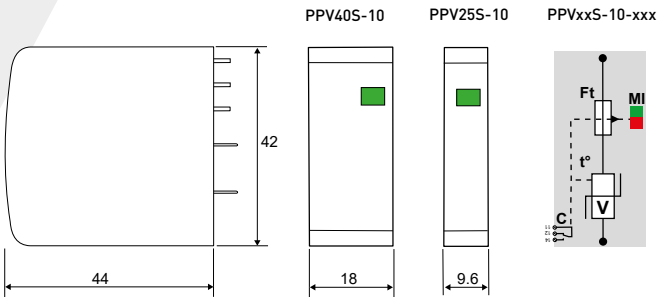
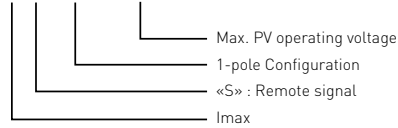

V : High energy MOV
 Ft : Thermal fuse
 t° : Thermal disconnection mechanism
 C : Contact for remote signal
 MI : Disconnection indicator

Characteristics

CITEL Model PPV40S	-	-	PPV40S-10-500	PPV40S-10-600	PPV40S-10-750	PPV40S-10-900	PPV40GS-10-1200*	
CITEL Model PPV25S	PPV25S-10-75	PPV25S-10-300	PPV25S-10-500	PPV25S-10-600	PPV25S-10-750	PPV25S-10-900	-	
Description	Parafoudre photovoltaïque de Type 2							
Technology	MOV	MOV	MOV	MOV	MOV	MOV	GDT	
Max. PV operating voltage	Ucpv 75 Vdc	300 Vdc	500 Vdc	600 Vdc	750 Vdc	900 Vdc	1200 Vdc	
Max. PV operating voltage (star mounting)	Ucpv 150 Vdc	600 Vdc	1000 Vdc	1200 Vdc	1500 Vdc	1800 Vdc	1200 Vdc	
Continuous operating current	Icpv < 0.1 mA	< 0.1 mA	< 0.1 mA	< 0.1 mA	< 0.1 mA	< 0.1 mA	none	
Nominal discharge current 15 x 8/20 μs impulses	In PPV40S series 10 kA	10 kA	20 kA	20 kA	20 kA	20 kA	20 kA	
Max. discharge current max. withstand @ 8/20 μs	I _{max} PPV40S series 25 kA	25 kA	40 kA	40 kA	40 kA	40 kA	40 kA	
Protection level	Up 0,5 kV	1,1 kV	1.8 kV	2 kV	2.6 kV	2.8 kV	2,8 kV	
Protection level (star mounting)	Up 1 kV	2,2 kV	3.6 kV	4 kV	5.2 kV	5.6 kV	2,8 kV	
Current withstand short circuit PV	Iscpv 15 000 A	15 000 A	15 000 A	15 000 A	15 000 A	15 000 A	15 000 A	
Associated disconnectors								
Thermal disconnector	internal							
External Fuses	without							
Mechanical characteristics								
Dimensions	see diagrams							
Connection to Network	through soldering pins							
Disconnection indicator	1 mechanical indicator							
Remote signaling of disconnection	output on changeover contact							
Mounting	on Printed Circuit Board							
Operating temperature	-40/+85°C							
Protection rating	IP20							
Housing material	Thermoplastic UL94 V-0							
Standards								
Compliance	EN 61643-31 / IEC 61643-31							
Part number								
	PPV40S series	-	-	8722202	8722203	8722205	8722206	8722608
	PPV25S series	8721209	8721210	8721202	8721203	8721205	8721206	-

*] ce module est utilisable exclusivement pour la branche de connexion à la terre d'un montage « étoile » pour des tensions Ucpv < 1200 Vdc

PPV1 SERIES



- PCB mounting
- Iimp : 6.25 kA @ 10/350µs
- Application up to 1000 Vdc PV powerline
- Remote Signaling
- EN 61643-31 and IEC 61643-31 compliance

PPV1-6VGS-10-xxx

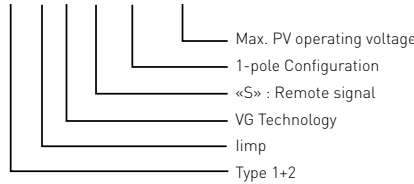

Characteristics

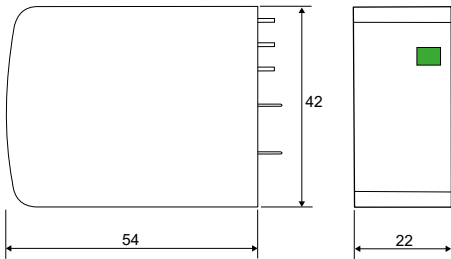

PPV1-6S-10

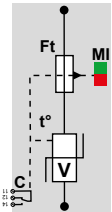

PPV1-6VGS
PPV1-13VGS

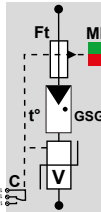

- V : High energy MOV
- GSG: Specific gas tube
- Ft : Thermal fuse
- t° : Thermal disconnection mechanism
- C : Contact for remote signal
- MI : Disconnection indicator

CITEL Model		PPV1-6S-10-600	PPV1-6S-10-750	PPV1-6VGS-600	PPV1-13VGS-10-1200
Description		Type 1+2 PV surge protector			
Max. PV operating voltage	Ucpv	600 Vdc	750 Vdc	600 Vdc	1200 Vdc
Max. PV operating voltage (star mounting)	Ucpv	1200 Vdc	1500 Vdc	1200 Vdc	-
Continuous operating current	Icpv	< 0.1 mA	< 0.1 mA	< 0.1 mA	< 0.1 mA
Nominal discharge current <i>15 x 8/20 µs impulses</i>	In	20 kA	20 kA	20 kA	20 kA
Max. lightning current <i>max. withstand @ 10/350 µs</i>	Iimp	6.25 kA	6.25 kA	6.25 kA	12.5 kA
Protection level	Up	2 kV	2 kV	2 kV	2 kV
Protection level (star mounting)	Up	4 kV	4 kV	4 kV	4 kV
Current withstand short circuit PV	Iscpv	15 000 A	15 000 A	15 000 A	15 000 A
Associated disconnectors					
Thermal disconnector		internal			
External Fuses		without			
Mechanical characteristics					
Dimensions		see diagrams			
Connection to Network		through soldering pins			
Disconnection indicator		1 mechanical indicator			
Remote signaling of disconnection		output on changeover contact			
Mounting		on Printed Circuit Board			
Operating temperature		-40/+85°C			
Protection rating		IP20			
Housing material		Thermoplastic UL94 V-0			
Standards					
Compliance		EN 61643-31 / IEC 61643-31			
Part number					
		8723203	8723205	8723403	8724608

TYPE 2 AC SURGE PROTECTOR FOR PCB MOUNTING

PAC SERIES

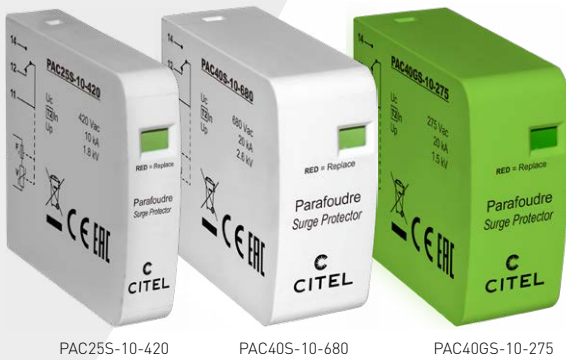

PAC25S-10-420 PAC40S-10-680 PAC40GS-10-275

- PCB mounting
- I_{max} : 40 and 25 kA
- Remote Signaling
- EN 61643-11 and IEC 61643-11 compliance

PAC40S-10-xxxx

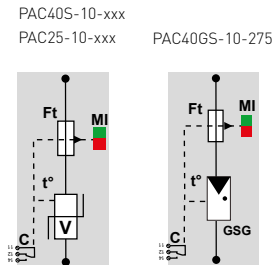
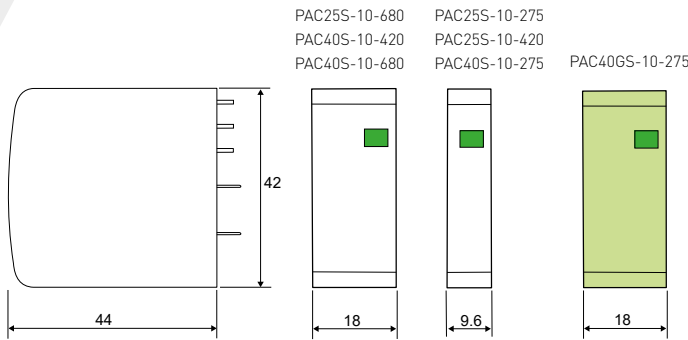
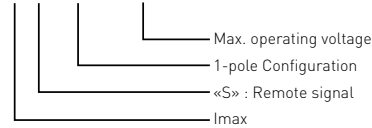

V : High energy MOV
 Ft : Thermal fuse
 t° : Thermal disconnection mechanism
 C : Contact for remote signal
 MI : Disconnection indicator

Characteristics

CITEL Model	PAC25S-10-275	PAC25S-10-420	PAC25S-10-680	PAC40S-10-275	PAC40S-10-420	PAC40S-10-680	PAC40GS-10-275	
Description	1-pole Type 2 AC surge protector							N/PE SPD
Max. operating voltage	Uc 275 Vac	420 Vac	680 Vac	275 Vac	420 Vac	680 Vac	275 Vac	
Residual current	I _{pe} < 0.1 mA	< 0.1 mA	< 0.1 mA	< 0.1 mA	< 0.1 mA	< 0.1 mA	none	
Nominal discharge current <i>15 x 8/20 μs impulses</i>	I _n 10 kA	10 kA	10 kA	20 kA	20 kA	20 kA	20 kA	
Max. discharge current <i>max. withstand @ 8/20 μs</i>	I _{max} 25 kA	25 kA	25 kA	25 kA	40 kA	40 kA	40 kA	
Protection level	U _p 1.1 kV	1.8 kV	2.6 kV	1.1 kV	1.8 kV	2.6 kV	1.5 kV	
Admissible short-circuit current	I _{sc} 25 000 A	25 000 A	25 000 A	25 000 A	25 000 A	25 000 A	25 000 A	
Associated disconnectors								
Thermal disconnector	internal							
External Fuses (if necessary)	50 A gG			125 A gG			-	
Mechanical characteristics								
Dimensions (see diagram)	9.6 mm		18 mm	9.6 mm	18 mm		18 mm	
Connection to Network	through soldering pins							
Disconnection indicator	1 mechanical indicator							
Remote signaling of disconnection	output on changeover contact							
Mounting	on Printed Circuit Board							
Operating temperature	-40/+85°C							
Protection rating	IP20							
Housing material	Thermoplastic UL94 V-0							
Standards								
Compliance	EN 61643-11 / IEC 61643-11							
Part number								
	8711207	8711201	8711204	8712207	8712201	8712204	8712607	

PAC1 SERIES



- PCB mounting
- Remote Signaling
- Iimp : 6.25 kA @ 10/350µs
- EN 61643-11 and IEC 61643-11 compliance
- VG or MOV Technology

PAC1-6VGS-10-xxx

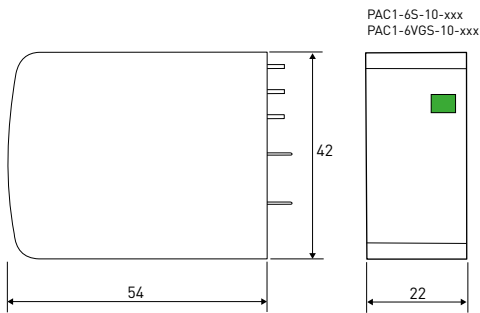
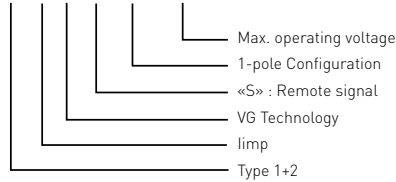

Characteristics

CITEL Model	PAC1-6S-10-275	PAC1-6VGS-10-275
Description	Type 1+2 AC surge protector	
Technology	MOV	VG
Max. operating voltage	Uc 275 Vac	275 Vac
Residual current	Ipe < 0.1 mA	none
Nominal discharge current <i>15 x 8/20 µs impulses</i>	In 20 kA	20 kA
Max. lightning current <i>max. withstand @ 10/350 µs</i>	Iimp 6.25 kA	6.25 kA
Protection level	Up 1.2 kV	1.5 kV
Admissible short circuit current	Iscsr 25 000 A	25 000 A
Associated disconnectors		
Thermal disconnector	internal	
External Fuses (if necessary)	gG type 50 A min/125 A max	
Mechanical characteristics		
Dimensions	see diagram	
Connection to Network	through soldering pins	
Disconnection indicator	1 mechanical indicator	
Remote signaling of disconnection	output on changeover contact	
Mounting	on Printed Circuit Board	
Operating temperature	-40/+85°C	
Protection rating	IP20	
Housing material	Thermoplastic UL94 V-0	
Standards		
Compliance	EN 61643-11 / IEC 61643-11	
Part number		
	8713207	8713407

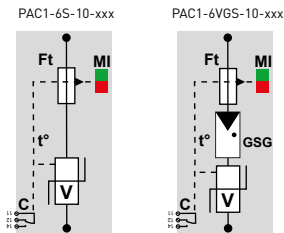

- V : High energy MOV
- GSG: Specific gas tube
- Ft : Thermal fuse
- t° : Thermal disconnection mechanism
- C : Contact for remote signal
- MI : Disconnection indicator

DDCxxC SERIES



DDC20C-20-38

- from 12 to 350 Vdc
- Compact design
- I_{max}: 20 to 40 kA
- Remote signalling (option)
- EN 61643-11, IEC 61643-11 and UL1449 ed.4 compliance

DDCxxCS-20-xxxx

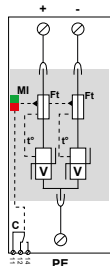
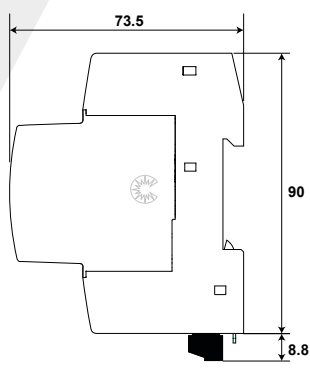
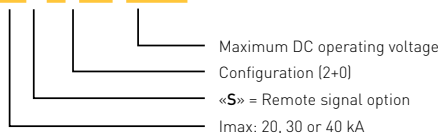

V : High energy MOV
 Mi : Disconnection indicator
 Ft : Thermal fuse
 t° : Thermal disconnection mechanism
 C : Contact for remote signal

Characteristics

CITEL Model	DDC20C-20-24	DDC20C-20-38	DDC30C-20-65	DDC40C-20-100	DDC40C-20-125	DDC40C-20-150	DDC40C-20-180	DDC40C-20-275	DDC40C-20-350	DDC40C-20-460
Network	12Vdc	24Vdc	48 Vdc	75 Vdc	95 Vdc	110 Vdc	130 Vdc	220 Vdc	280 Vdc	350 Vdc
Max. operating voltage PV-DC	U _{cpv} 24 Vdc	38 Vdc	65 Vdc	100 Vdc	125 Vdc	150 Vdc	180 Vdc	275 Vdc	350 Vdc	460 Vdc
Permanent operating current @ U _{cpv}	I _{cpv} < 0.1 mA	< 0.1 mA	< 0.1 mA	< 0.1 mA	< 0.1 mA	< 0.1 mA	< 0.1 mA	< 0.1 mA	< 0.1 mA	< 0.1 mA
Nominal discharge current 15 x 8/20 μs impulses	I _n 10 kA	10 kA	15 kA	20 kA	20 kA	20 kA	20 kA	20 kA	20 kA	20 kA
Max. discharge current max. withstand @ 8/20 μs by pole	I _{max} 20 kA	20 kA	30 kA	40 kA	40 kA	40 kA	40 kA	40 kA	40 kA	40 kA
Protection level +/-PE @ I _n (8/20 μs)	U _p 250 V	250 V	300 V	390 V	450 V	500 V	620 V	900 V	1200 V	1400 V
Protection level +/- @ I (8/20 μs)	U _p 500 V	500 V	600 V	780 V	900 V	1000 V	1200 V	1800 V	2400 V	2800 V
Current withstand short circuit PV	I _{scpv} 1000 A	1000 A	1000 A	1000 A	1000 A	1000 A	1000 A	1000 A	1000 A	1000 A
Remote signaling of disconnection output on changeover contact	Option DDC20CS-20-24	Option DDC20CS-20-38	Option DDC30CS-20-65	Option DDC40CS-20-100	Option DDC40CS-20-125	Option DDC40CS-20-150	Option DDC40CS-20-180	Option DDC40CS-20-275	Option DDC40CS-20-350	Option DDC40CS-20-460
Standards										
Compliance	prIEC61643-41/ UL1449 ed.4									
Part number										
	-	-	-	-	-	-	-	-	-	-



TELECOM & DATA LINE
SURGE PROTECTORS

TELECOM-DATA LINE SURGE PROTECTORS

Telecommunication and data transmission devices (PBX, modems, data terminals etc..) are becoming increasingly vulnerable to lightning-induced voltage surges.

These devices are becoming more complex, sensitive and share a common grounding connection with other networks. This situation increases the risk for these sensitive devices to be stressed by destructive surge voltages, induced by lightning or by electrical switching operations.

Moreover, these devices are nowadays installed at every level of every installation (industrial, commercial and residential buildings), making these possible disturbances unacceptable and/or costly.

To make this telecom or data equipment sufficiently reliable, the installation of a dedicated surge protector, against transient overvoltages, is highly recommended.



SURGE PROTECTORS FOR TELECOM AND DATA LINES

Surge protectors for telecom and data transmission equipment could be divided in 3 types:

- Surge protectors for telecom networks
- Surge protectors for datalines and industrial networks
- Surge protectors for Local Area Networks (LANs)

CITEL products differ by their electrical diagrams and their mechanical configurations, adapted to the need of each type of network.

Reminder:

Devices connected to telecom or data networks, are also connected to the AC distribution network: in order to ensure a coordinated protection, surge protectors must be installed on each inter-connected networks.

TECHNOLOGY OF SURGE PROTECTORS

All CITEL telecom and data line surge protectors are based on reliable multistage hybrid design that combines a high discharge current capacity with fast response time.

All CITEL telephone and data line surge protectors use a combination of a 3-electrode gas discharge tube and fast clamping diodes, in order to provide:

- A nominal discharge current (repeated without destruction) greater than 5 kA @ 8/20 μ s impulse
- An ultrafast response time < 1 ns
- Safety operation in end of life (Fail-safe behavior: end of life Mode 2 following EN 61643-21)
- Low insertion losses to not disturb the transmission signal.
- The systematic use of 3-electrode gas discharge tubes provides optimum protection through simultaneous sparkover.

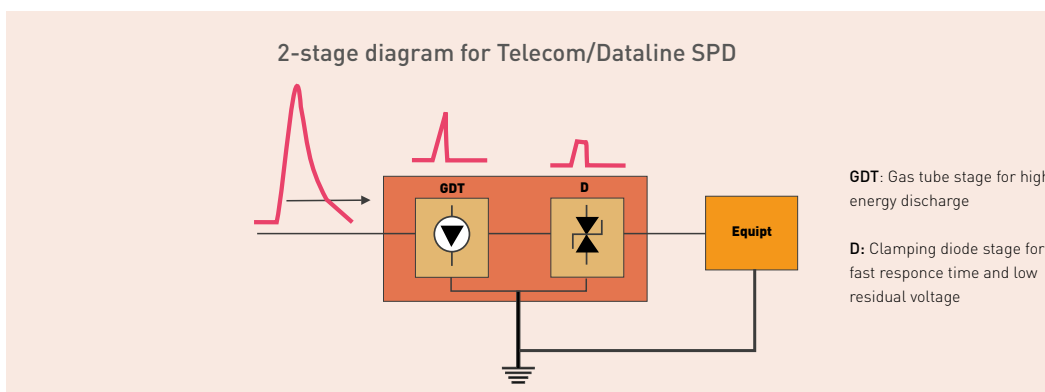

This set of characteristics is essential for optimum reliability of the protected equipment whatever the incident or disturbance.

Various protection diagrams are available according to requirements and the type of network to be protected:

- Standard protection, used mainly for the analog telecom network
- Enhanced protection, for very low voltage transmission lines.
- Line+Shield Protection: Transmission and protection for shield wire.
- «Low capacitance» surge protection for high bit rate links (> 1 Mbit/s)
- Indicator or remote signalling in case of end of life

STANDARDS

Tests procedures and installation recommendations for communication line surge protectors must comply the following international standards:

• **IEC 61643-21:**

Tests of surge protectors for communication lines.

• **IEC 61643-22:**

Choice/installation of surge protectors for communication lines.

Specific tests following EN/IEC 61643-21 standard

Surge protectors for communication lines must be tested following various categories in order to declare their impulse durability:

- **C2 Category:** 10 x 8/20µs current impulses from 1 to 5 kA
- **C3 Category:** 300 x 10/1000µs current impulses from 10 to 100 A
- **D1 Category:** 2 x 10/350µs current impulses from 0.5 to 2.5 kA

As the surge current capabilities of CITEL Telecom/dataline SPDs are very high (typically I_{max} 20 kA), their possible end of life is very unlikely.

Nevertheless, default modes on AC or impulse stress must be tested and declared. 3 default modes are defined by standard:

- **Mode 1:** disconnected SPD but line transmission still active
- **Mode 2:** short-circuited SPD, so line transmission off.
- **Mode 3:** Failed SPD and line transmission off (in-line cutoff).

Typical diagrams for Telecom/Dataline SPD (for 1 pair)

A Standard Protection

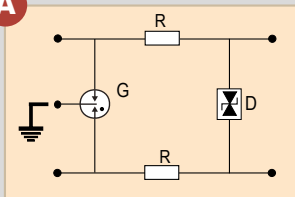

B Reinforced Protection

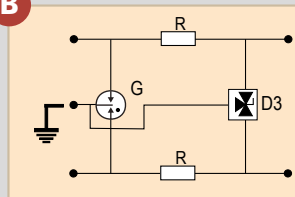

C Low capacitance Protection

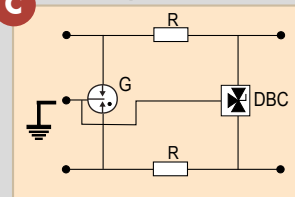

D Protection + Shield

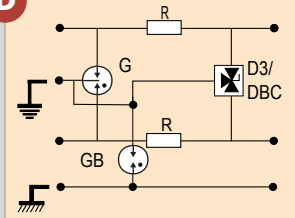

E High bit-rate Protection

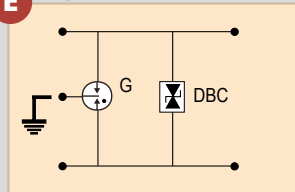

F 3-electrode GDT Protection

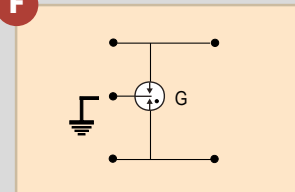

- G: 3-electrode gas tube
- GB: 2-electrode gas tube
- R: Line resistor
- D: Fast Clamping Diode
- D3: 3-pole Clamping Diode
- DBC: Low capacitance clamping diode

TELECOM-DATA LINE SURGE PROTECTORS

USE OF SURGE PROTECTORS

In areas where standards are lacking or non-existent, the decision to use surge protectors on telecom and data lines can be taken by the following:

- The recommendation of the equipment manufacturer
- Corrective action following equipment damage due to transients
- Preventive action following risk assessment (IEC62305-2)
- Preventive action following a simplified risk assessment (below)

Simplified Risk assessment

In order to assess quickly the probability of the lightning surges and their consequences, a simplified risk analysis could be performed following the table below.

Parameters	Low Risk	High Risk
Lightning density (Ng)	< 2,5	> 2,5
Site configuration	Single building	Multiple buildings
Transmission length	Short	Long
External lines distribution	Underground	Overhead
Electrical disturbances	Low	High
Existing lightning rod	No	Yes
Lightning events	Never	Already
Equipment sensitivity	Low	High
Equipment costs	Low	High
Downtime costs	Low or acceptable	Expensive or unacceptable

The level of recommendation (from «no recommendation» to «highly recommended») of using surge protectors increase with the number of parameters classified as «high risk» on the table. More detailed risk analysis are available in the IEC 62305-2 and IEC61643-22 standards.

SURGE PROTECTION PARAMETERS

In choosing surge protection for your installation, bear the following in mind:

- The type of line: There is an appropriate level of protection and protection diagram for each type of line.
- The site configuration: Number of lines to be protected.
- The requested type of installation: The CITEL line provides the following possibilities:
 - Installation in wall-mounted box, plug mounting, on distribution frame
 - various types of connection (screw, spring contact, connectors...)
- Maintenance features: Some surge protectors are:
 - equipped with pluggable modules (DLA).
 - equipped with failure indicators (DLAS1-DLATS1)

INSTALLATION

To be effective, surge protectors must be installed in accordance with the following principles:

- The earth point of the surge protector and of the protected equipment must be interconnected.
- The protection is installed on the network entrance, to divert impulse currents as fast as possible.
- The protected equipment must be nearby (protector/equipment distance less than 10 m long). If this rule cannot be followed, «secondary» protection must be installed near the equipment (coordinated surge protection).
- The grounding conductor (between the earth output of the SPD and the installation bonding circuit) must be as short as possible (less than 0.50 m) and have a minimum cross-section of 1 mm².
- The earth resistance must comply with the standards in force (no special earthing requested).
- Protected and unprotected cables must be kept well apart to limit coupling.

MAINTENANCE

CITEL data line surge protectors require usually no maintenance or replacement. They are designed to withstand repeated and heavy impulse currents without damage.

Nevertheless a controlled fail-safe mode (short circuit to earth) is planned in case of surges exceeding the parameters of the surge protectors:

Protective short-circuit occurs in the following cases:

- Prolonged contact with a AC power line (AC overstress test in accordance with EN 61643-21)
- Exceptionally violent «lightning» strike (impulse overstress test in accordance with EN 61643-21).

In these cases, the surge protector definitively short-circuits, which indicates to the user the functional destruction through a transmission cut, while protecting the terminal equipment (Mode 2 default in accordance with EN 61643-21). The specific versions DLAS1 or DLATS1 provide a different failure mode: opening the line and switching an indicator in the front face of SPD or closing a switch for remote signalling (mode 2 default).

In all these cases, to reactive the line, the user must replace the surge protector or replace the removable module for pluggable versions.

The basic parameters of the surge protector for datalines could be controlled with dedicated testers.

SPECIAL CONDITION: LIGHTNING ROD

If the installation to be protected is equipped with LPS (lightning rod), the surge protectors for telecom or datalines, connected on external lines must be able to conduct 10/350 µs surge current with a rating up to 2.5 kA minimum (D1 category test in IEC 61643-21 standard).



TELECOM SURGE PROTECTORS

PROTECTING TELECOMMUNICATION EQUIPMENT

Telecom devices (PBX, Modems, Terminals..) are especially exposed to lightning surges. CITELE offers a range of surge protectors dedicated to the protecting of these types of telecommunication networks:

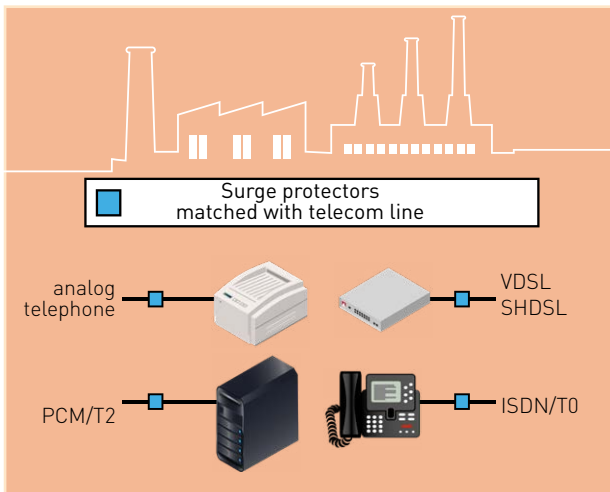

For each type of telecom line, an adapted protection scheme must be used:

Lines	Voltage		Diagram
	Nominal	Residual	
Switched telephone /ADSL	170 V	210 V	Standard protection
ISDN, T0 primary access	48 V	70 V	Enhanced protection
ISDN, T2 primary access	6 V	25 V	Enhanced Protection Low capacitance
VDSL, SHDSL	170 V	210 V	Enhanced protection Low capacitance

The decision whether or not to use surge protection would be determined by taking a simplified risk assessment (see «Risk analysis» paragraph), or by detailed risk assessment (as the one included in IEC 61643-22 standard), or by specific installation conditions as:

Conditions	Recommendation
External telecom lines	Systematic protection
Lines downstream PBX	Protection in long or inter-building lines
Existing AC surge protector	Systematic protection

CITELE RANGE

Surge protectors for telecom networks are designed to fit into existing installations. So, CITELE surge protectors are available with several mechanical configurations and different mounting options:

- Connection boxes for Wall Mounting
- RJ11/RJ45 connection modules
- DIN rail mounting enclosure

B180 - B280 - B480 	Wall mounting Screw connection 1 to 4 pairs
MJ6 - MJ8 	RJ11 or RJ45 1 to 4 pairs
DLC - DLA - DLU 	DIN mounting Screw or spring connection 1 or 2 pairs Pluggable (option)

DATA LINE SURGE PROTECTORS

PROTECTING INDUSTRIAL NETWORKS

Industrial installations, businesses or smart buildings are packed with an increasing quantity of control equipment, measurement, control and supervisory equipment.

These systems are built with controller cards, probes, sensors and various sensitive electronic components: downtime on the operation on this equipment can be extremely costly.

Thus, it is increasingly vital to guarantee a relevant level of reliability to these systems: this can be obtained by installing data-line surge protection.

Equipment to be protected

Industrial or business installations are equipped with many different types of sensitive terminals, which must be protected against transient voltages, such as:

- Industrial process equipment
- SCADA systems (Supervisory Control And Data Acquisition)
- Transmission systems
- I/O cards
- Interfaces, converters
- Probes
- Actuators
- Access control system
- Fire detection system, Displays

Many data transmissions (or fieldbus) exist on the market. The table beside provides some examples of relevant CITEL surge protector model (DLA series: pluggable module, or DLC series: monobloc & compact module) in relation to the type of data transmission.

Network	Wiring	DLC	DLA*
4-20 mA	1 pair	DLC-24D3	DLA-24D3
Profibus-FMS	1 pair+Shield	DLC-12D3	DLA-12D3
Profibus-PA	1 pair+Shield	DLC-48D3	DLA-48D3
Profibus-DP	1 pair+Shield	DLC-12DBC	DLA-12DBC
Interbus	1 pair+Shield	DLC-12D3	DLA-12D3
Foundation Fieldbus-H1	1 pair+Shield	DLC-12D3	DLA-12D3
Foundation Fieldbus-H2	1 pair+Shield	DLC-48DBC	DLA-48DBC
WorldFIP	1 pair+Shield	DLC-48DBC	DLA-48DBC
Fipway	1 pair+Shield	DLC-48DBC	DLA-48DBC
LONworks	1 pair+Shield	DLC-48DBC	DLA-12DBC
Batibus	1 pair+Shield	DLC-12D3	DLA-12D3
RS485	1 pair+Shield	DLC-12D3	DLA-12D3
RS422	2 pairs	-	DLA2-06D3
RS232	4 wires	-	DLA2-12D3

DATA LINE SURGE PROTECTORS



CITEL RANGE

CITEL surge protectors for industrial data networks are designed to fit on symmetrical DIN rail.

Due to multiple possible configurations requested, CITEL offers a large range of solutions, the surge protectors are available in various configurations:

- Number of protected wires: 1 to 2 pairs.
- Screw or spring contact wiring
- Transmission and protection of the shield wire
- Compactness (DLC)
- Plug-in modules: Fixed version [DLU, DLU2] or Version with removable module [DLA, DLA2] to ease the maintenance process.
- Signalling or remote signalling feature in case of end of life [DLAS1, DLATS1]
- Higher load current

The summary table below informs the different features related to the different models of dataline SPDs for DIN mounting.

DLA - DLA2 - DLAS1 - DLATS1		Pluggable 1 or 2 pairs Screw/spring connection Imax 20 kA
DLU - DLU2		Monobloc 1 or 2 pairs Screw connection Imax 20 kA
DLC		Compact Monobloc 1 pair Spring connection Imax 10 kA

CITEL range	Line configuration	Pluggable Module	Line transmission when plug-out	Default mode (following IEC61643-21)	Shield management	Wire Connection	Default Signalling	Default Remote Signalling	Width	Imax	Max Load current
DLA	1 pair	Y	On	Mode 2	Y	screw	N	N	13 mm	20 kA	0.3 A
DLA/R	1 pair	Y	On	Mode 2	Y	spring	N	N	13 mm	20 kA	0.3 A
DLAW	1 pair	Y	Off	Mode 2	Y	screw	N	N	13 mm	20 kA	0.3 A
DLAW/R	1 pair	Y	Off	Mode 2	Y	spring	N	N	13 mm	20 kA	0.3 A
DLAHW/R	1 pair	Y	Off	Mode 2	Y	spring	N	N	13 mm	20 kA	2.4 A
DLAH	1 pair	Y	On	Mode 2	Y	screw	N	N	13 mm	20 kA	2.4 A
DLAH/R	1 pair	Y	On	Mode 2	Y	spring	N	N	13 mm	20 kA	2.4 A
DLA2	2 pairs	Y	On	Mode 2	Y	screw	N	N	18 mm	20 kA	0.3 A
DLA-IS	1 pair + 0V	Y	On	Mode 2	Y	screw	N	N	18 mm	20 kA	2.4 A
DLAS1	1 pair	Y	On	Mode 2	Y	screw	Y	N	18 mm	20 kA	0.3 A
DLAS1/R	1 pair	Y	On	Mode 2	Y	spring	Y	N	18 mm	20 kA	0.3 A
DLAWS1	1 pair	Y	Off	Mode 2	Y	screw	Y	N	18 mm	20 kA	0.3 A
DLAWS1/R	1 pair	Y	Off	Mode 2	Y	spring	Y	N	18 mm	20 kA	0.3 A
DLATS1	1 pair	Y	On	Mode 2	Y	screw	Y	Y	18 mm	20 kA	0.3 A
DLATS1/R	1 pair	Y	On	Mode 2	Y	spring	Y	Y	18 mm	20 kA	0.3 A
DLAWTS1	1 pair	Y	Off	Mode 2	Y	screw	Y	Y	18 mm	20 kA	0.3 A
DLAWTS1/R	1 pair	Y	Off	Mode 2	Y	spring	Y	Y	18 mm	20 kA	0.3 A
DLC	1 pair	N	NA	Mode 2	N	spring	N	N	6 mm	10 kA	0.3 A
DLU	1 pair	N	NA	Mode 2	Y	screw	N	N	18 mm	20 kA	0.3 A
DLU2	2 pairs	N	NA	Mode 2	N	screw	N	N	18 mm	20 kA	0.3 A
DLUH	1 pair	N	NA	Mode 2	Y	screw	N	N	18 mm	20 kA	2.4 A
DLUH2	2 pairs	N	NA	Mode 2	N	screw	N	N	18 mm	20 kA	2.4 A

DLA SERIES



- Pluggable surge protection for «DIN» mounting
- All types of Telephone and Data lines
- Shield wire protection
- Screw (DLA) or spring contact (DLA/R) terminals
- Without line cut-off (DLA) or with (DLAW)
- IEC 61643-21 compliance
- UL497A approved

Characteristics

CITEL Model	DLA-170G	DLA-170	DLA-48DBC	DLA-48D3	DLA-24D3	DLA-12D3	DLA-06DBC	DLA-06D3	
Description	Telecom/Data SPD- 1-pair DIN mounting - Pluggable								
Network	Telephone line, ADSL2, VDSL2, SHDSL	Telephone line, ADSL2, VDSL	Fipway, WorldFIP, FieldBus-h2	ISDN-T0, 48 V line	4-20 mA	RS232, RS485	E1/T2 line 10BaseT	RS422	
SPD configuration	1-pair+shield	1-pair+shield	1-pair+shield	1-pair+shield	1-pair+shield	1-pair+shield	1-pair+shield	1-pair+shield	
Nominal line voltage	Un 150 V	150 V	48 V	48 V	24 V	12 V	6 V	6 V	
Max. DC operating voltage	Uc 170 V	170 V	53 V	53 V	28 V	15 V	8 V	8 V	
Max. Load current	IL 300 mA	300 mA	300 mA	300 mA	300 mA	300 mA	300 mA	300 mA	
Max. frequency	f max > 100 MHz	> 10 MHz	> 20 MHz	> 3 MHz	> 3 MHz	> 3 MHz	> 20 MHz	> 3 MHz	
Insertion loss @ fmax	< 1 dB	< 1 dB	< 1 dB	< 1 dB	< 1 dB	< 1 dB	< 1 dB	< 1 dB	
Nominal discharge current 8/20µs Test x 10 - C2 Category	In 5 kA	5 kA	5 kA	5 kA	5 kA	5 kA	5 kA	5 kA	
Max. discharge current max. withstand @ 8/20 µs by pole	Imax 20 kA	20 kA	20 kA	20 kA	20 kA	20 kA	20 kA	20 kA	
Impulse current 2 x 10/350µs Test - D1 Category	Iimp 5 kA	5 kA	5 kA	5 kA	5 kA	5 kA	5 kA	5 kA	
Protection level following C3 Category test	Up 750 V	220 V	75 V	70 V	40 V	30 V	25 V	20 V	
Failsafe behavior	Short-circuit	Short-circuit	Short-circuit	Short-circuit	Short-circuit	Short-circuit	Short-circuit	Short-circuit	
Mechanical characteristics									
Dimensions	see diagram								
Format	Plug-in DIN box								
Connection to Network	DLA-xxx: screw terminal - cross section 0.4-1.5 mm ² DLA-xxx/R: spring terminal - cross section 0.4-1.5 mm ²								
Disconnection indicator	transmission interrupt - Default Mode 2								
Mounting	Symmetrical rail 35 mm (EN60715)								
Operating temperature	-40/+85°C								
Protection rating	IP20								
Housing material	Thermoplastic UL94 V-0								
Spare module	DLAM-170G	DLAM-170	DLAM-48DBC	DLAM-48D3	DLAM-24D3	DLAM-12D3	DLAM-06DBC	DLAM-06D3	
Versions	DLA-xxx: standard version (line continuity in case of removal of plug-in module) - screw terminal DLA-xxx/R: standard version with spring contact terminal DLAW-xxx: specific version with line cut-off in case of removal plug-in module. DLAH-xxx: «remote supply» version with max. line current IL = 2,4 A DLA-PE: grounding version								
Standards									
Compliance	IEC 61643-21 / EN 61643-21 / UL497A								
Part number									
DLA range	640165	6406011	640421	6403021	6403011	6402011	640121	6401011	
DLA/R range	-	6401054	6404214	6403024	6401034	6402014	6401214	6401014	
DLAH range	-	641005	641014	641004	641003	641002	641011	641001	
DLAW range	-	640805	-	640804	640803	640802	640811	640801	

DIN RAIL PLUG-IN SURGE PROTECTOR FOR DATALINE/TELECOM

DLA-**xxx** / **W** / **H**

- Wiring: « » [Screw] or «R» [Spring]
- Bit rate [D3 or DBC]
- Nominal voltage
- « »: standard diagram
- «W»: line cut-off if removal plug-in module
- «H»: max. line current IL: 2.4 A

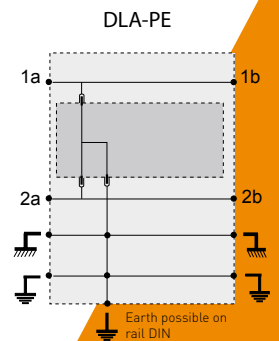
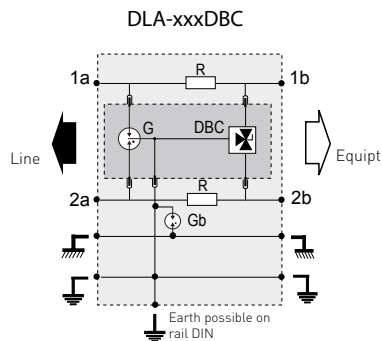
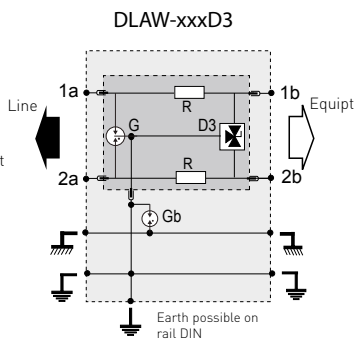
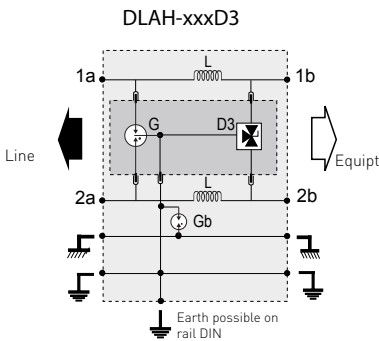
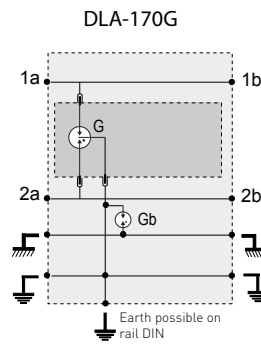
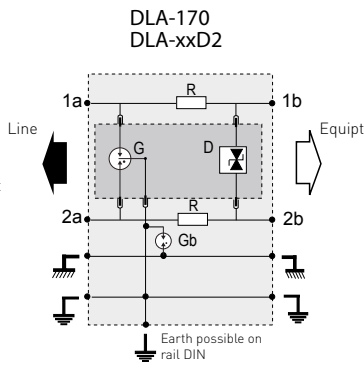
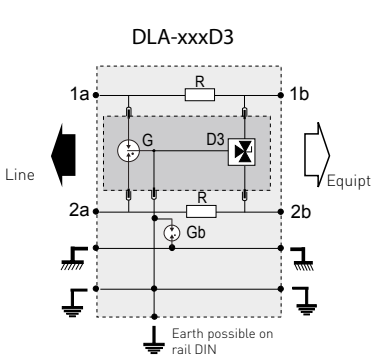
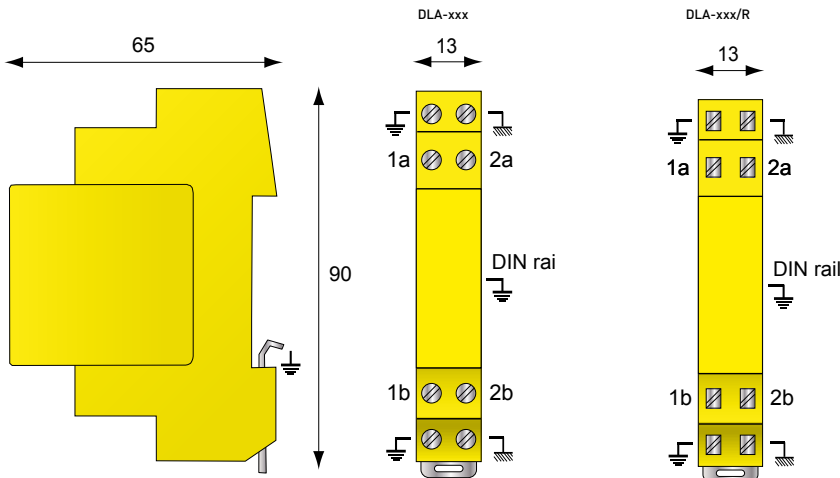

G: 3-electrode gas tube
 Gb: 2-electrode gas tube
 R: Resistor
 D: Clamping diode

DLA2 SERIES



DLA2-24D3

- Pluggable surge protection for «DIN» mounting
- 2-pair surge protection
- All type of telecom and data lines
- Shield wire protection
- IEC 61643-21 compliance
- UL497 A approved

Characteristics

CITEL Model		DLA2-170	DLA2-48DBC	DLA2-48D3	DLA2-24D3	DLA2-12D3	DLA2-06DBC	DLA2-06D3
Description		Telecom/Data SPD- 2-pair -DIN mounting - Pluggable						
Network		Telephone line, ADSL2, VDSL	Fipway, WorldFIP, FieldBus-h2	ISDN-T0, 48 V line	4-20 mA	RS232, RS485	MIC/T2, 10BaseT	RS422
SPD configuration		2-pair + shield	2-pair + shield	2-pair + shield	2-pair + shield	2-pair + shield	2-pair + shield	2-pair + shield
Nominal line voltage	Un	150 V	48 V	48 V	24 V	12 V	6 V	6 V
Max. DC operating voltage	Uc	170 V	53 V	53 V	28 V	15 V	8 V	8 V
Max. Load current	IL	300 mA	300 mA	300 mA	300 mA	300 mA	300 mA	300 mA
Max. frequency	f max	> 10 MHz	> 20 MHz	> 3 MHz	> 3 MHz	> 3 MHz	> 20 MHz	> 3 MHz
Insertion loss @ fmax		< 1 dB	< 1 dB	< 1 dB	< 1 dB	< 1 dB	< 1 dB	< 1 dB
Nominal discharge current 8/20µs Test x 10 - C2 Category	In	5 kA	5 kA	5 kA	5 kA	5 kA	5 kA	5 kA
Max. discharge current -max. withstand @ 8/20 µs by pole	Imax	20 kA	20 kA	20 kA	20 kA	20 kA	20 kA	20 kA
Impulse current 2 x 10/350µs Test - D1 Category	Iimp	5 kA	5 kA	5 kA	5 kA	5 kA	5 kA	5 kA
Protection level following C3 Category test	Up	220 V	75 V	70 V	40 V	30 V	25 V	20 V
Failsafe behavior		Short-circuit	Short-circuit	Short-circuit	Short-circuit	Short-circuit	Short-circuit	Short-circuit
Mechanical characteristics								
Dimensions		see diagram						
Format		Plug-in DIN box						
Connection to Network		screw terminal - cross section 0.4-1.5 mm ²						
Disconnection indicator		transmission interrupt - Default Mode 2						
Mounting		Symmetrical rail 35 mm (EN60715)						
Operating temperature		-40/+85°C						
Protection rating		IP20						
Housing material		Thermoplastic UL94 V-0						
Spare module		DLA2M-170	DLA2M-48DBC	DLA2M-48D3	DLA2M-24D3	DLA2M-12D3	DLA2M-06DBC	DLA2M-06D3
Standards								
Compliance		IEC 61643-21 / EN 61643-21 / UL497A						
Part number								
		640611	640314	640312	640311	640211	640131	640111

2-PAIR DIN RAIL PLUG-IN SURGE PROTECTOR FOR DATALINE/TELECOM

DLA2-**xxx** **D3**

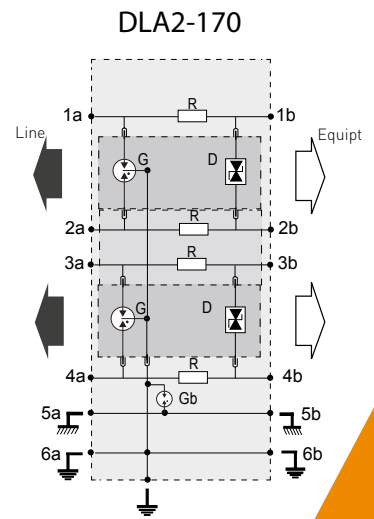
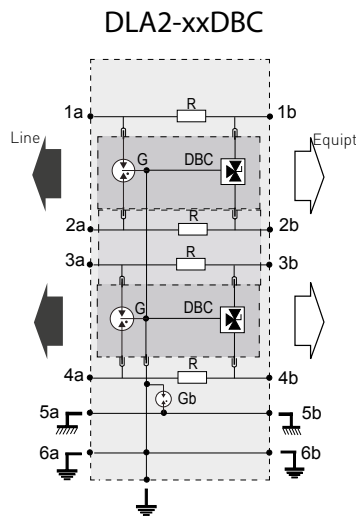
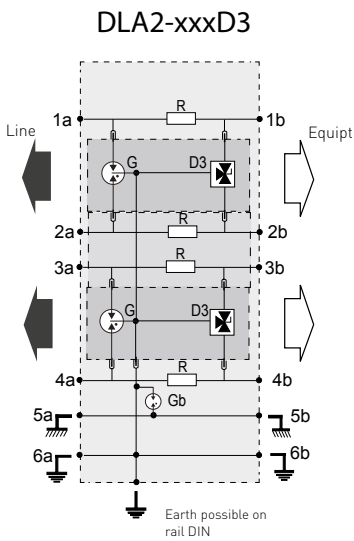
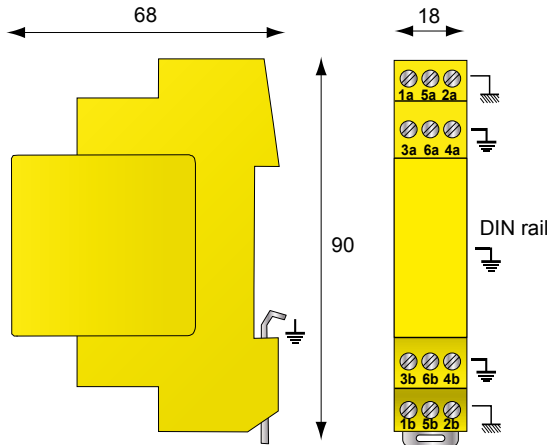
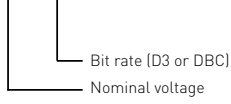

- G: 3-electrode gas tube
- Gb: 2-electrode gas tube
- R: Resistor
- D: Clamping diode

DLA-IS



DLA-06-IS

- Pluggable surge protection for «DIN» mounting
- For RS422 or RS485 Datalines
- 1-pair + Signal ground + Shield protection
- IEC 61643-21 / UL497A compliance

Characteristics

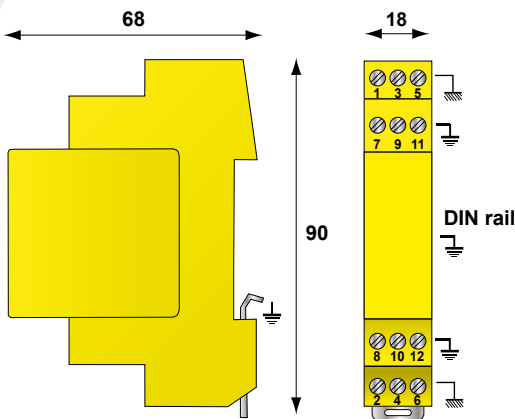

CITEL Model	DLA-06-IS	DLA-12-IS
Description	1-pair Data SPD - DIN mounting	Pluggable
Network	RS422	RS232 / RS485
SPD configuration	1-pair + Signal Ground + shield	1-pair + Signal Ground + shield
Nominal line voltage	Un 6 V	12 V
Max. DC operating voltage	Uc 8 V	15 V
Max. Load current	IL 2.4 A	2.4 A
Max. frequency	f max > 3 MHz	> 3 MHz
Insertion loss @ fmax	< 1 dB	< 1 dB
Nominal discharge current <i>8/20µs Test x 10 - C2 Category</i>	In 5 kA	5 kA
Max. discharge current <i>max. withstand @ 8/20 µs by pole</i>	Imax 20 kA	20 kA
Impulse current <i>2 x 10/350µs Test - D1 Category</i>	Iimp 5 kA	5 kA
Protection level <i>following C3 Category test</i>	Up 20 V/650 V	30 V/650 V
Failsafe behavior	Short-circuit	Short-circuit

Mechanical characteristics

Dimensions	see diagram	
Format	Plug-in DIN box	
Connection to Network	screw terminal - cross section 0.4-1.5 mm ²	
Disconnection indicator	transmission interrupt - Default Mode 2	
Mounting	Symmetrical rail 35 mm (EN60715)	
Operating temperature	-40/+85°C	
Protection rating	IP20	
Housing material	Thermoplastic UL94 V-0	
Spare module	DLAM-06-IS	DLAM-12-IS

Standards

Compliance	IEC 61643-21 / EN 61643-21 / UL497A
------------	-------------------------------------

Part number

	6406011	640152
--	---------	--------

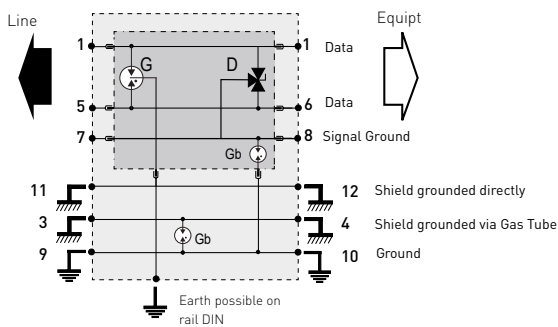

G: 3-electrode gas tube
 Gb: 2-electrode gas tube
 D: Clamping diode

DLAS1 SERIES



- 1-pair Pluggable SPD for dataline
- Visual indicator in failsafe behaviour
- Line voltage from 6 to 48 Vdc
- Without line cut-off (DLAS1) or with (DLAWS1)
- DIN rail mounting ,Screw or spring contact terminals
- IEC/EN 61643-21 and UL497A compliance

Characteristics

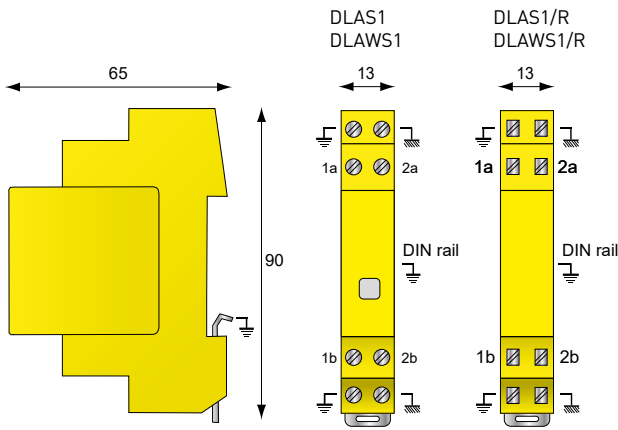

CITEL Model	DLAS1-48D3	DLAS1-24D3	DLAS1-12D3	DLAS1-06D3
Description	Telecom/Data SPD- 1-pair -DIN mounting - Pluggable			
Network	ISDN-T0, 48 V line	4-20 mA	RS232, RS485	RS422
SPD configuration	1-pair + shield	1-pair + shield	1-pair + shield	1-pair + shield
Nominal line voltage	Un 48 V	24 V	12 V	6 V
Max. DC operating voltage	Uc 53 V	28 V	15 V	8 V
Max. Load current	IL 300 mA	300 mA	300 mA	300 mA
Max. frequency	f max > 3 MHz	> 3 MHz	> 3 MHz	> 3 MHz
Insertion loss @ fmax	< 1 dB	< 1 dB	< 1 dB	< 1 dB
Nominal discharge current	In 5 kA	5 kA	5 kA	5 kA
Max. discharge current	Imax 20 kA	20 kA	20 kA	20 kA
Impulse current	Iimp 5 kA	5 kA	5 kA	5 kA
Protection level	Up 70 V	40 V	30 V	20 V
Failsafe behavior	Opening line + indication			

Mechanical characteristics				
Dimensions	see diagram			
Format	Plug-in DIN box			
Connection to Network	screw terminal - cross section 0.4-1.5 mm ²			
End of life	transmission interrupt - default mode 2			
Disconnection indicator	Red indicator			
Mounting	Symmetrical rail 35 mm (EN60715)			
Operating temperature	-40/+85°C			
Protection rating	IP20			
Housing material	Thermoplastic UL94 V-0			
Spare module	DLAS1M-48D3	DLAS1M-24D3	DLAS1M-12D3	DLAS1M-06D3
Version	DLAS1-xxx: standard version - screw terminal DLAS1-xxx/R: spring contact terminal version DLAWS1-xxx: specific version with line cut-off in case of removal plug-in module DLAWS1-XXX/R: spring contact terminal version			

Standards	
Compliance	IEC 61643-21 / EN 61643-21 / UL497A

Part number				
DLAS1-xxx version	6415041	6415031	6415021	6415011
DLAS1-xxx/R version	6415044	6415034	6415024	6415014
DLAWS1-xxx version	6419041	6419031	6419021	6419011
DLAWS1-xxx/R version	6419044	6419034	6419024	6419014

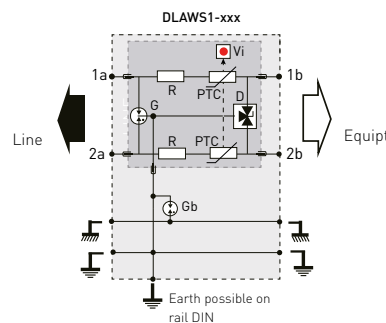
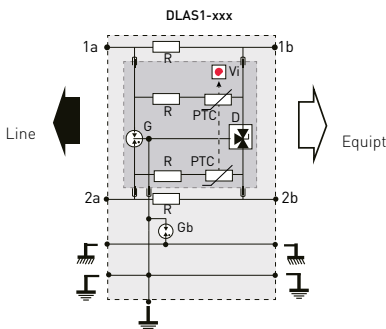

G: 3-electrode gas tube
 Gb: 2-electrode gas tube
 PTC: Thermal resistor
 T : Resistor
 D: Clamping diode
 Vi: Failure Indicator

DIN RAIL PLUG-IN SURGE PROTECTOR FOR DATALINE/TELECOM WITH REMOTE FAILURE INDICATION

DLATS1 SERIES



- 1-pair dataline/telecom surge protection
- Local and Remote signaling of SPD status
- DIN rail mounting , Screw or Spring contact terminals
- Plug-in module
- 1 monitoring module + SPD modules (up to 48) + bus
- Discharge current I_{max}/I_n : 20 kA / 5 kA
- Complies with IEC/EN 61643-21, UL497A

Characteristics

CITEL Model		DLATS1-170	DLATS1-48D3	DLATS1-24D3	DLATS1-12D3	DLATS1-06D3	DLATS1-P24DC
Description		Telecom/Data SPD- 1-pair + shield DIN mounting - Pluggable - Local & Remote signalling					Power supply/ Monitoring module
Network		Telephone line, ADSL2, VDSL	ISDN-T0, 48 V line	4-20 mA	RS232, RS485	RS422	
Configuration		1-pair + shield	1-pair + shield	1-pair + shield	1-pair + shield	1-pair + shield	24 Vdc powered
Nominal line voltage	Un	150 V	48 V	24 V	12 V	6 V	24 Vdc
Max. DC operating voltage	Uc	170 V	53 V	28 V	15 V	8 V	-
Max. Load current	IL	300 mA	300 mA	300 mA	300 mA	300 mA	-
Max. frequency	f max	10 MHz	3 MHz	3 MHz	3 MHz	3 MHz	-
Insertion loss @ fmax		< 1 dB	< 1 dB	< 1 dB	< 1 dB	< 1 dB	-
Nominal discharge current 8/20µs Test x 10 - C2 Category	In	5 kA	5 kA	5 kA	5 kA	5 kA	-
Max. discharge current max. withstand @ 8/20 µs by pole	I _{max}	20 kA	20 kA	20 kA	20 kA	20 kA	-
Impulse current 2 x 10/350µs Test - D1 Category	I _{imp}	5 kA	5 kA	5 kA	5 kA	5 kA	-
Protection level following C3 Category test	Up	220 V	70 V	40 V	30 V	20 V	-
Failsafe behavior		Short circuit/ Line disconnection	Short circuit/ Line disconnection	Short circuit/ Line disconnection	Short circuit/ Line disconnection	Short circuit/ Line disconnection	-
Mechanical characteristics							
Dimensions		see diagram					
Format		Plug-in DIN box					
Connection to Network		Screw terminal (DLATS1-xxx) or spring terminal (DLATS1-xxx/R) : : wire cross section 0.4-1.5 mm ²					
Overstressed default mode		transmission interrupt - default mode 2					
Operating/fault indicator		Green/Red					
Remote Signaling		through control module					
Mounting		Symmetrical rail 35 mm (EN60715)					
Operating temperature		-40/+85°C					
Protection rating		IP20					
Housing material		Thermoplastic UL94 V-0					
Spare module		DLATS1M-170	DLATS1M-48D3	DLATS1M-24D3	DLATS1M-12D3	DLATS1M-06D3	DLATS1M-P24DC
Version		DLATS1-xxx: standard version - screw terminal DLATS1-xxx/R: spring contact terminal version DLAWTS1-xxx: specific version with line cut-off in case of removal plug-in module DLAWTS1-XXX/R: spring contact terminal version					
Connection bus		SPD/control module connection by bus: bus 1+4 (1 control module+4 SPD), bus 1+9, bus 1+24, bus 1+48					
Standards							
Compliance		IEC 61643-21 / EN 61643-21 / UL497A					
Part number							
DLATS1-xxx version		6417051	6417041	6417031	6417021	6417011	6417231
DLATS1-xxx/R version		6417054	6417044	6417034	6417024	6417014	
DLAWTS1-xxx version		6421051	6421041	6421031	6421021	6421011	
DLAWTS1-xxx/R version		6421054	6421044	6421034	6421024	6421014	



DIN RAIL PLUG-IN SURGE PROTECTOR FOR DATALINE/TELECOM WITH REMOTE FAILURE INDICATION

DLAWTS1-xxxD3/R

- Wiring: « » = Screw connection
- «R» = Spring connection
- Nominal voltage
- Remote Failure indication
- « » = Line continuity if plugout
- «W» = Line cut-off if plugout

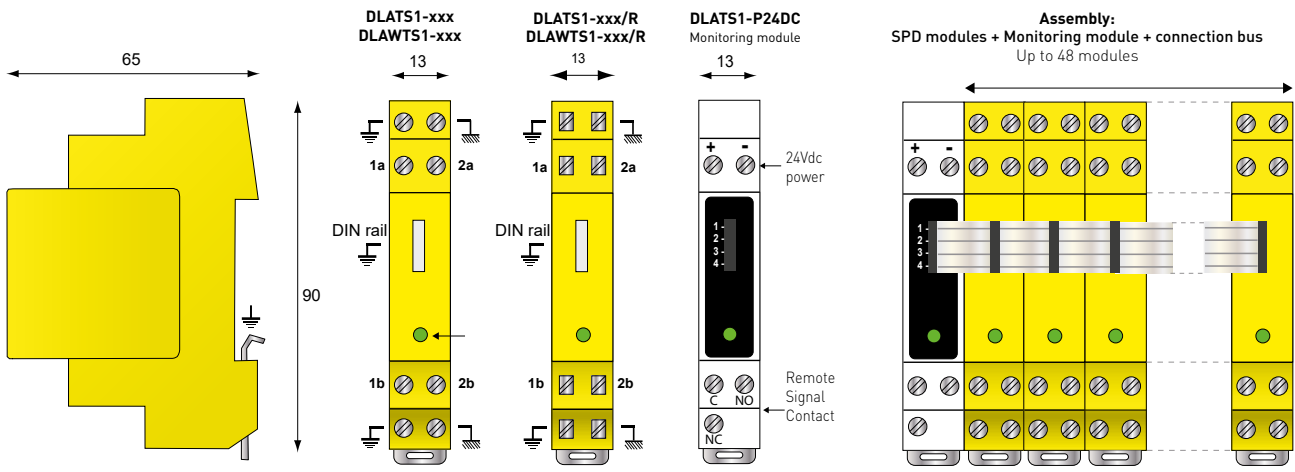

**DLATS1-xxx
DLATS1-xxx/R**
Line continuity if plugout

**DLAWTS1-xxx
DLAWTS1-xxx/R**
Line cut-off if plugout

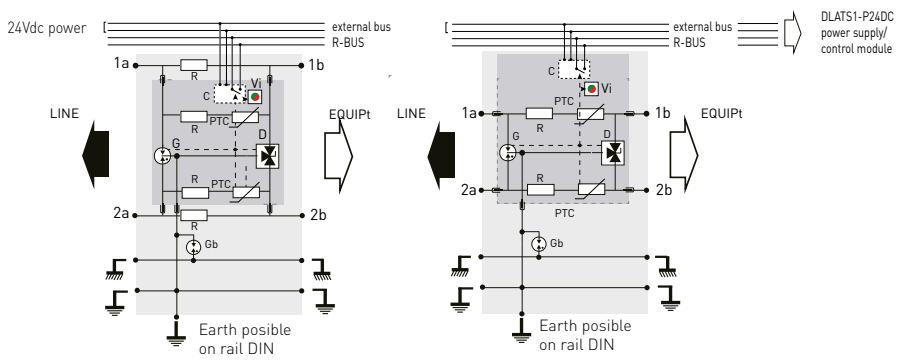

- G: 3-electrode gas tube
- Gb: 2-electrode gas tube
- R: Resistor
- PTC: Thermal Resistor
- D: Clamping diode
- Vi: Operating/Failure indicator
- C: Remote signaling contact

DLU, DLU2 SERIES



- For «DIN» rail mounting, Monobloc housing
- All types of Telephone and Data lines
- 1-pair (DLU) or 2-pair version (DLU2)
- Transmission and protection of shield wire (DLU)
- IEC 61643-21 compliance
- UL497 A approved

Characteristics

CITEL Model	DLU-170	DLU-48DBC	DLU-48D3	DLU-24D3	DLU-12D3	DLU-06DBC	DLU-06D3	
	DLU2-170	DLU2-48DBC	DLU2-48D3	DLU2-24D3	DLU2-12D3	DLU2-06DBC	DLU2-06D3	
Description	Telecom/Data SPD - 1 or 2-pair -DIN mounting - Monobloc							
Network	Telephone line, ADSL2, VDSL	Fipway, World-FIP, FieldBus-H2,	48V line, ISDN-T0, Profibus-PA	4-20mA, 24V line	Profibus-FMS, Interbus, Fiel-dBus-H1, RS232, RS485	6V line, High bitrate, MIC/T2, 10BaseT	RS422	
SPD configuration	DLU 1-pair + shield DLU2 2 pairs	1-pair + shield 2 pairs	1-pair + shielded 2 pairs	1-pair + shield 2 pairs	1-pair + shield 2 pairs	1-pair + shield 2 pairs	1-pair + shield 2 pairs	
Nominal line voltage	Un 150 V	48 V	48 V	24 V	12 V	6 V	6 V	
Max. DC operating voltage	Uc 170 V	53 V	53 V	28 V	15 V	10 V	10 V	
Max. Load current	IL 300 mA	300 mA	300 mA	300 mA	300 mA	300 mA	300 mA	
Max. frequency	f max > 10 MHz	> 20 MHz	> 3 MHz	> 3 MHz	> 3 MHz	> 20 MHz	> 3 MHz	
Insertion loss @ fmax	< 1 dB	< 1 dB	< 1 dB	< 1 dB	< 1 dB	< 1 dB	< 1 dB	
Nominal discharge current 8/20µs Test x 10 - C2 Category	In 5 kA	5 kA	5 kA	5 kA	5 kA	5 kA	5 kA	
Max. discharge current -max. withstand @ 8/20 µs by pole	Imax 20 kA	20 kA	20 kA	20 kA	20 kA	20 kA	20 kA	
Impulse current 2 x 10/350µs Test - D1 Category	Iimp 5 kA	5 kA	5 kA	5 kA	5 kA	5 kA	5 kA	
Protection level following C3 Category test	Up 220 V	75 V	70 V	40 V	30 V	25 V	20 V	
Failsafe behavior	Short-circuit	Short-circuit	Short-circuit	Short-circuit	Short-circuit	Short-circuit	Short-circuit	
Mechanical characteristics								
Dimensions	see diagram							
Format	DIN box							
Connection to Network	screw terminal - cross section 0.4-1.5 mm ²							
Disconnection indicator	transmission interrupt - default mode 2							
Mounting	Symmetrical rail 35 mm [EN60715]							
Operating temperature	-40/+85°C							
Protection rating	IP20							
Housing material	Thermoplastic UL94 V-0							
Versions	DLU-xxx: version 1 pair DLU2-xxx: version 2 pairs DLUH-xxx: «remote supply» version 1-pair (max. line current IL = 2,4 A) DLUH2-xxx: «remote supply» version 2 pairs (max. line current IL = 2,4 A)							
Standards								
Compliance	IEC 61643-21 / EN 61643-21 / UL497A							
Part number								
DLU range	640505	640514	640504	640503	640502	640511	640501	
DLUH range	640705	640714	640704	640703	640702	640711	640701	
DLU2 range	640405	640434	640404	640401	640403	640431	640402	
DLUH2 range	-	640744	640734	640733	640732	640741	640731	

DIN RAIL SURGE PROTECTOR FOR DATALINE/TELECOM

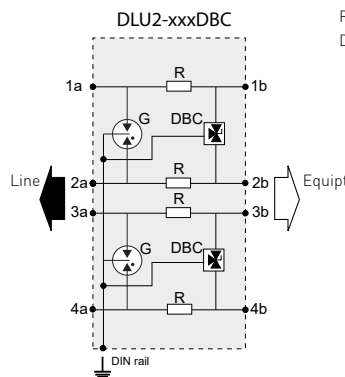
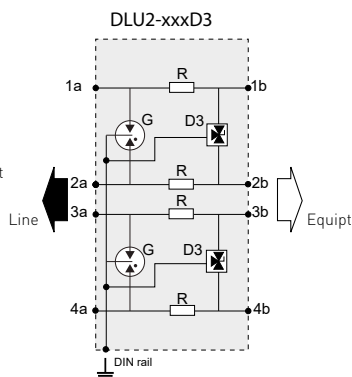
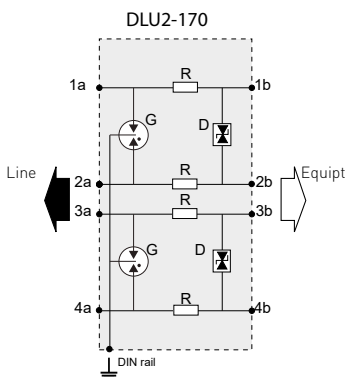
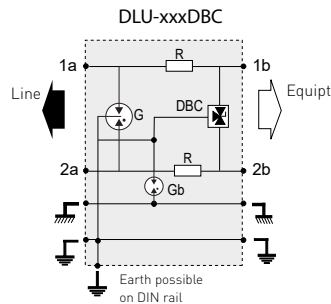
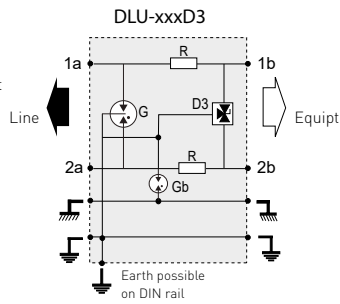
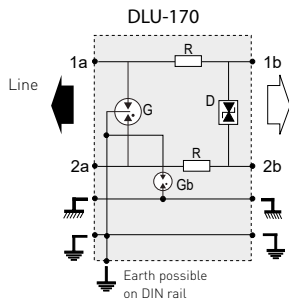
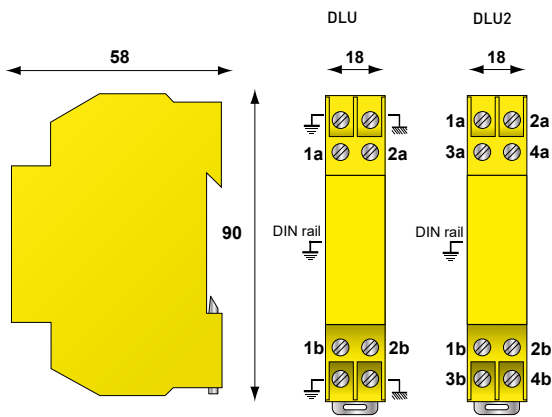
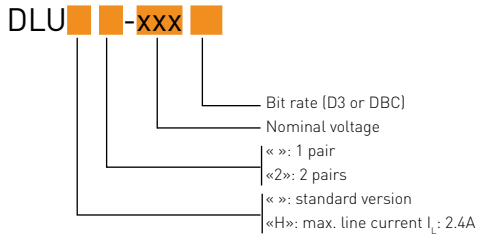

- G: 3-electrode gas tube
- Gb: 2-electrode gas tube
- R: Resistor (or L: inductor for DLUH version)
- D: Clamping diode

DLC SERIES

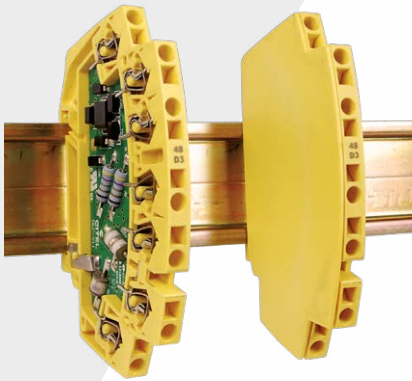

- Compact SPD for Datalines
- For «DIN» rail mounting
- All types of Telephone and Data lines
- Spring contact terminal
- Protection of shield wire
- IEC 61643-21 compliance

Characteristics

CITEL Model	DLC-170	DLC-48DBC	DLC-48D3	DLC-24D3	DLC-12D3	DLC-06DBC	DLC-06D3	
Description	1-pair monobloc Telecom surge protector							
Network	Telephone line, ADSL2, VDSL	Fipway, World-FIP, FieldBus-H2	ISDN-T0, Line 48V	LS, 4-20mA	RS232, RS485	MIC/T2, 10BaseT	RS422	
SPD configuration	1-pair + shielded	1-pair + shielded	1-pair + shielded	1-pair + shielded	1-pair + shielded	1-pair + shielded	1-pair + shielded	
Nominal line voltage	Un 150 V	48 V	48 V	24 V	12 V	6 V	6 V	
Max. DC operating voltage	Uc 170 V	53 V	53 V	28 V	15 V	8 V	8 V	
Max. Load current	IL 300 mA	300 mA	300 mA	300 mA	300 mA	300 mA	300 mA	
Max. frequency	f max > 10 MHz	> 20 MHz	> 3 MHz	> 3 MHz	> 3 MHz	> 20 MHz	> 3 MHz	
Insertion loss @ fmax	< 1 dB	< 1 dB	< 1 dB	< 1 dB	< 1 dB	< 1 dB	< 1 dB	
Nominal discharge current <i>8/20µs Test x 10 - C2 Category</i>	In 5 kA	5 kA	5 kA	5 kA	5 kA	5 kA	5 kA	
Max. discharge current -max. <i>withstand @ 8/20 µs by pole</i>	Imax 10 kA	10 kA	10 kA	10 kA	10 kA	10 kA	10 kA	
Impulse current <i>2 x 10/350µs Test - D1 Category</i>	Iimp 2.5 kA	2.5 kA	2.5 kA	2.5 kA	2.5 kA	2.5 kA	2.5 kA	
Protection level <i>following C3 Category test</i>	Up 220 V	70 V	70 V	40 V	30 V	25 V	25 V	
Failsafe behavior	Short-circuit	Short-circuit	Short-circuit	Short-circuit	Short-circuit	Short-circuit	Short-circuit	
Mechanical characteristics								
Dimensions	see diagram							
Format	DIN box							
Connection to Network	by spring - max. cross section 1.5 mm ²							
Disconnection indicator	transmission interrupt -default mode 2							
Mounting	Symmetrical rail DIN 35 mm (EN60715)							
Operating temperature	-40/+85°C							
Protection rating	IP20							
Housing material	Thermoplastic UL94 V-0							
Standards								
Compliance	IEC 61643-21 / EN 61643-21 / UL497A							
Part number								
	641105	641114	641104	641103	641102	641111	641101	

1-PAIR DIN RAIL SURGE PROTECTOR FOR DATALINE/TELECOM

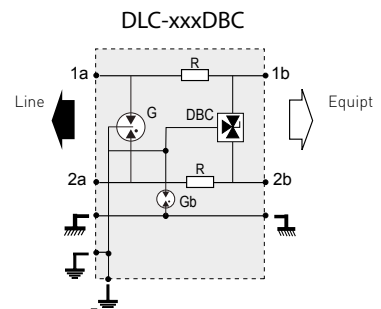
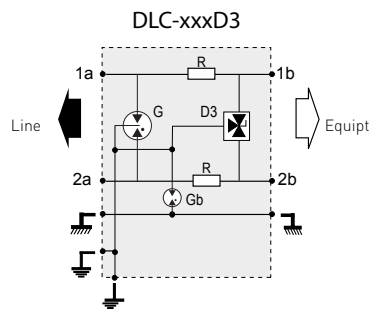
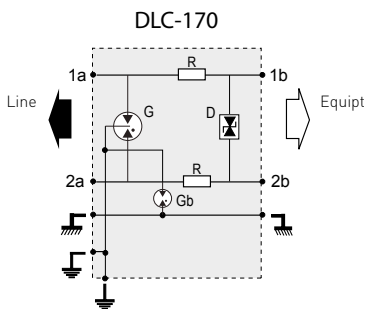
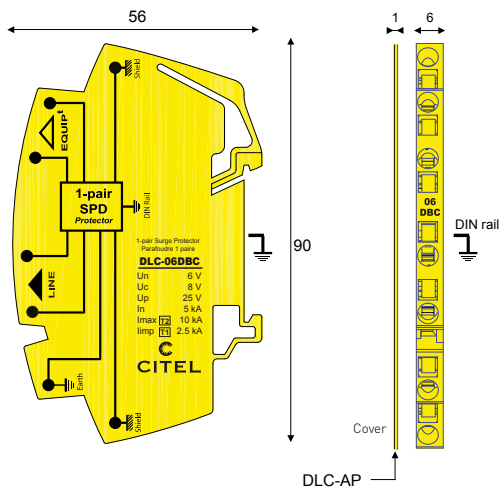
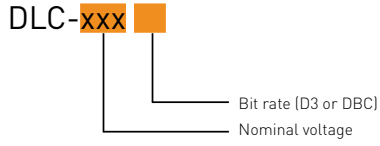

- G: 3-electrode gas tube
- Gb: 2-electrode gas tube
- PB: 2-electrode gas tube
- R: Resistor
- D: Clamping diode

B180, B280, B480 SERIES

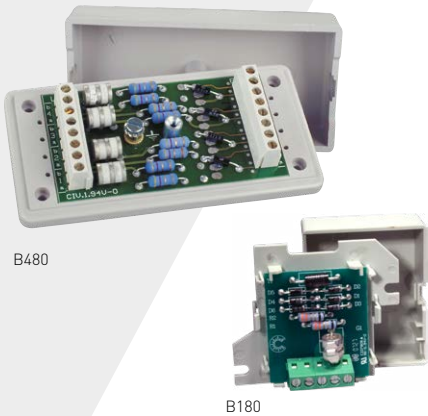

- 1 to 4-pair surge protection units
- All types of telephone and data lines
- Removable protection circuit
- Wall mounting and screw connection
- IEC 61643-21 compliance
- UL497A approved

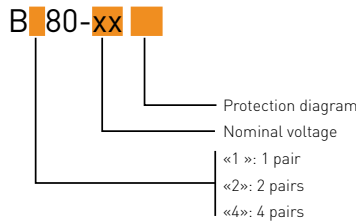

Characteristics

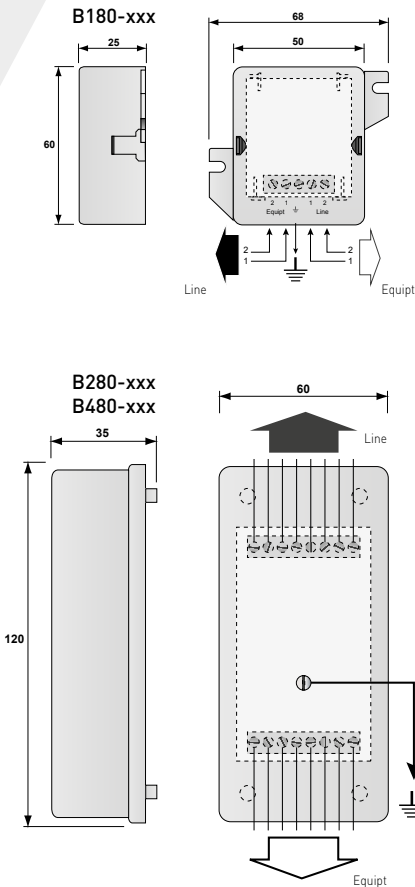

CITEL Model	B180-T	B180-48D3	B180-24D3	B180-12D3	B180-06D3
	B280-T	B280-48D3	B280-24D3	B280-12D3	B280-06D3
	B480-T	B480-48D3	B480-24D3	B280-12D3	B480-06D3
Description	Surge protector box - 1, 2 or 4 pairs				
Network	Tephone line, ADSL2, VDSL	ISDN-T0, 48 V line	4-20 mA	RS232, RS485	RS422 10 Base T
SPD configuration	B180: 1 pair B280: 2 pairs B480: 4 pairs	1 pair 2 pairs 4 pairs	1 pair 2 pairs 4 pairs	1 pair 2 pairs 2 pairs	1 pair 2 pairs 4 pairs
Nominal line voltage	Un	150 V	48 V	24 V	12 V
Max. DC operating voltage	Uc	170 V	53 V	28 V	15 V
Max. Load current	IL	300 mA	300 mA	300 mA	300 mA
Max. frequency	f max	10 MHz	20 MHz	20 MHz	20 MHz
Insertion loss @ fmax		< 1 dB	< 1 dB	< 1 dB	< 1 dB
Nominal discharge current 8/20µs Test x 10 - C2 Category	In	5 kA	5 kA	5 kA	5 kA
Max. discharge current max. withstand @ 8/20 µs by pole	Imax	20 kA	20 kA	20 kA	20 kA
Impulse current 2 x 10/350µs Test - D1 Category	Iimp	2.5 kA	2.5 kA	2.5 kA	2.5 kA
Protection level following C3 Category test	Up	220 V	70 V	40 V	30 V
Failsafe behavior	Short-circuit	Short-circuit	Short-circuit	Short-circuit	Short-circuit
Mechanical characteristics					
Dimensions	see diagram				
Format	wall mounting box				
Disconnection indicator	transmission interrupt - default mode 2				
Mounting	wall (screws non included)				
Operating temperature	-40/+85°C				
Protection rating	IP20				
Housing material	Thermoplastic UL94 V-0				
Spare unit	S180-T	S180-48D3	S180-24D3	S180-12D3	S180-06D3
Spare unit	S280-T	S280-48D3	S280-24D3	S280-12D3	S280-06D3
Spare unit	S480-T	S480-48D3	S480-24D3	S280-12D3	S480-06D3
Standards					
	IEC 61643-21 / EN 61643-21 / UL497A				
Part number					
B180 range	510602	510402	510302	510202	510102
B280 range	72726	72774	72773	72772	72771
B480 range	72746	72794	72793	72772	72791

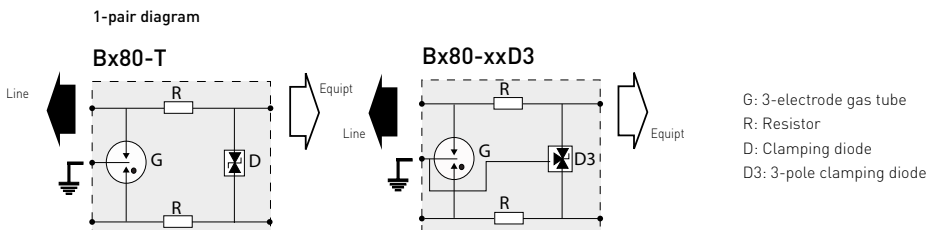

CL-DSL



- Surge protection for telecommunication lines
- Protection for VDSL2, ADSL2, ISDN and analog lines
- Extended bandwidth up to 400 MHz
- Wall mounting and screwless terminals
- EN 61643-21 / IEC 61643-21 compliance

Characteristics

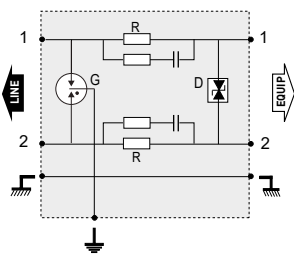
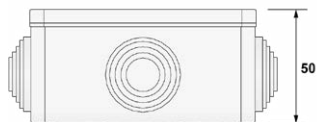
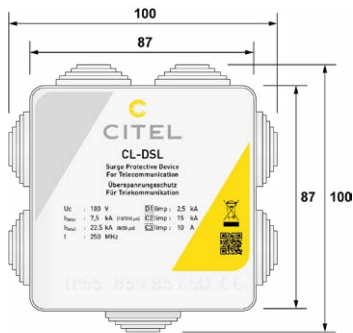

G: 3-electrode gas tube
 R: Resistor
 D: Clamping diode

CITEL Model		B180-T
Description		Surge protector box - 1-pair
Network		VDSL2, ADSL2, ISDN, PSTN
Nominal line voltage	Un	150 V
Max. DC operating voltage	Uc	180 V
Max. Load current	IL	750 mA
Max. frequency	f max	400 MHz
Insertion loss @ fmax		< 3 dB
Nominal discharge current 8/20µs Test x 10 - C2 Category	In	15 kA
Impulse current 2 x 10/350µs Test - D1 Category	Iimp	2.5 kA
Protection level following C3 Category test	Up	350 V
Failsafe behavior		Short-circuit
Mechanical characteristics		
Dimensions		see diagram
Format		wall mounting box
Connection to network		screwless terminal - cross section 0.4-1.5 mm ²
Disconnection indicator		transmission interrupt - default mode 2
Mounting		wall (screws non included)
Operating temperature		-40/+85°C
Protection rating		IP55
Housing material		Thermoplastic UL94 V-0
Standards		
		IEC 61643-21 / EN 61643-21 / UL497A
Part number		
		6400066

MJ8, MJ6-1T/D



MJ6-1T/D



MJ8-170V

- Protection for one telephone line
- For PSTN, ISDN, ADSL lines
- Quick installation
- RJ11 or RJ45 connectors
- IEC 61643-21 compliance
- UL497A approved

Characteristics

CITEL Model		MJ6-1T/D	MJ8-ISDN	MJ8-170V
Description		RJ11 surge protector for 1 telephone line	RJ45 surge protector for 1 ISDN line	Surge protector for telephone line 1 to 4-pairs
Network		PSTN, ADSL2, VDSL	ISDN, 48 V line	PSTN, ADSL2, VDSL-4 pairs
Max. data rate		30 Mbps	30 Mbps	30 Mbps
SPD configuration		1-pair + shielded	2 pairs + shielded	4 pairs + shielded
Pin outs		1-pair (3-4)	2-pairs (3-6)(4-5)	4-pairs (1-2)(3-6)(4-5)(7-8)
Nominal line voltage	Un	150 V	48 Vdc	150 Vdc
Max. DC operating voltage	Uc	170 Vdc	60 Vdc	170 Vdc
Max. Load current	IL	300 mA	1000 mA	1000 mA
Max. frequency	f max	10 MHz	10 MHz	10 MHz
Insertion loss @ fmax		< 1 dB	< 1 dB	< 1 dB
Nominal discharge current Line/Ground	In	2500 A	2000 A	2000 A
8/20µs Test x 10 - C2 category				
Nominal discharge current Line/Line	In	2500 A	500 A	500 A
8/20µs Test x 10 - C2 category				
Impulse current	Iimp	500 A	500 A	500 A
2 x 10/350µs Test - D1 Category				
Protection level	Up	220 V	70 V	220 V
following C3 Category test				
Failsafe behavior		Short-circuit	Short-circuit	Short-circuit
Mechanical characteristics				
Dimensions		see diagram		
Format		RJ11 Connector	RJ45 connector	
Connection to Network		RJ11 connector female input/output	RJ45 connector female input/output	
Disconnection indicator		transmission interrupt - default mode 2		
Mounting		Mounting flange or Screw lug or DIN Rail		
Operating temperature		-40/+85°C		
Protection rating		IP20		
Housing material		Aluminium		
Standards				
Compliance		IEC 61643-21 / EN 61643-21 / UL497A		
Part number				
		560412	560209	560203

MJ6-1T/D

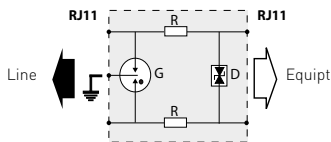
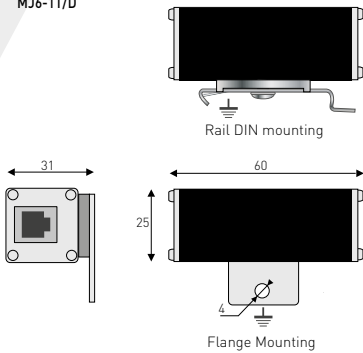

MJ8

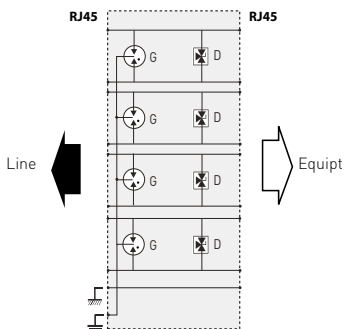
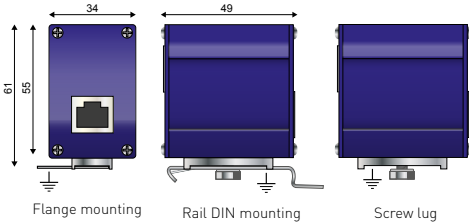

G: 3-pole gas tube
R: Resistor
D: Clamping Diode



CITEL



COMPUTER NETWORK SURGE PROTECTORS

COMPUTER NETWORK SURGE PROTECTORS



PROTECTING DATA-PROCESSING NETWORKS

For industrial sites or business buildings integrating Local Area Networks (LAN), any single issue at one of these systems will create consequences, more or less, to the safety and productivity of the entire system.

It is now more and more crucial to reinforce the level of reliability for these systems: this can be achieved by using a proper surge protection strategy for these sensitive networks.

As is the case in telecom or industrial networks, the installation of surge protectors on data-processing networks is necessary, especially in the following cases:

- » Inter-building networks
- » Wide networks
- » High Electromagnetic disturbance density
- » Heavy Lightning exposure

As for the other types of transmission lines, CITEL surge protectors for LANs are based on an association of 3-pole gas tubes and fast clamping diodes to ensure efficiency on lightning surges. In addition, two additional parameters need to be taken into account: the voltage level of the application and the very high data transmission speed. CITEL surge protectors for data-processing networks are designed for both of these requirements.

Performances

Ethernet network surge protectors are designed for computer networks with very fast data transfer speed up to 10 Gbit/s for the Ethernet Category 6A networks. In order to cover the many various types of networking applications, CITEL offers a complete range of surge protectors adapted to these Ethernet and PoE networks.

Standard

Surge protectors for LAN are in compliance with IEC 61643-21.

CITEL RANGE FOR ETHERNET & POE

CITEL Surge protector for LAN can be adapted to the different configurations. They are equipped with the network connection (RJ45) and available either in an individual box for the protection of an isolated terminal, or in a 19" Rack version for multi-line protection at hub or server level.

Surge Protectors for terminal equipment

CITEL offers several configurations depending on the types of network and the performance protection required:



The MJ8-C6A are dedicated all STP (shielded cable) Ethernet networks up to the Category 6A. Their GDT/Diodes circuit gives them the discharge capacity necessary for the protection of inter-building connections.



The MJ8-POE-C6A are designed to protect indoor equipment connected to PoE++ networks, up to Category 6 A.



The CxMJ8-POE-C6A are designed to protect outdoor equipment connected to PoE++ networks, up to Category 6 A.

TRANSMISSION CURVES (MJ8-C6A)

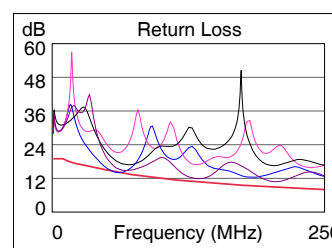
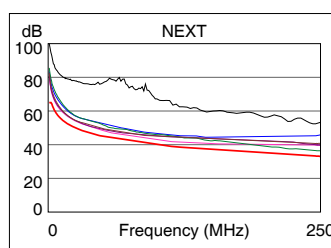
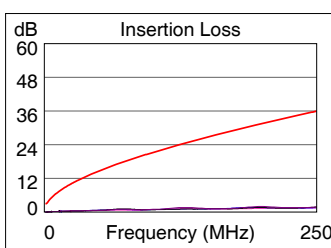

Multi-port surge protectors 19" Rack format

CITEL offers several configurations depending on the types of network and the protection performance required:

PL range

Available in 24 and 12 ports. Category 6 compatible. Shielded RJ45 input/output. STP cabling. GDT/diodes diagram.



RAK range

Available in 32 and 16 ports. Category 6, PoE and coaxial BNC connection versions. Input/output by connectors on front. UTP cabling.

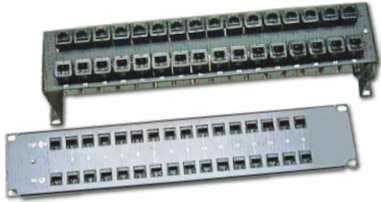

PCH range

Available in 48, 24 and 12 ports. Category 6, PoE and Telecom versions. Connection by self-stripping connectors/terminal. UTP cabling.



INSTALLATION

The surge protector for IT networks must be installed while respecting the following principles:

- SPDs must be installed on the both sides of the transmission line (e.g. server side and terminal equipment side)
- The surge protector and the protected equipment must be interconnected with the bonding network of the installation.
- The earthing conductor (between the earth output of the SPD and the bonding circuit of the installation) must be as short as possible (less than 0.50 m).
- The AC power supply of the equipment must also be surge protected.

PROTECTING VIDEO DATA TRANSMISSION

Video transmission lines (survey cameras) are regularly subjected to transient surges due to the nature of their distributed application. In order to insure the integrity of these installations, the application of dedicated SPDs at the equipment level (cameras) as well as at the server is absolutely necessary.

CITEL RANGE

The CITEL surge protectors for video-transmission are adapted to different configurations:

Video via coaxial cable: a surge protector is installed on the coaxial connection (CXP and CNP ranges).

The power supply as well as the control links must also be protected : The MSP-VM-2P surge protectors bring together all the protection devices in one single unit.



MSP-VM-2P



CNP

Video over IP: a MJ8-C6A surge protector must be installed on the IP connection.

The AC power supply of the terminal equipment must also be protected :The MSP-VM/R surge protector brings together all the protection devices in one single unit.



MSP-VM/R

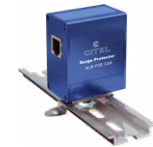

MJ8-POE-C6A

Video over PoE: a PoE compatible surge protector (MJ8-POE-C6A) must be installed on the terminal equipment. In the case of outdoor installation, the CRMJ8-POE-C6A or CWMJ8-POE-CA6 is necessary.



MJ8-POE-C6A



CRMJ8-POE-C6A

CITEL MJ8 SERIES

Installation



The protection of your Ethernet equipment.

Mounting
On Rail
or by flange

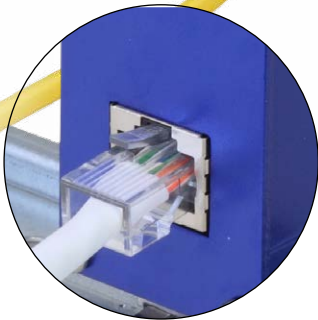
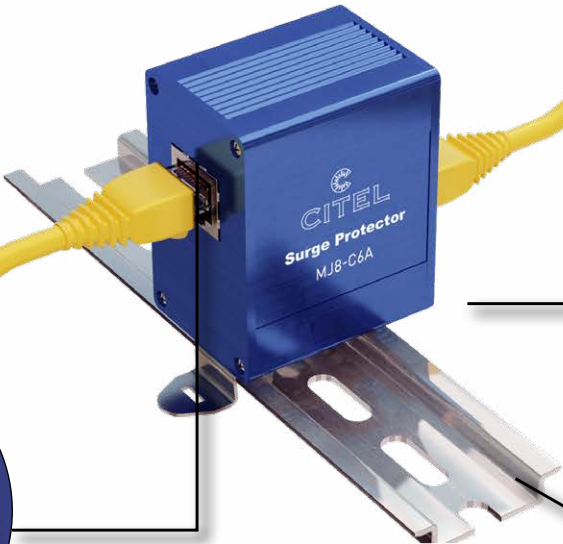
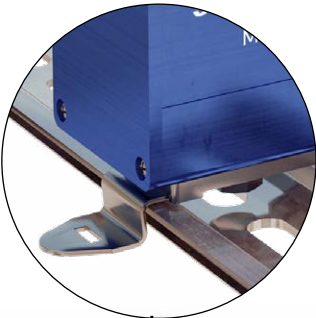

RJ45 connection
Immediate implementation by
connection of the RJ45 cables

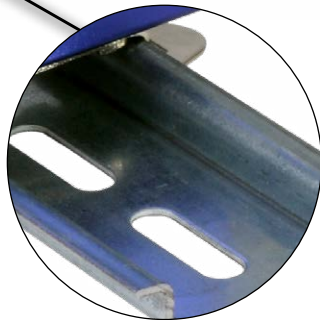

Ground connection
via DIN Rail

MJ8-C6A



- up to 10Gigabit Ethernet compatible
- Category 6A compatible
- RJ45 connectors
- Bi-directional
- Mounted on frame or DIN rail
- IEC 61643-21, EN 61643-21 and UL497B compliance

Characteristics

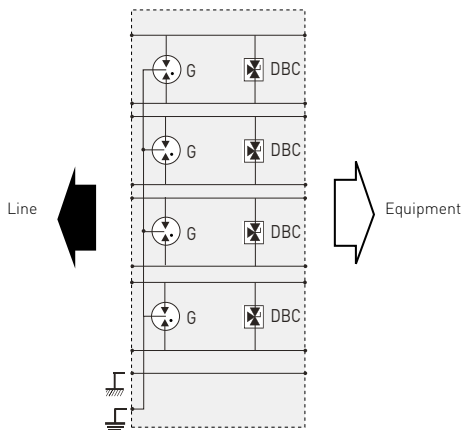
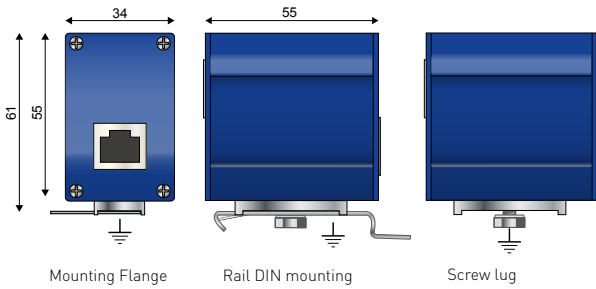

G : 3-electrode gas tube
 DBC : Low capacitance diode

CITEL Model	MJ8-C6A
Description	RJ45 surge protector for Category 6A network
Network	10Gigabit Ethernet Category 6A
Max. data rate	10 Gbps
SPD configuration	4 pairs + shield
Pin outs	(1-2)(3-6)(4-5)(7-8)
Nominal line voltage	Un 5 Vdc
Max. DC operating voltage	Uc 8 Vdc
Max. Load current	IL 1000 mA
Max. frequency	f max > 500 MHz
Insertion loss	< 1 dB
Line/Ground Nominal discharge current <i>8/20µs Test x 10 - category C2</i>	In 2000 A
Nominal discharge current Line/Line <i>8/20µs Test x 10 - category C2</i>	In 500 A
Impulse current - <i>2 x 10/350µs Test - D1 Category</i>	Iimp 500 A
Protection level <i>following C3 Category test - Line/Line</i>	Up 20 V
Failsafe behavior	Short-circuit
Mechanical characteristics	
Dimensions	see diagram
Format	RJ45 connector
Connection to Network	RJ45 shielded connector female input/output
Disconnection indicator	transmission interrupt - default mode 2
Mounting	Mounting flange, Screw lug, DIN Rail
Operating temperature	-40/+85°C
Protection rating	IP20
Housing material	Aluminium
Standards	
Compliance	IEC 61643-21 / EN 61643-21 / UL497B IEEE 802-3af/3at/3bt/ ANSI/TIA-568-C.1
Part number	
	581540

MJ8-POE SERIES



- PoE++ compatible
- up to 10Gigabit Ethernet compatible
- Category 6A or 5E compatible
- RJ45 connectors
- Bi-directional
- Mounted on frame or DIN rail
- IEC 61643-21, EN 61643-21 and UL497B compliance

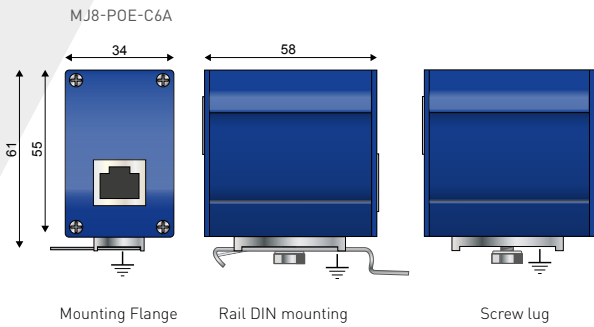

Characteristics

CITEL Model	MJ8-POE-C6A	MJ8-POE-A
Description	RJ45 surge protector for POE++	
Network	10Gigabit Ethernet, Category 6A	Gigabit Ethernet, Category 5E
Max. data rate	10 Gbps	1 Gbps
SPD configuration	4 pairs + shielded	4 pairs + shielded
Pin outs	[1-2][3-6][4-5][7-8]	[1-2][3-6][4-5][7-8]
Nominal line voltage	Un 48 Vdc	48 Vdc
Max. DC operating voltage	Uc 60 Vdc	60 Vdc
Max. Load current	IL 2000 mA	2000 mA
Max. frequency	f max > 500 MHz	> 100 MHz
Insertion loss	< 1 dB	< 1 dB
Line/Ground Nominal discharge current <i>8/20µs Test x 10 - category C2</i>	In 2000 A	2000 A
Nominal discharge current Line/Line <i>8/20µs Test x 10 - category C2</i>	In 500 A	500 A
Impulse current - <i>2 x 10/350µs Test - D1 cat.</i>	Iimp 500 A	500 A
Protection level <i>following C3 Category test - Line/Line</i>	Up 70 V	70 V
Failsafe behavior	Short-circuit	Short-circuit
Mechanical characteristics		
Dimensions	see diagram	
Format	Metallic box with connectors input/output	
Connection to Network	RJ45 shielded connector female input/output	
End of life	transmission interrupt - default mode 2	
Mounting	Mounting flange, Screw lug, DIN Rail	
Operating temperature	-40/+85°C	
Protection rating	IP20	
Housing material	Aluminium	
Standards		
Compliance	IEC 61643-21 / EN61643-21 / UL497B IEEE 802-3af/3at/3bt	IEC 61643-21 / EN 61643-21 / UL497B IEEE 802-3af/3at/3bt
Part number		
	581541	581519

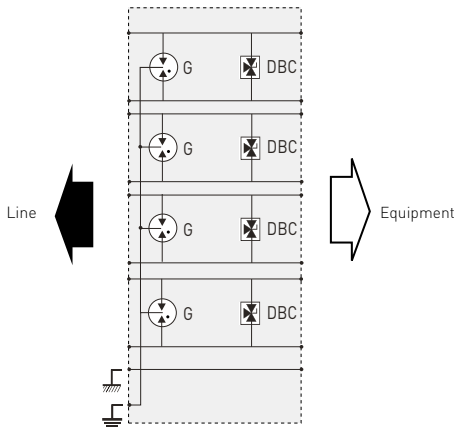

G : 3-electrode gas tube
DBC : 3-pole Low capacitance diode

SURGE PROTECTOR FOR RJ45 AND COAXIAL LINES

DIN SERIES



- BNC or RJ45 Surge protector
- Various types: Ethernet, Dataline, Telecom, Video
- Mounting on DIN rail
- Secondary protection only
- UTP (US)
- Adaptable on specific rack 19" (SPDINRAK)
- IEC 61643-21, EN 61643-21 and UL497B compliance

Characteristics

CITEL Model	DIN-E-C6	DIN-G	DIN-BNC-HD
Description	RJ45 surge protector for cat.6 network- UTP	Surge protector for telephone line	Surge protector for coaxial line
Network	Gigabit Ethernet Cat.6	RTC, ADSL2+, 4 pairs	Video line
Max. data rate	1 Gbps	40 Mbps	1000 Mbps
SPD configuration	8 wires	8 wires	1 coaxial line
Pin outs	(1-2) (3-6) (4-5) (7-8)	(1-2) (3-6) (4-5) (7-8)	-
Max. DC operating voltage	Uc 7.5 Vdc	240 Vdc	7.5 Vdc
Max. Load current	IL 750 mA	750 mA	750 mA
Max. frequency	f max > 250 MHz	> 100 MHz	> 100 MHz
Insertion loss	< 1 dB	< 1 dB	< 1 dB
Line/Ground Nominal discharge current <i>8/20µs Test x 10 - C2 category</i>	In 500 A	400 A	5000 A
Nominal discharge current Line/Line <i>8/20µs Test x 10 - C2 category</i>	In 500 A	400 A	5000 A
Impulse current <i>2 x 10/350µs Test - D1 Category</i>	Iimp -	-	500 A
Protection level <i>following C3 Category test - Line/Line</i>	Up 20 V	300 V	20 V
Failsafe behavior	Short-circuit	Short-circuit	Short-circuit
Mechanical characteristics			
Dimensions	see diagram		
Format	RJ45 Connector - UTP		connector BNC connector BNC female/female
Connection to Network	female/female RJ45 connector - UTP		
End of life	transmission interrupt - default mode 2		
Mounting	DIN rail or specific 19" rack model SPDINRAK (P/N 899001)*		
Operating temperature	-40/+85°C		
Protection rating	IP20		
Housing material	Thermoplastic UL94 V-0		
Standards			
Compliance	IEC 61643-21 / EN 61643-21 / UL497B IEEE 802-3ab	IEC 61643-21 / NF EN 61643-21 / UL497B	
Part number			
	6236	6374	6286

*] Possibility to mount 16 x DINxxx or 12 x MJ8xxx on SPDINRAK

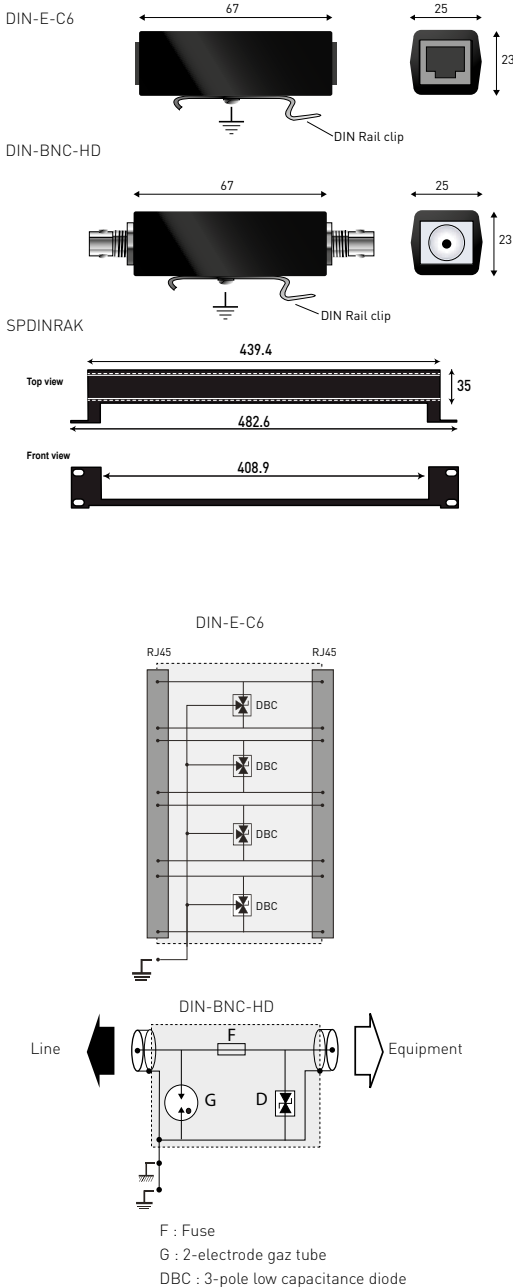

OUTDOOR POE SURGE PROTECTOR



CxMJ8-POE SERIES



- POE++ and Category 6A compatible
- up to 10Gigabit Ethernet compatible
- Outdoor application
- IP66
- Plastic (CWMJ8) or metallic (CRMJ8) enclosure
- Shielded RJ45 connectors
- IEC 61643-21, EN 61643-21 and UL497B compliance

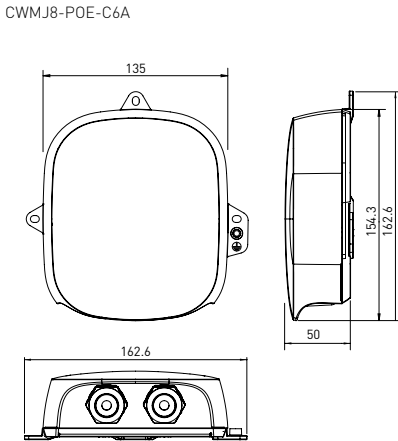
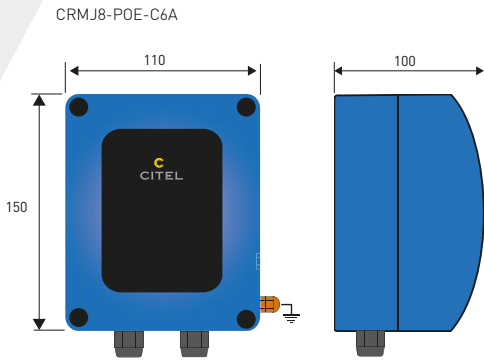

Characteristics

CITEL Model	CWMJ8-POE-C6A	CRMJ8-POE-C6A
Description	Outdoor RJ45 surge protector for POE++	Outdoor 10Gigabit POE surge protector
Network	POE++ and 10Gigabit Ethernet - Category 6A	POE++ and 10Gigabit Ethernet - Category 6A
Max. data rate	10 Gbps	10 Gbps
SPD configuration	8 wires + shielded	8 wires + shielded
Pin outs	(1-2)(3-6)(4-5)(7-8)	(1-2)(3-6)(4-5)(7-8)
Nominal line voltage	Un 48 Vdc	48 Vdc
Max. DC operating voltage	Uc 60 Vdc	60 Vdc
Max. Load current	IL 2000 mA	2000 mA
Max. frequency	f max > 500 MHz	> 500 MHz
Insertion loss	< 1 dB	< 1 dB
Line/Ground Nominal discharge current - 8/20µs Test x 10 - category C2	In 2000 A	2000 A
Nominal discharge current Line/Line - 8/20µs Test x 10 - category C2	In 500 A	500 A
Impulse current- 2 x 10/350µs Test - D1 cat	limp 500 A	500 A
Protection level following C3 Category test - Line/Line	Up 70 V	70 V
Failsafe behavior	Short-circuit	Short-circuit
Mechanical characteristics		
Spare unit	-	CRMJ8-POE-C6A/PCB
Dimensions	see diagram	
Format	Plastic Box with connectors input/output Reinforced seal	Metal Box with connectors input/output Reinforced seal
Connection to Network	RJ45 shielded connectors female input/output	
End of life	transmission interrupt - default mode 2	
Mounting	on plate or pole	
Operating temperature	-40/+85°C	
Outdoor application	yes	
Protection rating	IP66	
Housing material	Thermoplastic UL94 V-0	Aluminum cast
Standards		
Compliance	IEC 61643-21 / EN 61643-21 / UL497B IEEE 802-3af/3at/3bt/ ANSI/TIA-568-C.1	
Part number		
	581544	581542

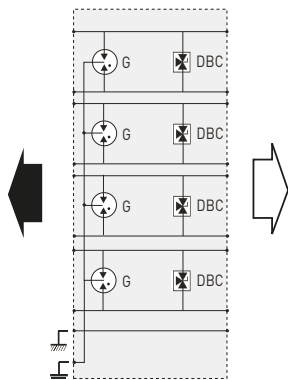

G : 3-electrode gas tube
DBC : 3-pole low capacitance diode



19" PATCH PANEL SURGE PROTECTOR

PL SERIES



PL24-CAT6

- Up to Gigabit Ethernet network
- 19" rack mounted
- 12 or 24 ports
- In/out: RJ45 shielded
- Gas tube/Diode diagram
- IEC 61643-21, EN 61643-21 and UL497A compliance

Characteristics

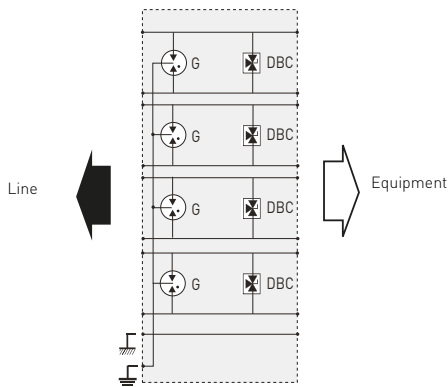
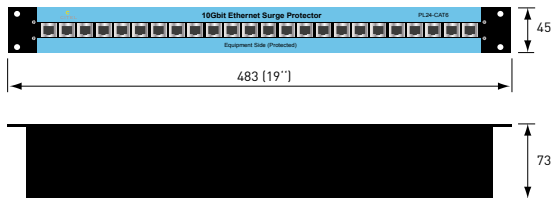

G: 3-electrode gas tube
 DBC : 3-pole low capacitance diode

CITEL Model	PL12-CAT6	PL24-CAT6
Description	19" patch panel surge protector for STP Ethernet 10Gigabit Ethernet Cat.6 cabling	19" patch panel surge protector for STP Ethernet 10Gigabit Ethernet Cat.6 cabling
Network		
Max. data rate	1 Gbps	1 Gbps
SPD configuration	12 ports of 8 wires	24 ports of 8 wires
Pin outs	(1-2)[3-6][4-5][7-8]	(1-2)[3-6][4-5][7-8]
Nominal line voltage	Un 5 Vdc	5 Vdc
Max. DC operating voltage	Uc 8 Vdc	8 Vdc
Max. Load current	IL 1000 mA	1000 mA
Max. frequency	f max 250 MHz	250 MHz
Insertion loss	< 1 dB	< 1 dB
Line/Ground Nominal discharge current - 8/20µs Test x 10 - category C2	In 2000 A	2000 A
Line/Line Nominal discharge current - 8/20µs Test x 10 - category C2	In 500 A	500 A
Protection level following C3 Category test - Line/Line	Up 20 V	20 V
Failsafe behavior	Short-circuit	Short-circuit
Mechanical characteristics		
Dimensions	see diagram	
Format	Rack 19"	
Connection to Network	RJ45 shielded female input/output	
End of life	transmission interrupt - default mode 2	
Spare unit	12-port PCB	
Mounting	Baie 19"	
Operating temperature	-40/+85°C	
Protection rating	IP20	
Housing material	Aluminium	
Standards		
Standards	IEC 61643-21 / EN 61643-21 / UL497A IEEE 802-3ab	
Part number		
	581534	581515

PCH SERIES



- 19" Rack mounted
- 12, 24 et 48 ports
- In/out: Connector type 110 / RJ45
- Available for Ethernet network and Telecom lines
- Possible maintenance per 2-line circuit
- Secondary protection
- IEC 61643-21 and UL497B compliance

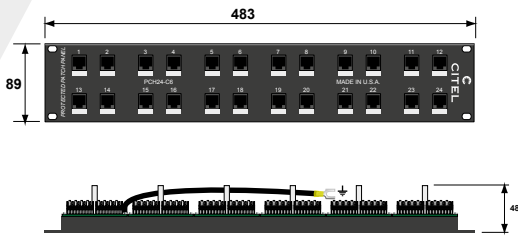

Surge protector circuit 2 lines

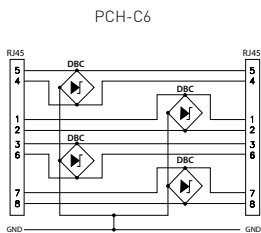
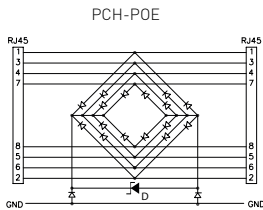
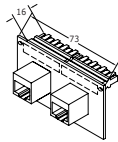

D : Clamping diode
 DBC : 3-pole low capacitance clamping diode

Characteristics

CITEL Model	PCH*-C6	PCH*-POE-A	PCH12-RJ45-G
Description	19" patch panel surge protector for UTP lines high-speed network		
Network	Gigabit Ethernet, RS422, RS485, Cat. 6	POE+, Gigabit Ethernet, Cat. 5	Telephone line, ADSL
Max. data rate	10 Gbps	1 Gbps	40 Mbps
SPD configuration	12, 24 or 48 ports with 8 wires	12, 24 or 48 ports with 8 wires	12 ports of 8 wires
Pin outs	{1-2}{3-6}{4-5}{7-8}	{1-2}{3-6}{4-5}{7-8}	{1-2}{3-6}{4-5}{7-8}
Nominal line voltage	Un 5 Vdc	48 Vdc	200 Vdc
Max. DC operating voltage	Uc 7.5 Vdc	60 Vdc	240 Vdc
Max. Load current	IL 750 mA	750 mA	750 mA
Max. frequency	f max 250 MHz	> 100 MHz	> 100 MHz
Insertion loss	< 1 dB	< 1 dB	< 1 dB
Line/Ground Nominal discharge current <i>8/20µs Test x 10 - C2 category</i>	In 500 A	250 A	350 A
Nominal discharge current Line/Line <i>8/20µs Test x 10 - C2 category</i>	In 500 A	250 A	350 A
Protection level <i>C3 Category test - Line/Line</i>	Up 20 V	20 V	300 V
Failsafe behavior	Short-circuit	Short-circuit	Short-circuit

Mechanical characteristics

Dimensions	see diagram
Format	Rack 19"
Connection to Network	Self-stripping connector 110 back/RJ45 female. front transmission interrupt - default mode 2
End of life	removable circuit 2 ports
Spare unit	19" rack panel
Mounting	19" rack panel
Operating temperature	-40/+85°C
Protection rating	IP20
Housing material	Aluminium

Standards

Compliance	IEC/EN 61643-21 / UL497B IEEE 802-3ab	IEC/EN 61643-21 / UL497B IEEE 802-3ab/3at	IEC/EN 61643-21 / UL497B
------------	--	--	--------------------------

Part number

12-port version	PCH12-C6	6249	PCH12-POE-A	6273	PCH12-RJ45-G	6350
24-port version	PCH24-C6	6251	PCH24-POE-A	6274	on request	-
48-port version	PCH48-C6	6252	PCH48-POE-A	6275	on request	-

* : 12, 24 or 48-port

19" PATCH PANEL SURGE PROTECTOR FOR HIGH-SPEED NETWORK

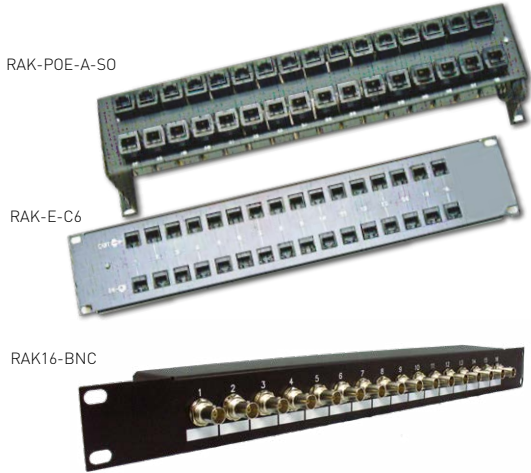

RAK SERIES

- 19" Rack mounted or Stand off (SO version)
- 16 or 32 ports
- In/out front: RJ45, BNC
- Available for Telecom and UTP Ethernet networks
- Possible maintenance per line
- Secondary protection
- IEC 61643-21 and UL497B compliance

Characteristics

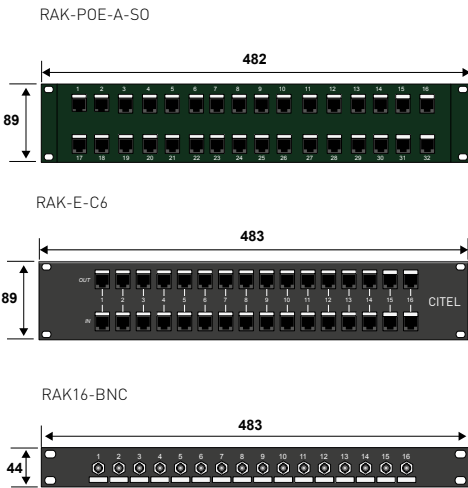

Surge protector circuit 1 line

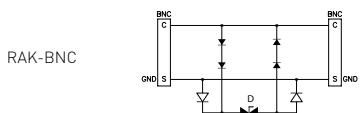
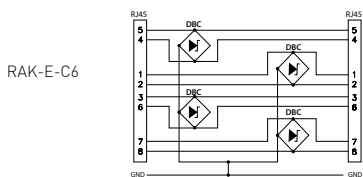
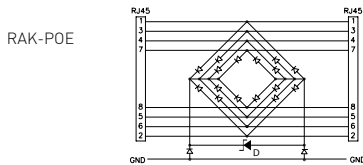
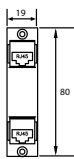

D : Clamping diode
DBC : 3-pole low capacitance clamping diode

CITEL Model	RAK*-E-C6	RAK*-POE-A	RAK16-BNC
Description	19" patch panel surge protector for UTP high-speed network		
Network	Gigabit Ethernet, RS422, RS485, Cat. 6	POE+, Gigabit Ethernet, Category 5	Video link
Max. data rate	1000 Mbps	1000 Mbps	1000 Mbps
SPD configuration	16 or 32 ports	16 or 32 ports	16 ports BNC
Pin outs	[1-2][3-6][4-5][7-8]	[1-2][3-6][4-5][7-8]	-
Nominal line voltage	Un 5 Vdc	48 Vdc	5 Vdc
Max. DC operating voltage	Uc 7.5 Vdc	60 Vdc	7.5 Vdc
Max. Load current	IL 750 mA	750 mA	750 mA
Max. frequency	fmax 250 MHz	> 100 MHz	> 100 MHz
Insertion loss	< 1 dB	< 1 dB	< 1 dB
Line/Ground Nominal discharge current	In 500 A	250 A	600 A
8/20µs Test x 10 - C2 category			
Nominal discharge current Line/Line	In 500 A	250 A	600 A
8/20µs Test x 10 - C2 category			
Protection level	Up 20 V	80 V	20 V
C3 Category test - Line/Line			
Failsafe behavior	Short-circuit	Short-circuit	Short-circuit
Mechanical characteristics			
Dimensions	see diagram		
Format	Rack 19"		
Connection to Network	RJ45 female input/output		BNC female input/output
End of life	transmission interrupt - default mode 2		
Spare unit	removable circuit 1 line		without
Mounting	19" rack or wall mounted (version SO)		
Operating temperature	-40/+85°C		
Protection rating	IP20		
Housing material	Aluminium		
Standards			
Compliance	IEC 61643-21 / EN 61643-21 / UL497B / IEEE 802-3ab	IEC 61643-21 / EN 61643-21 / UL497 B / IEEE 802-3ab/3at	IEC 61643-21 / EN 61643-21 / UL497B
Part number			
16-port version	RAK16-E-C6 6254	RAK16-POE-A 6372	RAK16-BNC 6253
32-port version stand-off	RAK32-E-C6-SO 6257	RAK32-POE-A-SO 891104	- -

* : 16 or 32-port

MSP-VM SERIES



MSP-VM120-2P

MSP-VM24

MSP-VM120-R

Characteristics

CITEL Model	MSP-VM Range		
	MSP-VM12	MSP-VM24	MSP-VM230
Description	Surge protector for video survey camera Power/Data/Video		
AC power specifications			
Network	12 Vac/Vdc	24 Vac/Vdc	230 V single phase
AC system	-	-	TT-TN
Protection mode(s)	CM/DM	CM/DM	CM/DM
Max. operating voltage	Uc 15 Vac/Vdc	30 Vac/Vdc	255 Vac
Max. Load current	IL 5 A	5 A	5 A
Residual current <i>Leakage current at Uc</i>	Ic None	None	None
Nominal discharge current	In 5 kA	5 kA	5 kA
Max. discharge current <i>max. withstand @ 8/20 μs by pole</i>	I _{max} 10 kA	10 kA	10 kA
Withstand on Combination waveform <i>Class III test</i>	Uoc 10 kV/5 kA	10 kV/5 kA	10 kV/5 kA
Protection level	Up 0.22 kV	0.22 kV	1.2 kV
End of life	Green LED OFF and line cut-off		
Connection to Network	screw terminal 2.5 mm ² max		
Standards compliance	IEC 61643-11 / EN 61643-11 / UL1449 ed.4		
Dataline specifications			
Network	1 pair signal 0-5 V	1 pair signal 0-5 V	1 pair signal 0-5 V
Max. operating voltage	Uc 8 Vdc	8 Vdc	8 Vdc
Max. Load current	IL 300 mA	300 mA	300 mA
Max. frequency	f max 10 MHz	10 MHz	16 MHz
Insertion loss	< 1dB	< 1dB	< 1dB
Nominal discharge current	In 2.5 kA	2.5 kA	2.5 kA
Max. discharge current <i>max. withstand @ 8/20 μs by pole</i>	I _{max} 5 kA	5 kA	5 kA
Protection level	Up 20 V	20 V	20 V
End of life	interruption of transmission - default mode 2		
Connection to Network	screw terminal 1.5 mm ² max		
Standards compliance	IEC 61643-21 / EN 61643-21		
Videoline specifications			
Network	signal video	signal video	signal video
Max. operating voltage	Uc 6 Vdc	6 Vdc	6 Vdc
Max. Load current	IL 300 mA	300 mA	300 mA
Max. frequency	f max 100 MHz	100 MHz	100 MHz
Insertion loss	< 1dB	< 1dB	< 1dB
Nominal discharge current	In 5 kA	5 kA	5 kA
Max. discharge current <i>max. withstand @ 8/20 μs by pole</i>	I _{max} 10 kA	10 kA	10 kA
Protection level	Up 20 V	20 V	20 V
End of life	interruption of transmission - default mode 2		
Connection to Network	connector BNC female		
Standards compliance	IEC 61643-21 / EN 61643-21		
Mechanical characteristics			
Dimensions	see diagram		
Mounting	DIN rail or plate (flange)		
Operating temperature	-40/+85°C		
Protection rating	IP20		
Housing material	anodized aluminum		
Part number	420403	420402	420401

MSP-VM

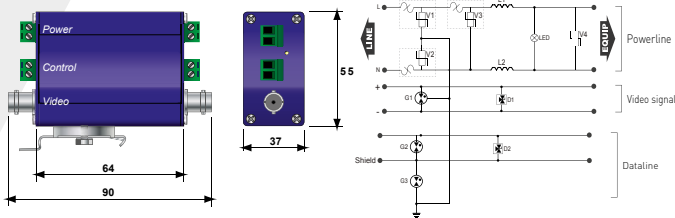

MSP-VM-2P

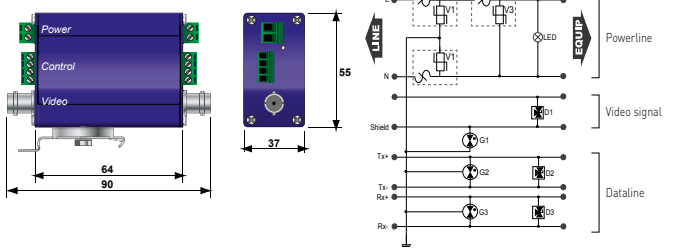

MSP-VM-R

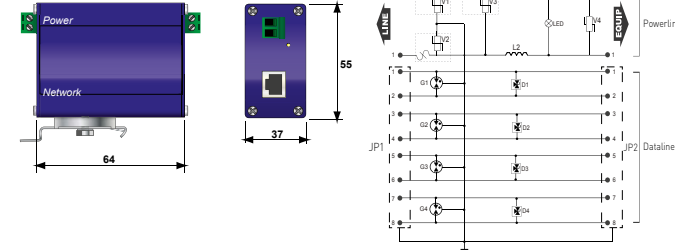

D : Clamping diode
G : Gas tube
V : Varistor
LED : Indicator
L : Inductor



DD SERIES

- “D-Sub” surge protectors
- For RS232, RS422, RS485 communication lines
- Fast and easy installation
- 9, 15 and 25-pin connectors
- Secondary protection
- IEC 61643-21, EN 61643-21 and UL497B compliance

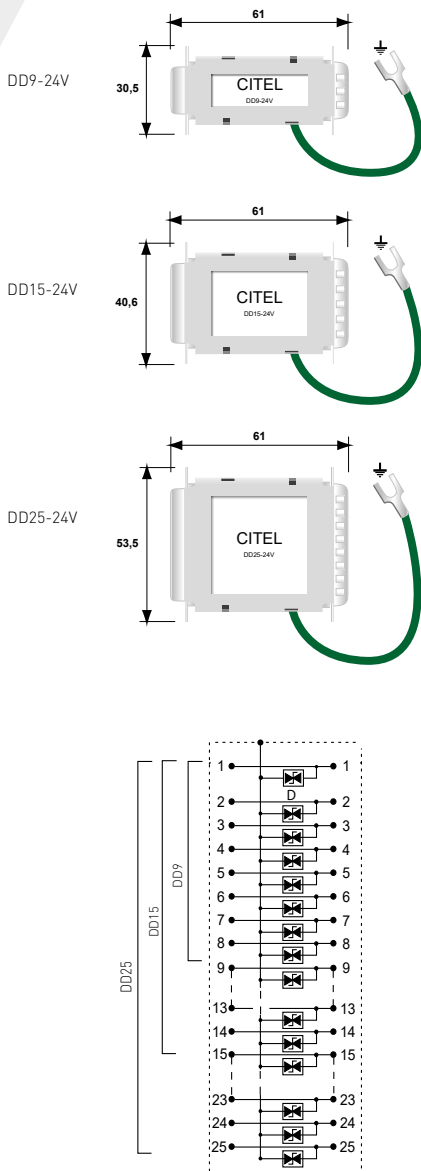

Characteristics

CITEL Model	DD*-24V	DD*-6V		
Description	D-sub dataline surge protector			
Network	RS232, RS485, 4-20mA	RS422, RS423		
Max. data rate	< 40 Mbps	< 40 Mbps		
SPD configuration	9, 15 or 25-pin connector	9, 15 or 25-pin connector		
Pin outs	all wires transmitted and protected			
Nominal line voltage	Un	12 Vdc		
Max. DC operating voltage	Uc	15 V		
Max. Load current	IL	750 mA		
Max. frequency	f max	> 10 MHz		
Insertion loss		< 1 dB		
Line/Ground Nominal discharge current - 8/20µs Test x 10 - C2 category	In	300 A		
Line/Line Nominal discharge current - 8/20µs Test x 10 - C2 category	In	300 A		
Protection level following C3 Category test - Line/Line	Up	18 V		
Failsafe behavior	Short-circuit	Short-circuit		
Mechanical characteristics				
Dimensions	see diagram			
Mounting	in/out D-Sub connector unit			
End of life	transmission interrupt - default mode 2			
Mounting	on cable			
Operating temperature	-40/+85°C			
Protection rating	IP20			
Housing material	Thermoplastic UL94 V-0			
Standards				
Compliance	IEC 61643-21 / EN 61643-21 / UL497B			
Part number				
25-pin connector male/female	DD25-24V	6145	DD25-6V	891725
15-pin connector male/female	DD15-24V	6214	DD15-6V	6144
9-pin connector male/female	DD9-24V	6147	DD9-6V	6148

* : 9, 15 or 25-pin

D : Clamping diode

CXC - CNP



CXC06-B/MF



CNP06-B/FM

- F or BNC connectors
- Low insertion loss
- Easy installation
- IEC 61643-21, EN 61643-21 and UL497C/E compliance

Characteristics

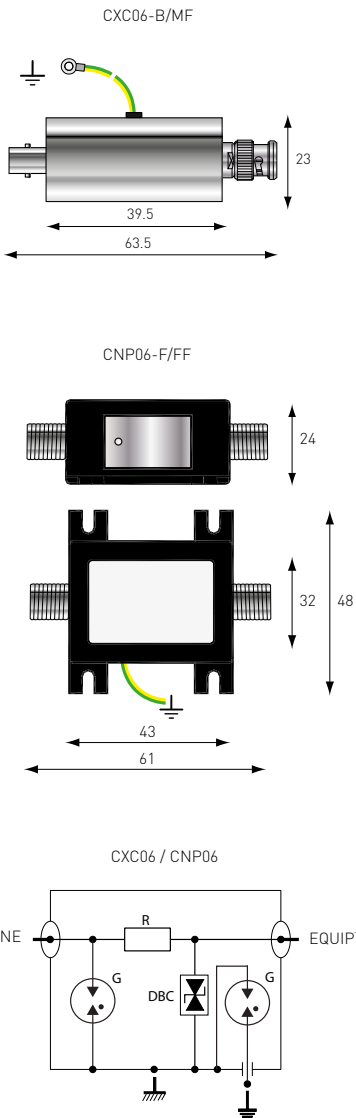

G: 2-electrode gas tube
 DBC : Low capacitance diode
 R : Resistor

CITEL Model	CXC06*	CNP06*		
Description	Coaxial surge protector for video transmission networks			
Technology	GDT + Diode	GDT + Diode		
Max. frequency	f	DC - 70 MHz	DC - 100 MHz	
Max Power	P	6 W	4 W	
Impedance	Z	50/75 ohms	50/75 ohms	
Insertion loss		≤ 0.6 dB	≤ 0.5 dB	
Return loss		≥ 20 dB	> 20 dB	
VSWR		< 1.3:1	< 1.3:1	
Max. Load current	IL	0.5 A	0.5 A	
Nominal discharge current	In	5 kA	5 kA	
<i>8/20µs Test x 10 - C2 Category</i>				
Max. discharge current	Imax	10 kA	20 kA	
<i>max. withstand @ 8/20 µs by pole</i>				
Impulse current	Iimp	2.5 kA	2.5 kA	
<i>2 x 10/350µs Test - D1 Category</i>				
Protection level	Up	25 V	20 V	
<i>following C3 Category test - Line/Line</i>				
Failsafe behavior		short-circuit	short-circuit	
Mechanical characteristics				
Dimensions	see diagram			
Connection to Network	BNC or F connector			
End of life	transmission interrupt - default mode 2			
Mounting	on cable	on plate		
Operating temperature	-40/+85°C			
Protection rating	IP20			
Housing material	Brass	Metal+plastic		
Standards				
Compliance	IEC 61643-21 / EN 61643-21 / UL497C / UL497E			
Part number				
BNC connector Female/Male	CXC06-B/FM	6301341	CNP06-B/FM	64270
BNC connector Male/Female	CXC06-B/MF	630134	CNP06-B/MF	632611
F connector Female/Female	-	-	CNP06-F/FF	632602
F connector Male/Female	-	-	CNP06-F/MF	632601

*1) BNC or F, Male/Female or Female/Female connector



CITEL



COAXIAL RF SURGE PROTECTORS

RF SURGE PROTECTION OR RF COAXIAL SPD

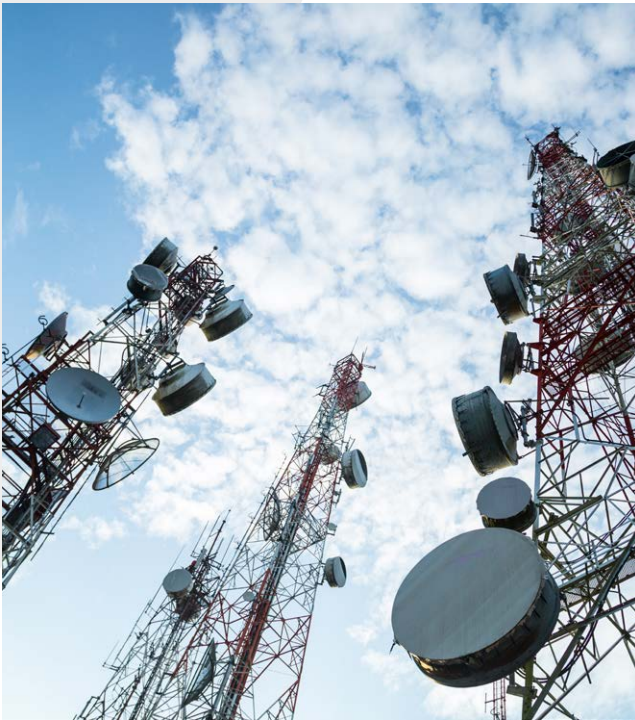

PROTECTION OF RADIO COMMUNICATION EQUIPMENT

Radio communication equipment deployed in fixed, nomadic or mobile applications are especially vulnerable to lightning strikes because of their application in exposed areas. The most common disruption to service continuity results from transient surges originating from direct lightning strikes to the antenna pole, surrounding ground system or induced onto connections between these two areas.

Radio equipment utilized in CDMA, GSM/UMTS, WiMAX or TETRA base stations, must consider this risk in order to insure uninterrupted service. CITEL offers three specific surge protection technologies for Radio Frequency (RF) communication lines that are individually suited for the different operational requirements of each system (Filter, GDT and quarter wave).

RF SURGE PROTECTION TECHNOLOGY

P8AX series (Gas Tube Protection)

The gas discharge tube (GDT) is the only surge protection component usable on very high frequency transmission (several GHz) due to its very low capacitance. In a coaxial surge protector, the GDT is connected in parallel between the central conductor and the external shield. When its sparkover voltage is reached, during an overvoltage event, the line is briefly shorted (arc voltage). The sparkover voltage depends on the rise front of the overvoltage. The higher the dV/dt of the overvoltage, the higher the sparkover voltage of the surge protector is.

When the overvoltage disappears, the gas discharge tube returns to its original condition of high isolation and is ready to operate again. The gas tube is removable, making maintenance rapid in the end-of-life scenario (short-circuit).

The greatest advantage of this technology is its very wide bandwidth: from DC (so, compatible with DC voltage injection) to several GHz.

Main characteristics:

- » Insertion losses < 0,2 dB
- » VSWR < 1,2
- » I_{max} : 20 kA (8/20 μ s)
- » Frequency range from DC to 7 GHz
- » Connectors : 7/16, 4.3-10, N, TNC, BNC, SMA, F, UHF
- » Waterproof IP65

Main characteristics VG option:

- » I_{max} : 6 kA (8/20 μ s)
- » Connector : 4.3-10, N, F
- » Prevents the short-circuit of the transmitter (output) and the receiver (input) during a disturbance

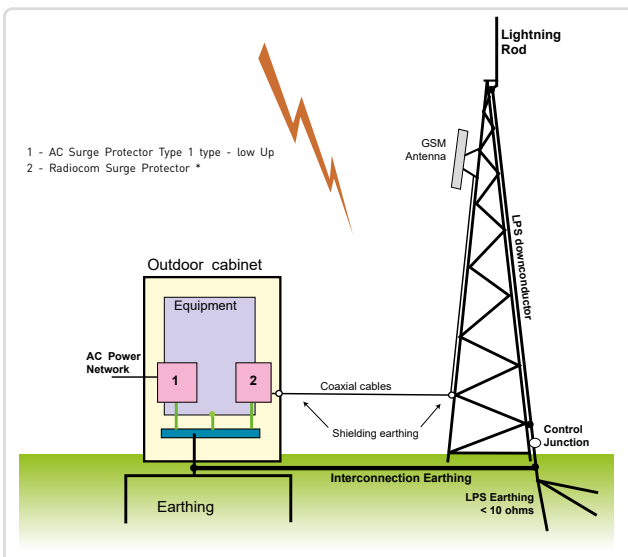
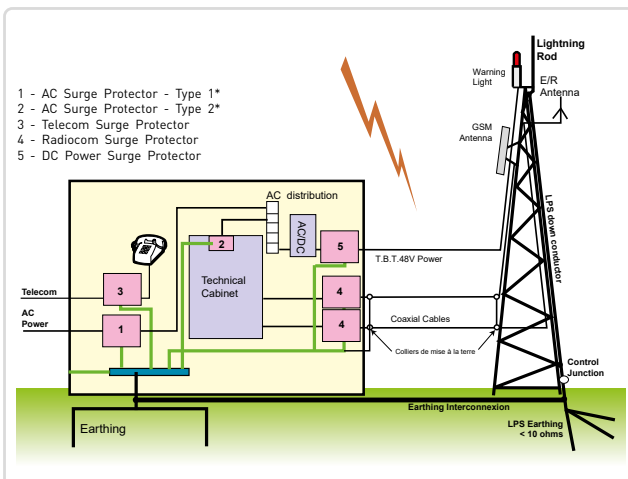

* Type referring to IEC standards

CNP/CXP series (GDT protection) and CXP-DCB series (DC Blocked Protection)

CXP protectors are based on GDT to provide high discharge current capability without destruction. These type of products allows for installation in ungrounded systems. In these cases, the CXP isolates the shield from the earth ground and is typically found in applications including wireless radio terminals and TV monitors (antenna, cable or satellite).

CXP-DCB version is a relevant hybrid association between a filter stage and a gas tube : this configuration has the advantage of reducing low frequency disturbances (DC and lightning voltages) while providing a high discharge current capability.

Main characteristics (CXP):

- » isolated ground through GDT
- » Insertion losses < 0.5 dB
- » VSWR < 1.3
- » I_{max} : 20 kA (8/20µs)
- » Frequency range from DC to 1000 MHz
- » Connectors : N, BNC, SE, F...

Main characteristics (CXP-DCB):

- » "DC Block" feature
- » Insertion losses < 0.15 dB
- » VSWR < 1.2
- » I_{max} : 10 kA (8/20µs)
- » Frequency range from 125 MHz to 1000 MHz
- » Connectors : N, BNC

PRC series (Quarter Wave Protection)

Quarter Wave DC Blocked Protection is an active band pass filter. It has no active components. Rather the body and corresponding stub are tuned to one quarter of the desired wave length. This allows only specific frequency bands to pass through the unit. Since lightning operates only on a very small spectrum, from a few hundred kHz to a few MHz, it and all other frequency's are short-circuited to ground. The filter may be selective (narrow band or wide-band), according to the calculation of various mechanical elements.

The PRC technology can be selected with very narrow band or wide band depending on the application. Surge current withstand is the depending on connector type. Typically, a 7/16 Din connector can handle 100kA 8/20µs while an N-type connector can handle up to 50kA 8/20µs.

AC/DC power injection is not possible with this technology typical application is the protection of radio lines that do not have a source voltage

Main characteristics :

- » Insertion losses < 0.2 dB
- » VSWR < 1.2
- » Broadband and narrowband units available
- » Frequency range:
 - 690-2700 MHz
 - 800-2200 MHz
 - 400-500 MHz
 - 870-950 MHz
 - 1700-1950 MHz
 - 1800-2400 MHz
 - 4800-6000 MHz
- » Best PIM performance: less than 160 dBc with 4.3-10 connector
- » I_{max} : up to 100 kA (8/20µs)
- » Connectors : 7/16, N, BNC, TNC, 7/8 cable

RF SURGE PROTECTORS DIAGRAMS

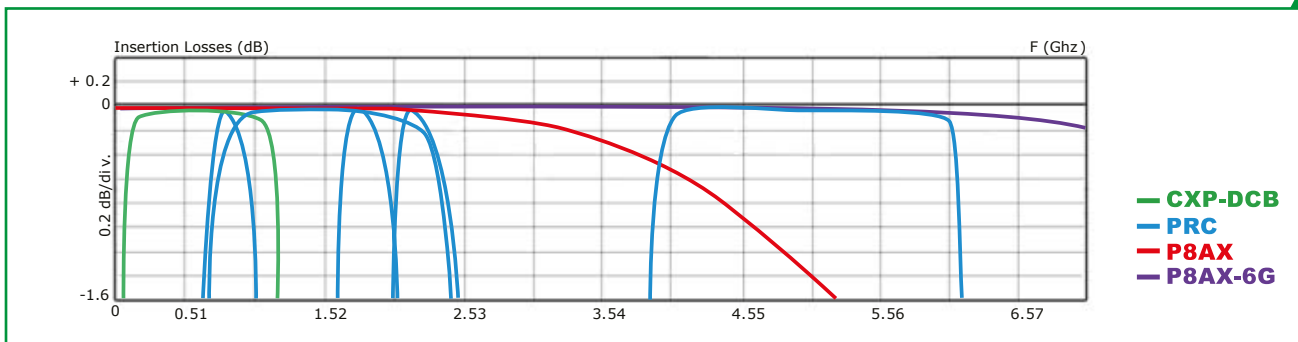
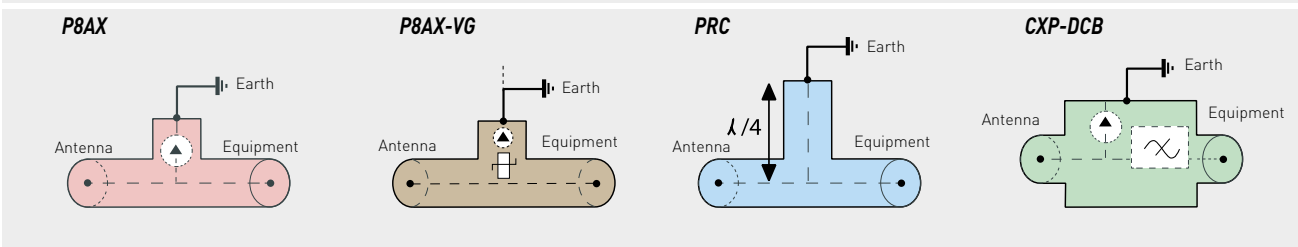

RF SURGE PROTECTION or RF COAXIAL SPD

COAXIAL SPD SPECIFIC PARAMETERS

RF transmission parameters

Coaxial protectors are intended to pass through a desired RF signal with minimum loss or disturbance. When RF energy enters a protector, the energy is, in some combination, passed through, reflected back, and dissipated within the device. The fundamental RF performance parameters of a coaxial protector are:

- Operation frequency range
- Insertion Loss : the loss in load power due to the insertion of the coaxial protector, measured in decibels (dB)
- Return Loss : part of signal which is lost due to reflection of power at a line discontinuity or mismatched coaxial protector, in decibels (dB)
- VSWR : Voltage standing Wave Ratio – ratio of U_{max}/U_{min} on a RF transmission line
- PIM (Passive Intermodulation) : non-linear characteristics of coaxial protectors cause undesirable signals by modulation effects in the case of several carriers being transmitted.

Connectors Surge current parameters

- General parameter from standard (I_n , I_{max} , I_{imp} refer to standards)
- Let-Through Energy :
Energy through the surge protector when a standardized impulse is applied to the input. In most cases the input is a combination wave 4kV 1.2/50 μ s – 2kA 8/20 μ s. The output of the protector is burdened by 50 Ω , and the resulting waveform is measured. The let-through energy, in Joules, is calculated from the peak voltage/current and integrated pulse width across the load.

F_Female



F_Male



P8AX09-6G-4310-FF



716_Male



BNC_Female



BNC_Male



N_male_female



716_Female



TNC_Female



TNC_Male



SMA_male_female.png



4.3-10_Female



4.3-10_Male



SPD TECHNOLOGIES COMPARISON

Table below allows comparison between the 3 technologies of RF coaxial surge protectors, in order to select the right solution regarding the application and the requirements.

Technology	Gas Discharge Tube (GDT)	DC Block	Quarter wave (1/4)
CITEL series	P8AX	CXP-DCB	PRC
			
Principle	Switching	Switching + Filter	1/4 wave filter
Residual voltage (under standardized test condition: 1kV/μs surge voltage and/or surge current [8/20μs])	Depending on version, it can be from 600V to 2400V for typically 200 ns and then 10V during surge current flowing time.	Less than 600V for typically 200 ns and then 0V during surge current flowing time.	< 20 V during all surge duration.
Frequency range	DC up to 7 GHz (dependent on the coaxial connector and the impedance)	125-1000 MHz	Broadband and narrow band (GSM, DCS1800, PCS, DECT, GPS....) up to 5800 MHz
DC/AC power injection	Possible	Blocked	Not compatible
Typical 8/20μs surge current capability	20 kA	20 kA	Depending on the connector: 100kA for the 7/16, 50kA for the N
Typical 10/350μs lightning current capability	2.5 kA	2.5 kA	Function of the connector : 25kA to 50kA
Typical let through energy (on 50 Ohms load for 4kV/2kA combined surge)	300μJ	300μJ	5μJ
Maintenance	Possible to replace the GDT (but not recommended)	None	None
End of life detection	RF line shorted	RF shorted	No end of life excepted due to environmental stress
Connectors	N, BNC, TNC, UHF, SMA, 7/16, 4.3-10 option VG : 4.3-10, N, F	N, BNC, TNC.	7/16, N, TNC, 4.3-10....

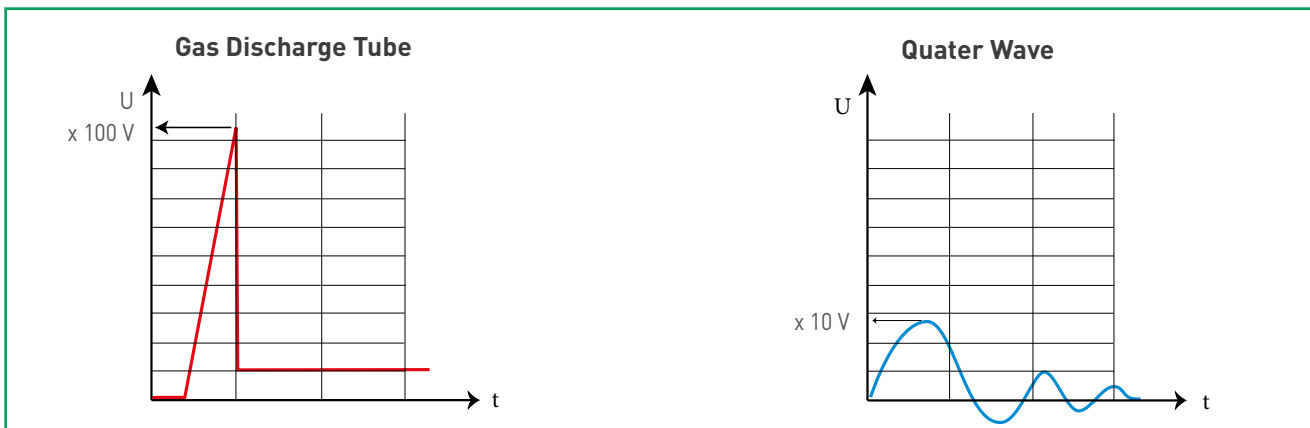

RF SURGE PROTECTION or RF COAXIAL SPD

TYPICAL RADIO FREQUENCY BANDS

LF : Low Frequency	30-300 kHz
MF : Medium Frequency	300-3000 kHz
HF : High Frequency	3-30 MHz
VHF : Very High Frequency	30-300 MHz
UHF : Ultra High Frequency	300-3000 MHz
SHF : Super High Frequency	3-30 GHz

A FEW MICROWAVE APPLICATIONS

Tetra, Tetrapol	380-512 MHz
GSM850	824-894 MHz
Tetra	870-925 MHz
GSM 900	880-960 MHz
GPS	1575 MHz
GSM 1800	1710-1785 MHz
GSM 1900	1850-1990 MHz
DECT	1880-1900 MHz
WCDMA/TD-SCDMA	1850-2025 MHz
UMTS (IMT-2000)	1885-2200 MHz
WLL (WiMax)	2400-5825 MHz

INSTALLATION, LOCATION OF THE SPD

The efficiency of coaxial protectors is highly dependent on proper installation, in particular their connection to the earthing network of the installation.

The following installations rules must be strictly observed to ensure the efficiency:

- » Equipotential bonding network: all the bonding conductors of the installation must be interconnected and connected to the installation earthing network.
- » Optimized connection of the protector to the bonding network: to reduce the residual voltages during lightning discharge currents, the connection of the protector to the bonding network must be as short as possible (less than 50 cm) and has a proper cross section (at least 4 mm²).
The «feedthrough mounting» versions perfectly meet all these requirements.
Warning: Carefully remove all paintings or insulating coatings to ensure good contact..
- » Location of the protectors: they should preferably be placed at the entrance of the installation (to limit the penetration of lightning currents) and also near sensitive equipment (to enhance protection).

MOUNTING

The proper mounting of a coaxial surge protector is largely dependent on its connection to a low impedance grounding system. The following rules must be strictly observed:

Equipotential Grounding System: All the bonding conductors of the installation must be interconnected to each other and connected back to the grounding system.

Low Impedance Connection: The coaxial surge protector needs to have a low resistance connection to the Ground System.

Note: Depending on models, CITELE Coaxial SPD's family is suitable to be mounted outdoor and can be immersed as soon as the connection to the cable is realized to be immerse as well.

Feedthrough mounting

Direct mounting of the surge protector on the grounded frame at the installation entrance (or on specific bracket see p. 177) :

- » Perfect connection to the bonding network
- » Best location (conduction of the surge currents at the entrance of the installation)
- » Good mechanical withstand.

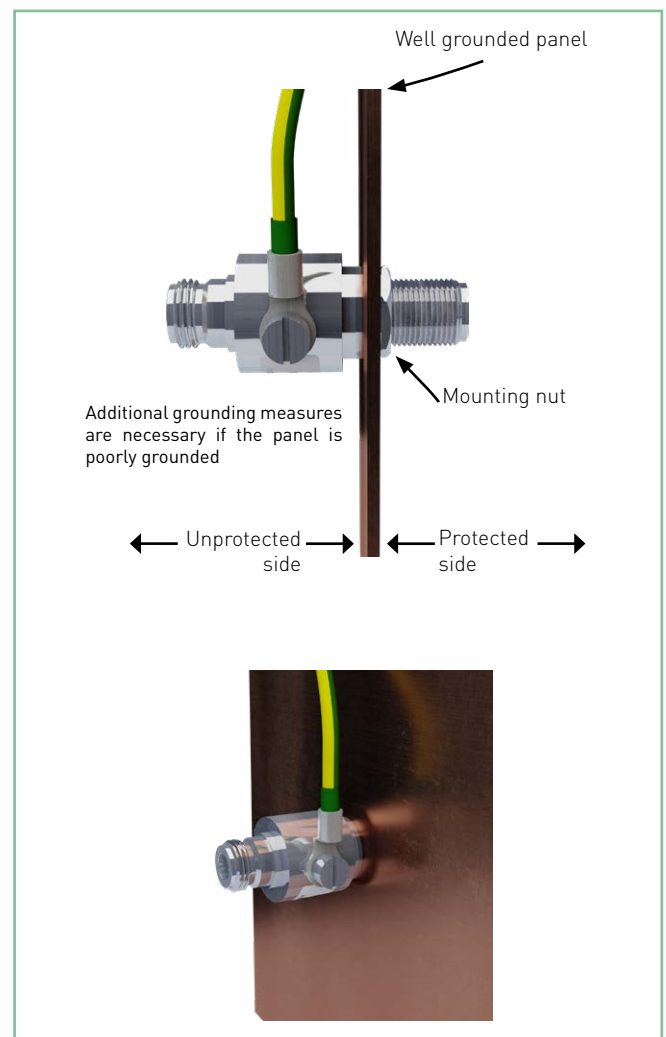

Note: Unprotected side and Protected side concept is a recommendation to keep the box concept principle but surge protection is bidirectional

Alternative mounting

Connection to the bonding network by wire (4 mm² minimum and shortest length possible).

STANDARDS

Various standards address Coaxial surge protection . CITELE SPD are designed to be compliant with the following:

IEC 61643-21 : Low voltage surge protective devices – Part 21: Surge protective devices connected to telecommunications and signaling networks – Performance requirements and testing methods

EN 61643-21: Low voltage surge protective devices – Part 21: Surge protective devices connected to telecommunications and signaling networks – Performance requirements and testing methods

UL497C : Protectors for Coaxial Communications Circuits

UL497E : Outline Of Investigation For Protectors For Antenna Lead-In Conductors

SPD SELECTION

Peak power and connectors

Peak power is the maximum transmitted power that the SPD can handle without damage or unwanted action.

The connector is mainly set by the installation. The characteristic Impedance of the SPD is often linked to a specific type of connector but it may happen that a connector type exists with 2 different impedances (50 ohms and 75 ohms are possible with BNC connector).

For PRC range, the admissible peak power is depending on the connector. See declared values in dedicated datasheet.

For P8AX, CXC, CXP ranges, the admissible peak power is linked

- to the nominal spark over voltage: of the selected GDT,
- to the VSWR,
- to the possible injected ac/dc power,
- to the Impedance and
- to the connector type (not big impact for P8AX).

Following tables are showing how to select both PA8X spark over voltage of the GDT for 50 ohms with no injected ac/dc power and Connector selection. For CXP and CXC ranges, the selection principal is similar to P8AX range, and details are provided on various datasheets in the following pages.

CITEL model	Nominal sparkover voltage	Max. peak power with	
		VSWR<1.2	VSWR <1.5
P8AX09	90 V	25 W	24 W
P8AX15	150 V	70 W	67 W
P8AX25	250 V	190 W	188 W
P8AX50	500 V	780 W	762 W

CITEL model	Connectors
P8AX-716	7/16
P8AX-4310	4.3-10
P8AX -N	N
P8AX - T	TNC
P8AX -B	BNC
P8AX -SMA	SMA
P8AX -F	F
P8AX -U	UHF

When ac/dc power is injected, special care must be applied. As an example, if 48V dc power is superimposed with RF signal a P8AX25 is limited to 114W for VSWR ≤ 1,2. Consult our experts for further information.

REFERENCE SYSTEM

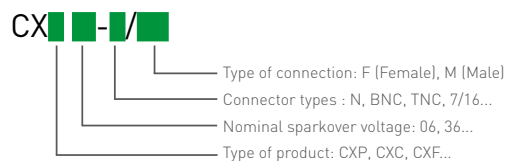
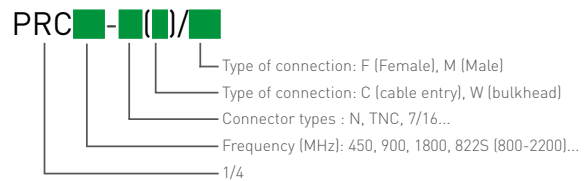
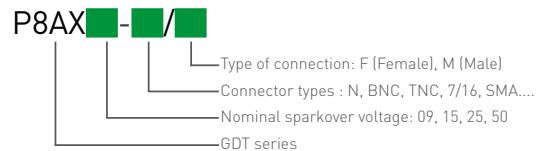

RF SURGE PROTECTION or RF COAXIAL SPD

EXAMPLE FOR SPECIFIC REQUIREMENT USING A PRC827-N/MF

Main features description of the Quarter-Wave Surge Protector used for the example



- » Maintenance Free Design
- » Low Insertion Loss
- » Several Wide to Narrow Band Applications
- » $I_{max} > 50kA$, Peak power = 1,5kW, $Z = 50\Omega$
- » IP66 Classification
- » DC Block (Short Circuit)

To select the proper RF protection, the main point is to know exactly what will be the frequency of use and the minimum transmission characteristic that the system is able to accept for proper communication. The full system must then be known as each single element of the system is willing to disturb or attenuate the RF signal. Connectors, cable and any other components or equipment that is comprised in this system must be considered. In general a VSWR lower than 1.2 is more than acceptable for a system to work properly this is why the wide band for single RF equipment is limited by the frequencies that are corresponding to this ratio. In some extreme case, the specific need is to get lower VSWR for the full system. It is mandatory to optimize each single equipment because each losses is simply cumulated along the transmission line (Coaxial cable equipped with various equipment such as SPDs). For this example, the hereunder plots made on our PRC827-N/MF, are showing transmission characteristics depending on frequencies that are better or even much better than general declared values.

In such specific needs, the Surge protection must be selected in regard to the working frequency band.

Note: in general all RF characteristics for a device are linked and vary in the same way depending on the frequency.

In our example, if the requested working frequency band is 2.7 GHz to 2.72 GHz, the selected SPD is presenting exceptional RF characteristics in this frequency range (VSWR<1,05) even if general features state that VSWR is between 1 and 1,2 from 0,8 GHz to 2,8GHz.

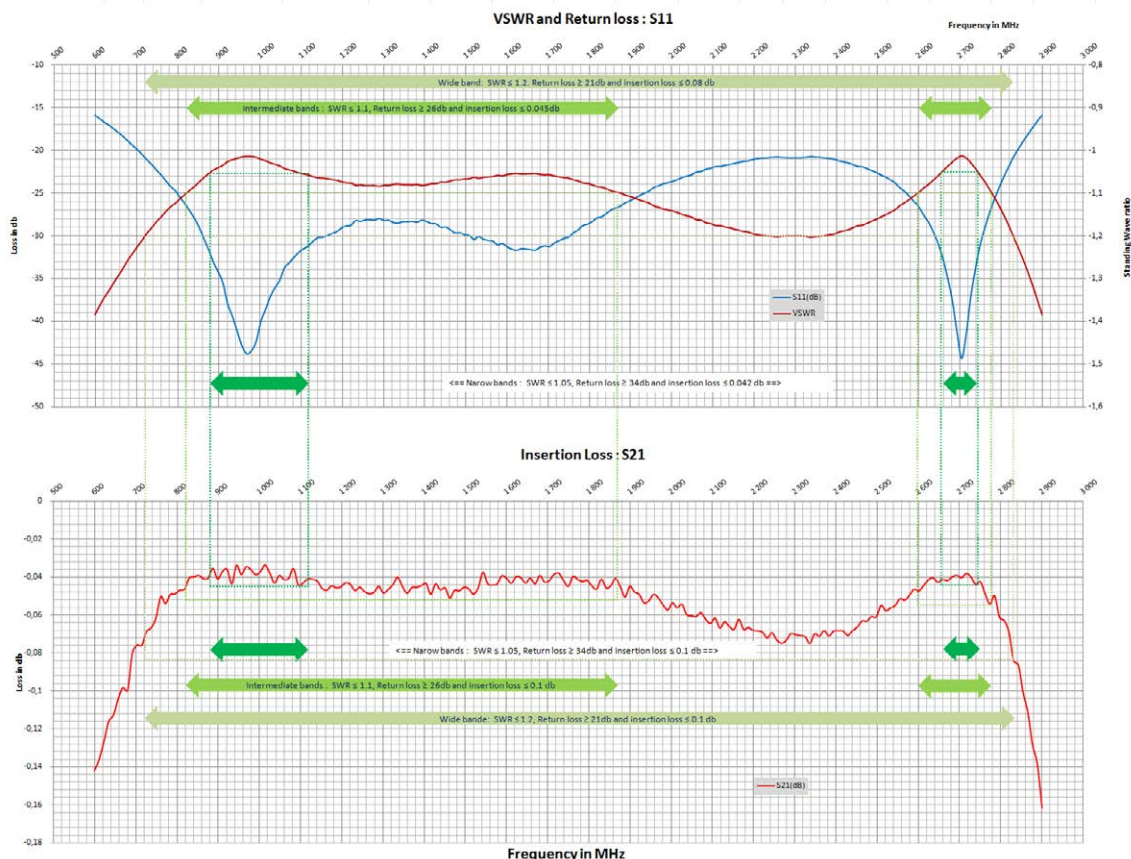

Another presentation format is shown in the following table.

Frequency band		Wide	Intermediate low	Intermediate high	Narrow low	Narrow high
	(MHz)	720-2830	820-1970	2600-2780	880-1120	2655-2745
VSWR	-	< 1.2	< 1.1		< 1.05	
Return loss	(dB)	> 21	> 26		> 34	
Insertion loss	(dB)	< 0.09	< 0.045		< 0.042	

In general wide band characteristics provided are sufficient for good selection of SPDs and for general application. Specific characteristics are available on request for specific frequencies.



P8AX09-N/MF

P8AX SERIES

- Low insertion losses
- Waterproof
- Removable GDT
- DC-pass
- Bi-directional protection

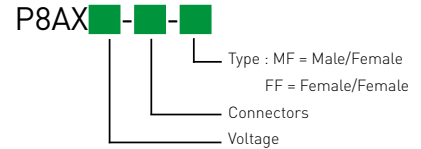

Characteristics

CITEL Model	P8AX09*	P8AX15*	P8AX25*	P8AX50*				
Description	RF coaxial protector - 3.5 GHz							
Technology	Gas discharge tube	Gas discharge tube	Gas discharge tube	Gas discharge tube				
Frequency range	f DC-3.5GHz	DC-3.5GHz	DC-3.5GHz	DC-3.5GHz				
Max Power	P 25 W	70 W	190 W	780 W				
Impedance	Z 50/75 ohms	50/75 ohms	50/75 ohms	50/75 ohms				
Insertion loss	< 0.2dB	< 0.2dB	< 0.2dB	< 0.2dB				
Return loss	> 20 dB	> 20 dB	> 20 dB	> 20 dB				
VSWR	<1.2:1	<1.2:1	<1.2:1	<1.2:1				
Max. Load current	IL 10A	10A	10A	10A				
Nominal discharge current - 8/20µs Test x 10 - C2 Category	In 5 kA	5 kA	5 kA	5 kA				
Max. discharge current - max. withstand @ 8/20 µs by pole	Imax 20 kA	20 kA	20 kA	20 kA				
Impulse current - 2 x 10/350µs Test - D1 Category	Iimp 2.5 kA	2.5 kA	2.5 kA	2.5 kA				
Protection level @ 1kV/µs - C3 Category	Up < 650 V	< 700 V	< 800 V	<1200 V				
Typical let through energy [50 ohms] input 4kV 1.2/50µs - 2kA 8/20µs	300 µJ	320 µJ	350 µJ	1100 µJ				
End of life behavior	Short-circuit (fault mode 2 - Transmission interruption)							
Mechanical characteristics								
Dimensions	see diagram							
Connection to Network	N . TNC. SMA. F. BNC. 7/16, 4,3-10							
Disconnection indicator	transmission interrupt							
Mounting	Feedthrough							
Operating temperature	-40/+85°C							
Protection rating	IP66							
Housing material	Brass/Surface plating: Cu Zn Sn							
Contacts	Bronze/Surface plating: Au or Ag							
Insulation material	PTFE							
RohS compliance	yes							
Spare unit	BBHF-90V	BBHF-150V	BBHF-250V	BBHF-500V				
Standards								
Compliance	IEC 61643-21 / EN 61643-21 / UL497C / UL497E							
* Part number								
BNC connector Female/Female	P8AX09-B/FF	60111	P8AX15-B/FF	60112	P8AX25-B/FF	60114	P8AX50-B/FF	60117
BNC connector Male/Female	P8AX09-B/MF	60101	P8AX15-B/MF	60102	P8AX25-B/MF	60104	P8AX50-B/MF	60107
N connector Female/Female	P8AX09-N/FF	60011	P8AX15-N/FF	60012	P8AX25-N/FF	60014	P8AX50-N/FF	60017
N connector Male/Female	P8AX09-N/MF	60001	P8AX15-N/MF	60002	P8AX25-N/MF	60004	P8AX50-N/MF	60007
F connector Female/Female	P8AX09-F/FF	60211	P8AX15-F/FF	60212	P8AX25-F/FF	60214	P8AX50-F/FF	-
F connector Male/Female	P8AX09-F/MF	60201	P8AX15-F/MF	-	P8AX25-F/MF	60204	P8AX50-F/MF	-
SMA connector Female/Female	P8AX09-SMA/FF	60511	P8AX15-SMA/FF	60512	P8AX25-SMA/FF	60514	P8AX50-SMA/FF	-
SMA connector Male/Female	P8AX09-SMA/MF	60501	P8AX15-SMA/MF	60502	P8AX25-SMA/MF	60504	P8AX50-SMA/MF	-
7/16 connector Male/Female	P8AX09-716/MF	60401	P8AX15-716/MF	-	P8AX25-716/MF	60404	P8AX50-716/MF	60407
7/16 connector Female/Female	P8AX09-716/FF	60411	P8AX15-716/FF	-	P8AX25-716/FF	60414	P8AX50-716/FF	60417
4.3-10 connector Male/Female	P8AX09-4310/MF	-	P8AX15-4310/MF	-	P8AX25-4310/MF	-	P8AX50-4310/MF	-
4.3-10 connector Female/Female	P8AX09-4310/FF	-	P8AX15-4310/FF	-	P8AX25-4310/FF	-	P8AX50-4310/FF	-

Note : If no ordering code, please contact us for more information

RF COAXIAL PROTECTORS - 3.5 GHZ

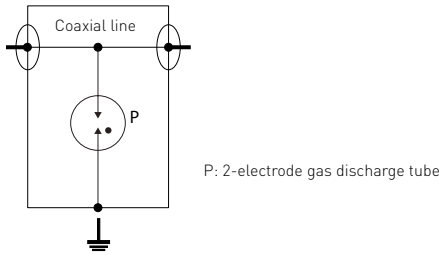

P8AX_-B/FF

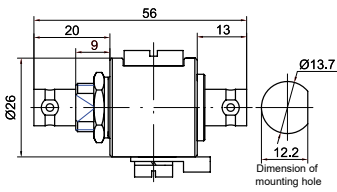

P8AX_-B/MF

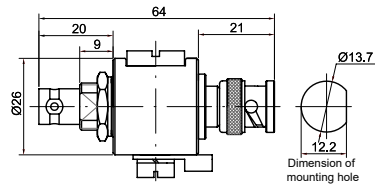

P8AX_-N/FF

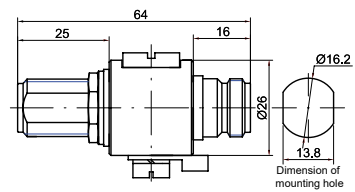

P8AX_-N/MF

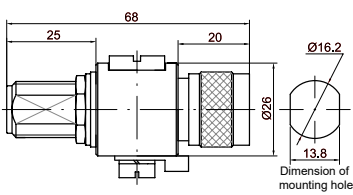

P8AX_-F/FF

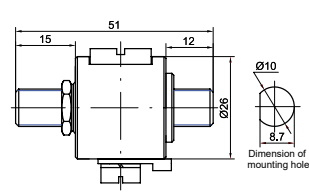

P8AX_-F/MF

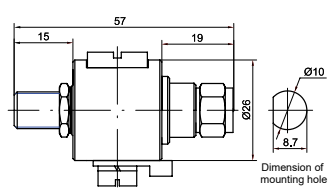

P8AX_-SMA/FF

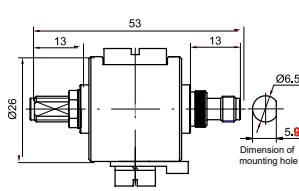

P8AX_-SMA/MF

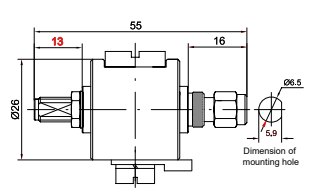

P8AX_-716/FF

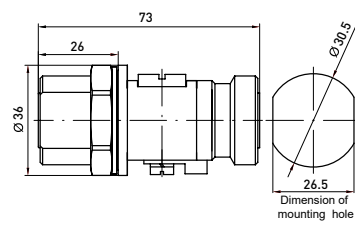

P8AX_-716/MF

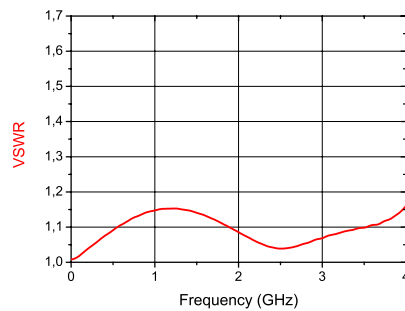
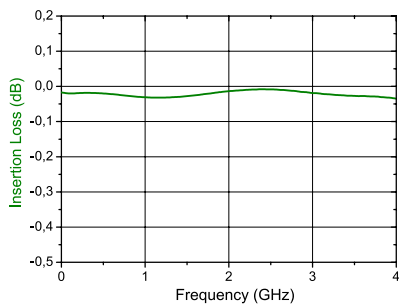
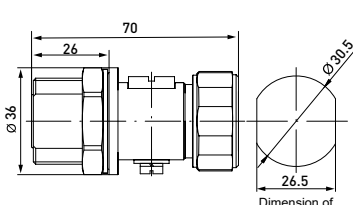



P8AX09-6G-N/MF

P8AX-6G SERIES



- Low insertion losses
- Waterproof
- Removable GDT
- DC-pass
- Bi-directional protection

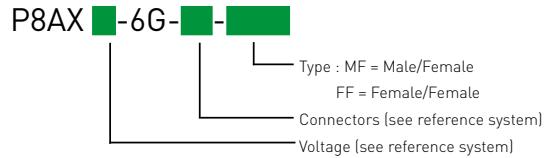

Example: P8AX-6G-N/MF

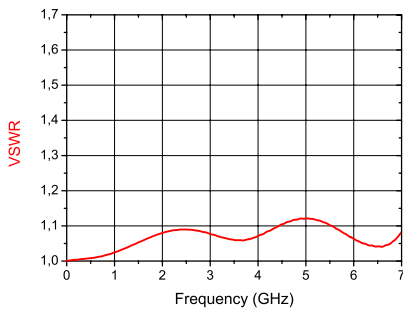
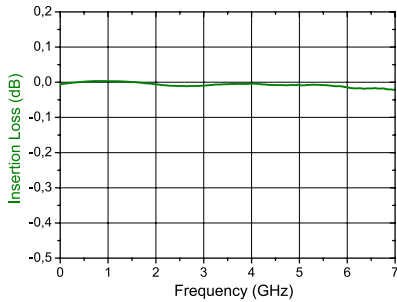
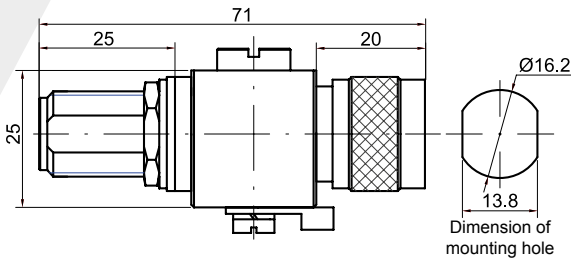

Characteristics

CITEL Model	P8AX09-6G*	P8AX25-6G*
Description	RF coaxial protector - 7 GHz	
Technology	Gas discharge tube	
Frequency range	f DC-7 GHz	DC-7 GHz
Max Power	P 25 W	190 W
Impedance	Z 50 ohms	50 ohms
Insertion loss	< 0.2dB	< 0.2dB
Return loss	> 20 dB	> 20 dB
VSWR	<1.25:1	<1.25:1
Max. Load current	IL 10A	10A
Nominal discharge current <i>8/20µs Test x 10 - C2 Category</i>	In 5 kA	5 kA
Max. discharge current <i>max. withstand @ 8/20 µs by pole</i>	Imax 20 kA	20 kA
Impulse current <i>2 x 10/350µs Test - D1 Category</i>	Iimp 2.5 kA	2.5 kA
Protection level @1 kV/µs - C3 Category	Up < 1100 V	< 1200 V
Typical let through energy (50 ohms) <i>Input 4kV 1.2/50µs - 2kA 8/20µs</i>	2.2 mJ	2.2 mJ
End of life behavior	Short-circuit (fault mode 2 - transmission interruption)	

Mechanical characteristics

Dimensions	see diagram
Connection to Network	N, TNC, SMA, 4.3-10
Disconnection indicator	transmission interrupt
Mounting	Feedthrough
Operating temperature	-40/+85°C
Protection rating	IP66
Housing material	Brass/Surface plating: Cu Zn Sn
Contacts	Bronze/Surface plating: Au or -Ag
Insulation material	PTFE
RohS compliance	yes
Spare unit	2 x BA HF -90/20 2 x BA HF -150/20

Standards

Compliance	IEC 61643-21 / EN 61643-21 / UL497C / UL497E
------------	--

* Part number

TNC connector Female/Female	P8AX09-6G-T/FF	68311	P8AX25-6G-T/FF	68314
TNC connector Male/Female	P8AX09-6G-T/MF	68301	P8AX25-6G-T/MF	68304
N connector Female/Female	P8AX09-6G-N/FF	68011	P8AX25-6G-N/FF	68014
N connector Male/Female	P8AX09-6G-N/MF	68001	P8AX25-6G-N/MF	68004
SMA connector Female/Female	P8AX09-6G-SMA/FF	68511	P8AX25-6G-SMA/FF	68514
SMA connector Male/Female	P8AX09-6G-SMA/MF	68501	P8AX25-6G-SMA/MF	68504
4.3-10 connector Male/Female	P8AX09-6G-4310/MF	-	P8AX25-6G-4310/MF	-
4.3-10 connector Female/Female	P8AX09-6G-4310/FF	-	P8AX25-6G-4310/FF	-

* If no ordering code, please contact us for more information



P8AX09-VG-N/MF

P8AX-VG SERIES



- DC to 7 GHz
- I_{max} : 6 kA
- VSWR ≤ 1.25
- Insertion Loss ≤ 0.2 dB
- Feedthrough mounting
- Bi-Directional
- DC pass
- Waterproof

P8AX -6VG- / /

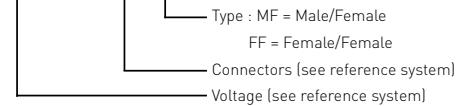

P8AX-VG-N/MF

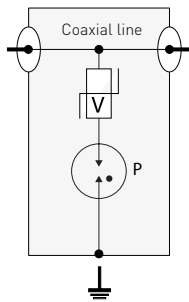
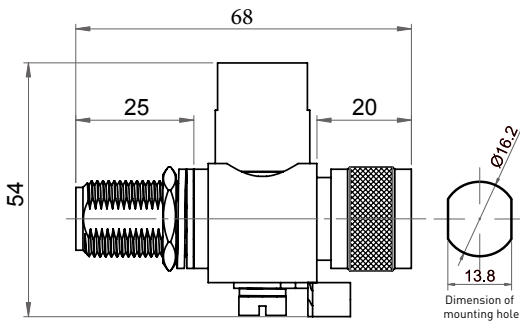

V: Varistor
P: 2-electrode gas tube

Characteristics

CITEL Model	P8AX09-6VG-N/MF	P8AX09-VG-N/MF	P8AX25-VG-F/FF
Description	RF coaxial protector 7 GHz	RF coaxial protector 3.5 GHz	RF coaxial protector 2 GHz
Technology	VG	VG	VG
Frequency range	f DC to 7 GHz	DC to 3.5 GHz	DC to 2 GHz
Max Power	P 70 W	70 W	190 W
Impedance	Z 50 ohms	50 ohms	75 ohms
Insertion loss	< 0.2dB	< 0.2dB	< 0.8dB
Return loss	> 20 dB	> 20 dB	> 13 dB
VSWR	≤ 1.2:1	≤ 1.2:1	≤ 1.5:1
Max. Load current	IL 10A	10A	10A
Nominal discharge current <i>8/20µs Test x 10 - C2 Category</i>	In 3 kA	3 kA	3 kA
Max. discharge current <i>max. withstand @ 8/20 µs by pole</i>	I _{max} 6 kA	6 kA	6 kA
Impulse current <i>2 x 10/350µs Test - D1 Category</i>	I _{imp} 1 kA	1 kA	1 kA
Protection level <i>@ 1kV/µs - C3 Category</i>	U _p < 1200 V	< 800 V	< 900 V
End of life behavior	Short-circuit (fault mode 2 - transmission interruption)		
Mechanical characteristics			
Dimensions	see diagram		
Connection to Network	connector N Male/ Female	connector N Male/ Female	connector F Female/ Female
Disconnection indicator	transmission interrupt		
Mounting	Feedthrough		
Operating temperature	-40/+85°C		
Protection rating	IP66		
Housing material	Brass/Surface plating : Cu Zn Sn		
Contacts	Bronze/Surface plating: Au or -Ag		Bronze/Surface plating: Au
Insulation material	PTFE		
RohS compliance	yes		
Spare unit	-	-	-
Standards			
Compliance	IEC 61643-21 / EN 61643-21 / UL497C / UL497E		
Part number			
	69001	60601	60701

«QUARTER-WAVE» COAXIAL PROTECTORS

PRC SERIES



PRC1800-716/MF

- Low insertion losses
- I_{max} > 50 kA
- Available for wide-band application
- No maintenance

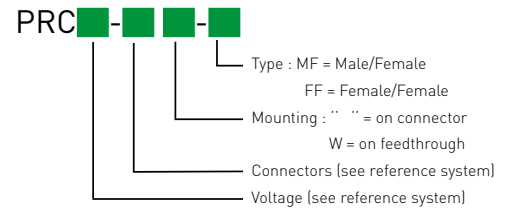

Characteristics

CITEL Model	PRC822S*	PRC900*	PRC1800*	PRC2100*	PRC5800*
Description	"Quarter wave" coaxial protector				
Technology	Quarter Wave	Quarter Wave	Quarter Wave	Quarter Wave	Quarter Wave
Frequency range	f 800-2200MHz	870-960MHz	1700-1950MHz	1800-2400MHz	4500-6000MHz
Max Power	P 1500 W (7/16 = 2500 W)	1500 W (7/16 = 2500 W)	1500 W (7/16 = 2500 W)	1500 W	1500 W
Impedance	Z 50 ohms	50 ohms	50 ohms	50 ohms	50 ohms
Insertion loss	< 0.2 dB	< 0.2 dB	< 0.2 dB	< 0.2 dB	< 0.2 dB
Return loss	> 20 dB	> 20 dB	> 20 dB	> 20 dB	> 20 dB
VSWR	<1.2:1	<1.2:1	<1.2:1	<1.2:1	<1.2:1
PIM 3rd order (2x20W)	<-160 dBc	<-160 dBc	<-160 dBc	<-160 dBc	<-160 dBc
Max. Load current	IL 10A	10A	10A	10A	10A
Nominal discharge current <i>8/20µs Test x 10 - C2 Category</i>	In 25 kA	50 kA	50 kA	25 kA	25 kA
Max. discharge current <i>max. withstand @ 8/20 µs by pole</i>	I _{max} 50 kA	100 kA	100 kA	50 kA	50 kA
Impulse current <i>2 x 10/350µs Test - D1 Category</i>	I _{imp} 25 kA	50 kA	50 kA	25 kA	25 kA
Protection level @ 1kV/µs- C3 Category	Up < 30 V	< 30 V	< 30 V	< 30 V	< 30 V
Failsafe behavior	without	without	without	without	without
Mechanical characteristics					
Dimensions	see diagram				
Connection to Network	N, 4.3-1 or 7/16 connector	N, 4.3-10, TNC or 7/16 connector	N, 4.3-10, TNC or 7/16 connector	N connector	N connector
Mounting	on connector or feedthrough (W version)				connector
Operating temperature	-40/+85°C				
Protection rating	IP66				
Housing material	Brass/Surface plating : Cu Zn Sn				
Contacts	Bronze/Surface plating: Au or -Ag				
Insulation material	PTFE				
Standards					
Compliance	IEC 61643-21 / EN 61643-21 / UL497C / UL497E				
* Part number					
N connector Female/Female	PRC822S-N/FF 61013	PRC900-N/FF 621124	PRC1800-N/FF 621125	PRC2100-N/FF -	PRC5800-N/FF 621151
N connector Male/Female	PRC822S-N/MF 61003	PRC900-N/MF 621111	PRC1800-N/MF 621112	PRC2100-N/MF 621183	PRC5800-N/MF 621112
N connector Female/Female - Feedthrough mounting	-	-	-	PRC2100-NW/ FF 621172	-
N connector Male/Female - Feedthrough mounting	-	-	PRC1800-NW/ MF 61108	PRC2100-NW/ MF	-
T connector Female/Female	-	PRC900-T/FF 621126	PRC1800-T/FF 621127	-	-
T connector Male/Female	-	PRC900-T/MF 621113	PRC1800-T/MF 621115	-	-
7/16 connector Male/Female	PRC822S-716/MF 621139	PRC900-716/MF 621110	PRC1800-716/MF 621108	-	-
7/16 connector Female/Female	PRC822S-716/FF 67413	PRC900-716/FF 621109	PRC1800-716/FF 621107	-	-
4.3-10 connector Male/Female	PRC822S-4310/MF -	PRC900-4310/MF -	PRC1800-4310/MF -	-	-
4.3-10 connector Female/Female	PRC822S-4310/FF -	PRC900-4310/FF -	PRC1800-4310/FF -	-	-

* If no ordering code, please contact us for more information

«QUARTER-WAVE» COAXIAL PROTECTORS

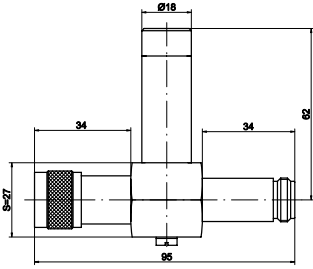

PRC822S-N/MF

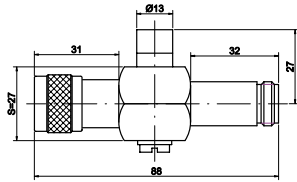

PRC5800-N/MF

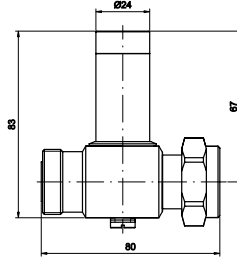

PRC822S-716/MF

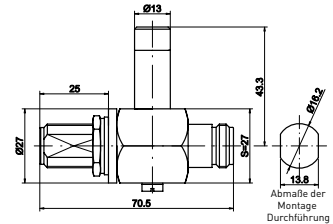

PRC2100-NW/FF

Abmaße der Montage Durchführung

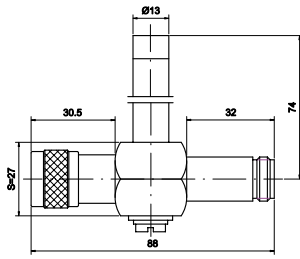

PRC900-N/MF

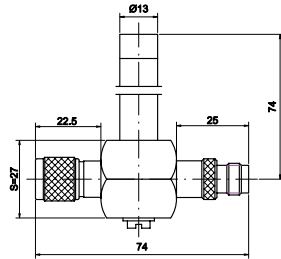

PRC900-T/MF

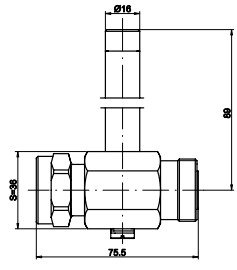

PRC900-716/MF

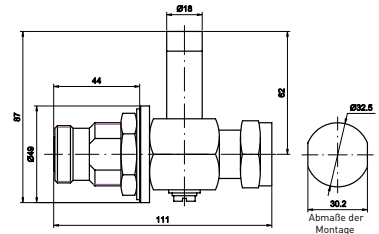

PRC822S-716W/MF

Abmaße der Montage Durchführung

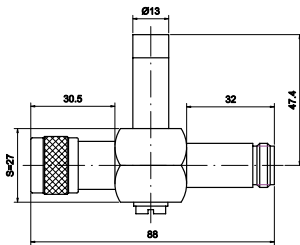

PRC1800-N/MF

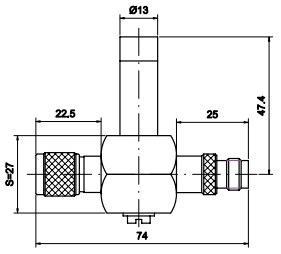

PRC1800-T/MF

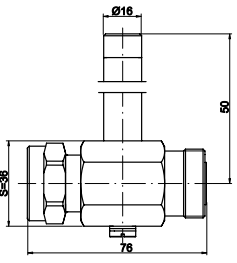

PRC1800-716/MF

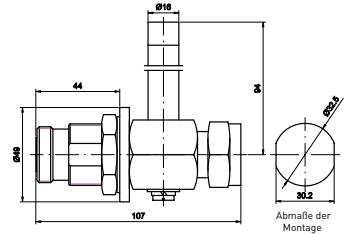

PRC900-716W/MF

Abmaße der Montage Durchführung

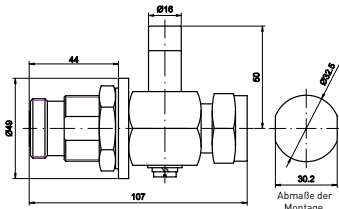

PRC1800-716W/MF

Abmaße der Montage Durchführung

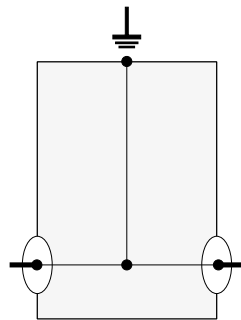

CNP AND CXP SERIES



- RoHS 6 compliance
- Waterproof
- Mounting on plate
- Bi-directional

Characteristics

CITEL Model	CNP90TV-F/*	CNP230TV-F/FF	CXP09*	CXP25*	CXP09*-DCB	CXP25*-DCB
Description	Coaxial SPD for video transmission networks	Coaxial SPD for video transmission networks	Coaxial SPD low frequency	Coaxial SPD low frequency	Coaxial SPD low frequency	Coaxial SPD low frequency
Technology	Gas discharge tube	Gas discharge tube	Gas discharge tube	Gas discharge tube	GDT+Filter	GDT+Filter
Frequency range	f DC-1 GHz	DC-1 GHz	DC-1 GHz	DC-1 GHz	125-1000 MHz	125-1000 MHz
Max Power	P 25 W	190 W	25 W	190 W	25 W	190 W
Impedance	Z 50/75 ohms	50/75 ohms	50/75 ohms	50/75 ohms	50/75 ohms	50/75 ohms
Insertion loss	< 0.6 dB	< 0.6 dB	< 0.5 dB	< 0.5 dB	< 1 dB	< 1 dB
Return loss	> 20 dB	> 20 dB	> 18 dB	> 18 dB	> 20 dB	> 20 dB
VSWR	< 1.35:1	< 1.35:1	< 1.3:1	< 1.3:1	<1.3:1	<1.3:1
Max. Load current	IL 0.5 A	0.5 A	0.5 A	0.5 A	0.5 A	0.5 A
Nominal discharge current <i>8/20µs Test x 10 - C2 Category</i>	In 5 kA	5 kA	5 kA	5 kA	5 kA	5 kA
Max. discharge current <i>-max. withstand @ 8/20 µs by pole</i>	Imax 20 kA	20 kA	20 kA	20 kA	20 kA	20 kA
Impulse current <i>2 x 10/350µs Test - D1 Category</i>	limp 2.5 kA	2.5 kA	2.5 kA	2.5 kA	2.5 kA	2.5 kA
Protection level <i>@ 1kV/µs- C3 Category</i>	Up 600 V	600 V	600 V	600 V	600 V	600 V
End of life behavior	Short-circuit (fault mode 2 - transmission interruption)					
Mechanical characteristics						
Dimensions	see diagram					
Connection to Network	Connector F female/female		N or F connector		N or F connector	
Disconnection indicator	transmission interrupt					
Mounting	on plate					
Operating temperature	-40/+85°C					
Protection rating	IP20					
Housing material	Metal+plastic		Brass			
Standards						
Compliance	IEC 61643-21 / EN 61643-21 / UL497C / UL497E					
*Part number						
N connector Female/Female	-	-	CXP09-N/FF 631655	CXP25-N/FF -	CXP09-N/FF-DCB 631652	CXP25-N/FF-DCB 631752
N connector Male/Female	-	-	CXP09-N/MF -	CXP25-N/MF 631754	CXP09-N/MF-DCB 631653	CXP25-N/MF-DCB 631753
F connector Female/Female	CNP90TV-F/FF 6329012	CNP230TV-F/FF 632302	CXP09-F/FF 631651	CXP25-F/FF 631757	-	-
F connector Male/Female	CNP90TV-F/MF 6329011	-	CXP09-F/MF 631611	CXP25-F/MF -	-	-

* If no ordering code, please contact us for more information

COAXIAL SURGE PROTECTOR LOW FREQUENCY

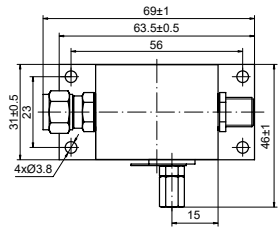

CXP-F/MF

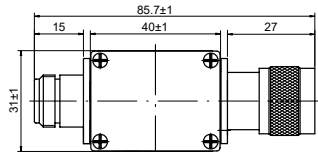

CXP-N/MF

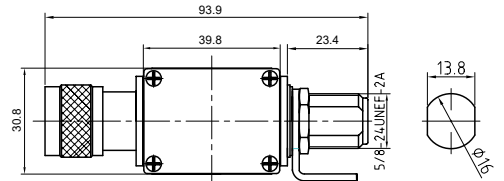

CXP-N/MF/DCB

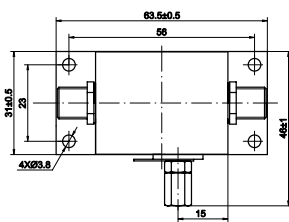

CXP-F/FF

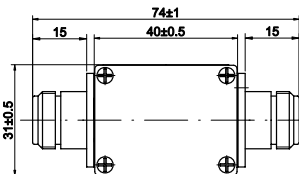

CXP-N/FF

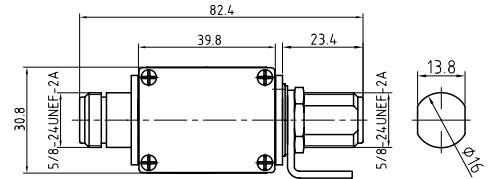

CXP-N/FF/DCB

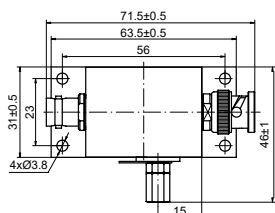

CXP-B/MF

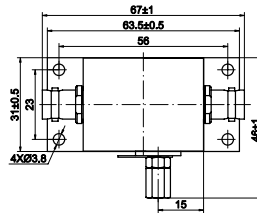

CXP-B/FF

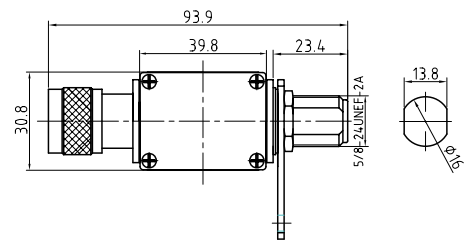

CXP-NW/MF/DCB

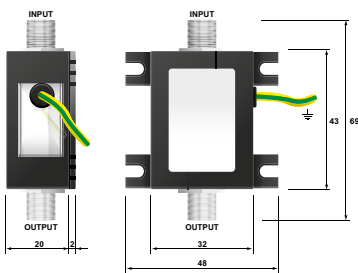

CNP

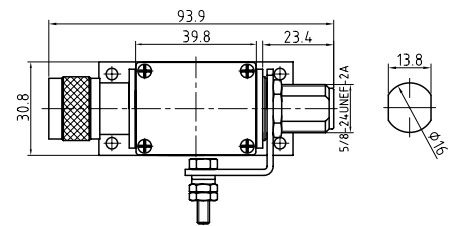

CXP-NW/MF/DCB Bulkhead

CNP
CXP

CXP-DCB

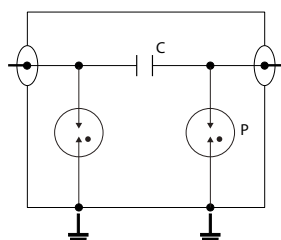
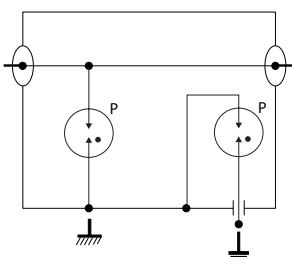

P : Gas discharge tube
C : Capacitance

BRACKET FOR COAXIAL SURGE PROTECTOR

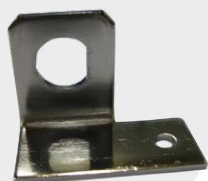

BK-T
bracket for TNC connector



BK-N
bracket for N connector



BK-SMA
bracket for SMA connector

- Screw fixing
- Grounding
- Requires a feedthrough connector

Mounting bracket

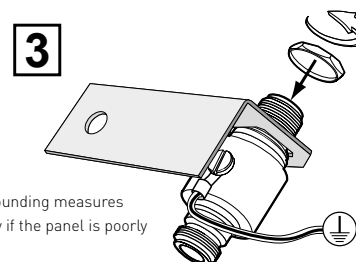
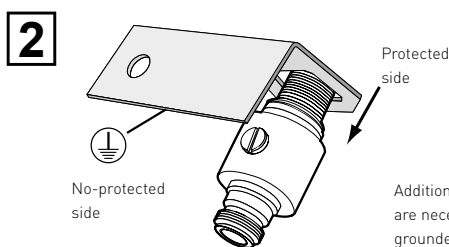
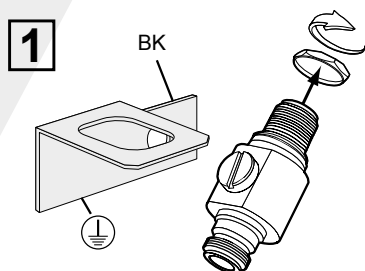

Reference bracket

CITEL	Part number	Connection
BK-D	66001	7/16
BK-F*	66002	F
BK-N*	66003	N
BK-SMA	66006	SMA
BK-T/BK-B	66007	BNC and TNC
BK-U	66011	UHF
BK-43	-	4.3-10

* Mounting brackets are available with various dimensions [Screw hole distance]. Contact us for further information.

GAS DISCHARGE TUBE

- GDT for maintenance of coaxial surge protectors P8AX
- Adapted for use in very high frequency
- Selection according to the RF signal power

Reference	Part number*	for P8AX
BBHF 90/20	927000107	P8AX09-xxx
BBHF 150/20	927000207	P8AX15-xxx
BBHF 250/20	927005907	P8AX25-xxx
BBHF 350/15	927006507	P8AX35-xxx
BBHF 500/20	927002207	P8AX50-xxx
BAHF 90/20	927100107	P8AX09-6G
BAHF 150/20	927100207	P8AX 25-6G

* P/N code is for 10 GDTs packaging



BB HF



CITEL

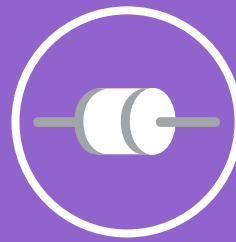
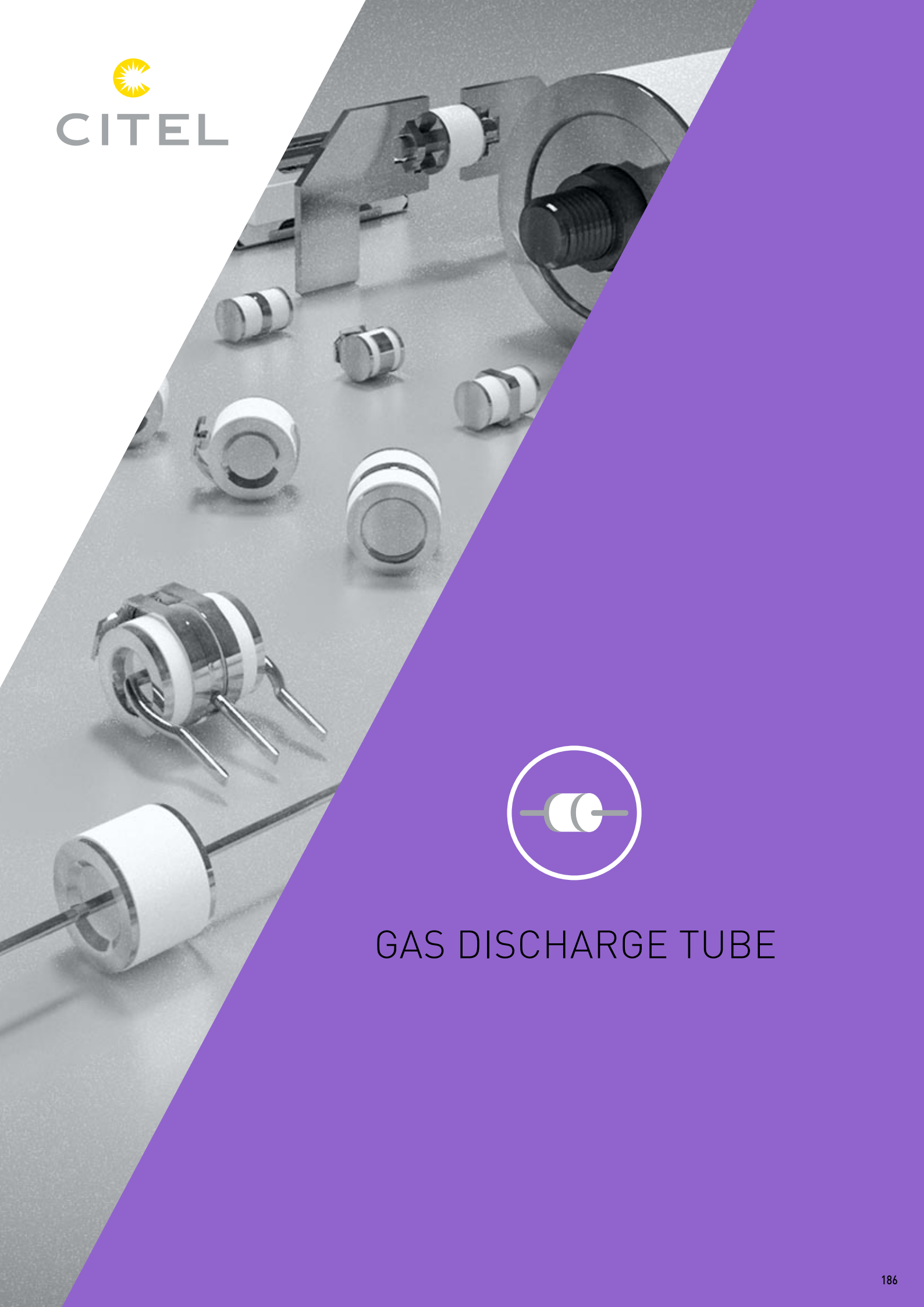

GAS DISCHARGE TUBE

GAS DISCHARGE TUBES

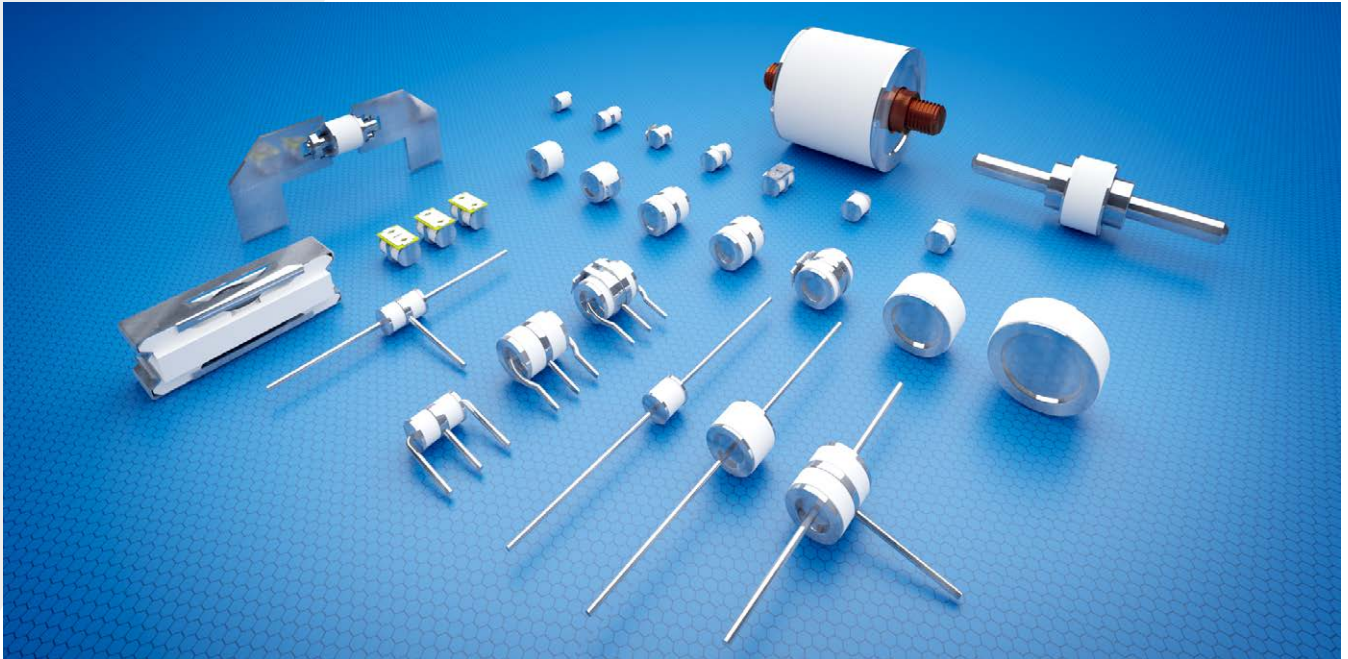

The Gas Discharge Tubes (or GDT) are passive components made of two or three electrodes in an enclosure filled with a (non-radioactive) rare gas at a controlled pressure.

The enclosure is a ceramic tube with its ends closed off by metal caps that also serve as electrodes.

Their main use is to protect telecommunications lines, but other uses are possible.

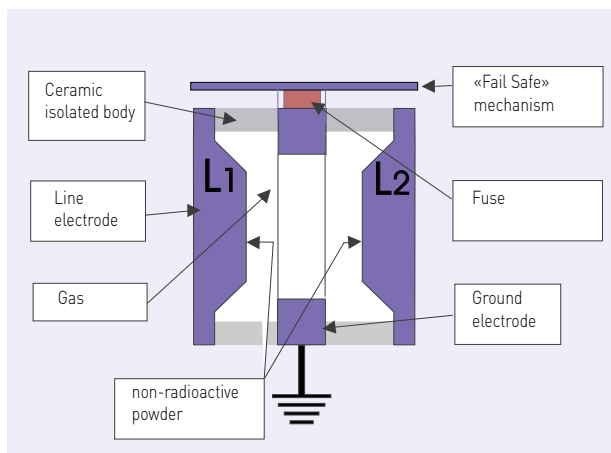

OPERATION

The gas discharge tube may be regarded as a sort of very fast switch having conductance properties that change very rapidly, when breakdown occurs, from open-circuit to quasi-short circuit (arc voltage about 20V). There are accordingly four operating domains in the behavior of a gas discharge tube:

- **Non-operating domain**, characterized by practically infinite insulation resistance;
- **Glow domain** : At breakdown, the conductance increases suddenly; if the current drained off by the gas tube is less than about 0.5A (this is a rough value that differs according to the type of component), the glow voltage across the terminals will be in the 80-100V range;
- **Arc regime** : as the current increases, the gas discharge tube shifts from the glow voltage to the arc voltage (20V). It is in this domain that the gas discharge tube is most effective, because the current discharged can reach several thousand amperes without the arc voltage across its terminals increasing.
- **Extinction** : At a bias voltage roughly equal to the glow voltage, the gas tube recovers its initial insulating properties.

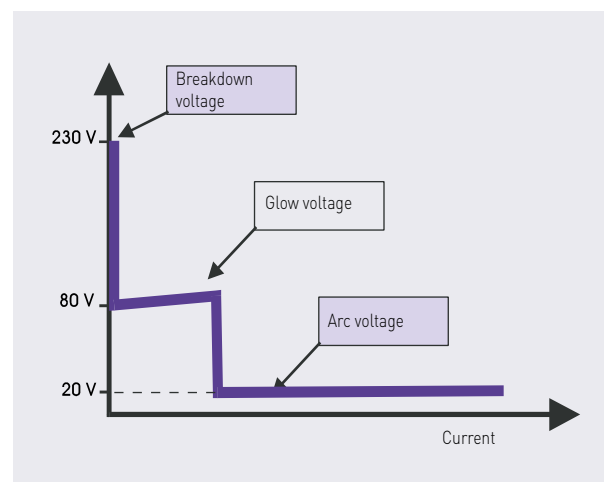

Operating regimes

ELECTRICAL CHARACTERISTICS

The main electrical characteristics defining a gas discharge tube are :

- DC sparkover voltage (Volts)
- Impulse sparkover voltage (Volts)
- Discharge current capacity (kA)
- Insulation resistance (Gohms)
- Capacitance (pF).

DC sparkover voltage

This is the main characteristic defining the gas discharge tube. It is the voltage at which breakdown will occur between the electrodes when a slowly increasing voltage ($dV/dt = 100 \text{ V/s}$) is applied to the component; it depends on the electrode spacing, the pressure, and the properties of the gas mixture and of the emissive substance.

Range of DC sparkover voltages available:

- minimum 75V
- average 230V
- high voltage 500V
- very high voltage 1000 to 3000V

The tolerance on the breakdown voltage is generally $\pm 20\%$.

DC and Impulse sparkover voltages

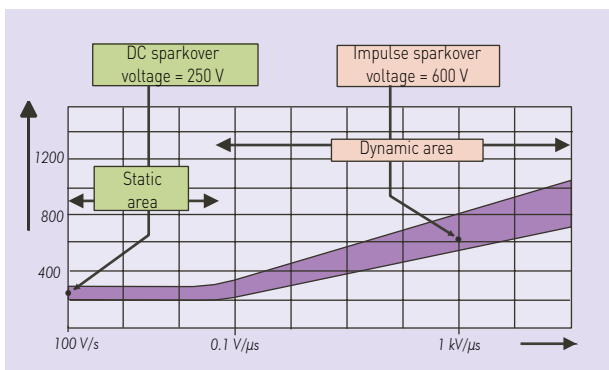

Discharge current

This depends on the properties of the gas, the volume, and the material and treatment of the electrodes. It is the major characteristic of the GDT and the one that distinguishes it from other protection devices (Varistor, Zener diode, etc.): 5 to 20kA with an 8/20μs impulse for the standard components. This is the value the device can withstand repeatedly (say for ten impulses) without destruction or alteration of its basic specifications.

Impulse sparkover voltage

Sparkover voltage in the presence of a steep rise front ($dV/dt = 1 \text{ kV}/\mu\text{s}$): the impulse sparkover voltage increases with increasing dV/dt .

Insulation resistance and capacitance

These characteristics make the gas discharge tube practically «invisible» in a line in a steady-state context: insulation resistance very high ($>10 \text{ Gohm}$), capacitance very low ($<1 \text{ pF}$).

3-ELECTRODE CONFIGURATION

Protecting a two-wire line (for example a telephone pair) with two 2-electrode gas discharge tubes (connected between the wires and ground) may cause the following problem:

The line is subjected to an overvoltage in common mode; because of the dispersion of the sparkover voltages ($\pm 20\%$), one of the gas discharge tubes sparks over a very short time before the other (a few microseconds); the wire that has sparked over is therefore grounded (neglecting the arc voltages), turning the common-mode overvoltage into a differential-mode overvoltage, very dangerous for the terminal equipment. This risk disappears when the second gas discharge tube arcs over (a few microseconds later). 3-electrode gas tube geometry eliminates this drawback: the sparkover of one pole causes a «general» breakdown of the device almost instantaneously (a few nanoseconds) because there is only one gas-filled enclosure.

END OF LIFE

Gas discharge tubes are designed to withstand several impulses without destruction or loss of the initial characteristics (typical impulse tests: 10 times 5 kA impulses of each polarity).

On the other hand, a sustained strong current (e.g. 10 A rms for 15 seconds, simulating the fall of a AC power line onto a telecommunication line) will put the device out of service definitively.

If a fail-safe end of life is desired (i.e. a short-circuit that will report the fault to the user when the line fault is detected), gas discharge tubes with the fail-safe feature (external short-circuit) should be chosen.

STANDARDS

CITEL gas discharge tubes comply with the specifications of main telecom operators and with the ITU-T K12 international recommendation and standards IEC 61643-311.

CITEL gas discharge tubes are also compliant with the RoHS Directive

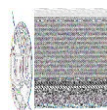

GAS DISCHARGE TUBES

MECHANICAL CHARACTERISTICS

CITEL gas discharge tubes are available in several mechanical configurations to adapt to mounting on:

- Bare version for mounting adapted support
- "S" version wire output (diameter 0.8 or 1 mm) for mounting on printed circuit
- "SMD" version for surface mounting, with optional "SQ" version (anti-roll square electrode).
- Specific versions: output by cable or rod

Surface mounting

Most of CITEL range of gas discharge tubes are available for surface mounting (SMD), with optional "anti-rolling" version with square electrode (SQ). The welding profile with reflow must follow the recommended curve (opposite).

The 3-poles BMSQ CMS FL gas tube is particularly adapted to surface-mount technology, with its "anti-rolling" electrode and its exclusive external short-circuit system adapted to this type of mounting.



Printed circuit mounting

The majority of CITEL gas discharge tube ranges are available with wire output (diameter 0.8 or 1 mm) for mounting on a printed circuit board. Different types of output possible according to the range: axial, radial, straight output, folded output..... Wave solder mounting must be done following the recommended profile (opposite)

Radial Taping

The CITEL gas discharge tubes with wire output are provided in a radial tape in a pack of 500 components according to the ranges (plan opposite) and in line with the IEC 286-1 specification.

Tape and Reel

The CITEL SMD gas discharge tubes with SMT mounting are provided in a Tape and Reel pack, reel of 500, 800 or 1000 components (plan opposite) and in line with the IEC 286-1 specification

THE CITEL LINE

CITEL proposes a full line of gas discharge tubes to meet most configuration needs and specifications found on the market :

- 2- and 3-electrode gas discharge tubes
- Sparkover voltages from 75 to 3000 V
- Discharge capacities from 5 to 150 kA (8/20 μ s)
- Optional external short-circuit device
- Installation on support, on printed circuit, or surface-mounted devices.

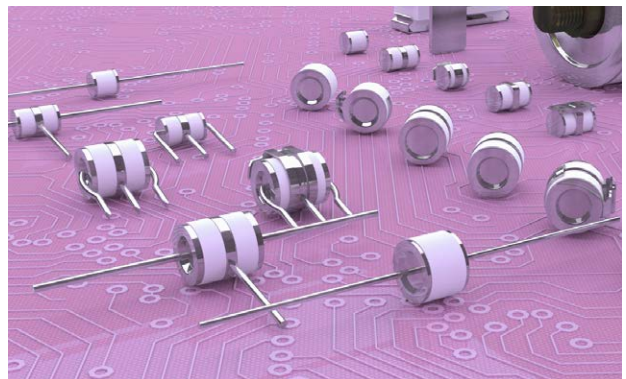

GSG SERIES

Thanks to our inherent knowledge and experience in the field of gas discharge tubes, CITEL has developed a specific technology: **GSG (Gas-filled Spark Gap)**.

These components are designed to be used on an AC network: they have an increased extinction capability and a higher current discharge capability with either a 8/20 μ s or 10/350 μ s waveform. The GSG components are the heart of the VG technology which insures equal performances to all air gap technologies without any of their downsides..

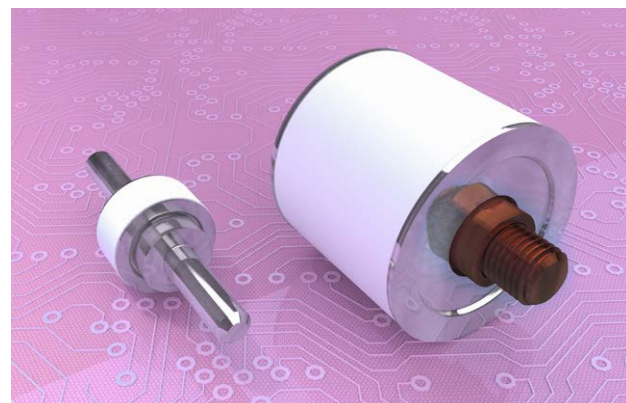

Welding curve by reflow for SMT gas discharge tubes

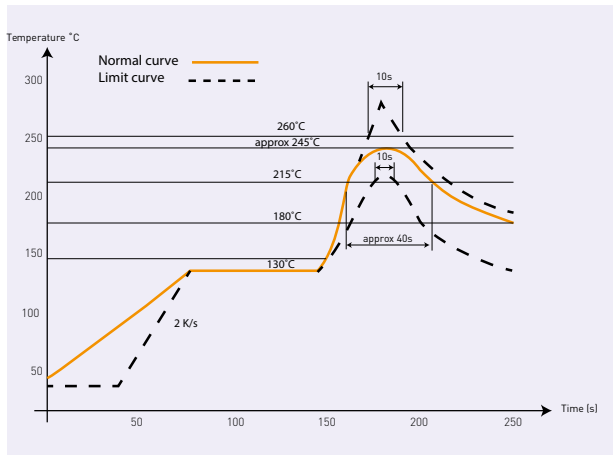

Wave soldering cycle for gas discharge tubes

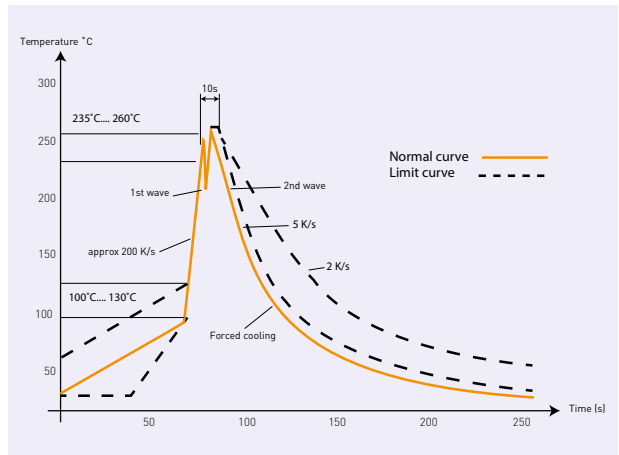

Radial Taping layout for gas discharge tubes with wire output (IEC 286-1)

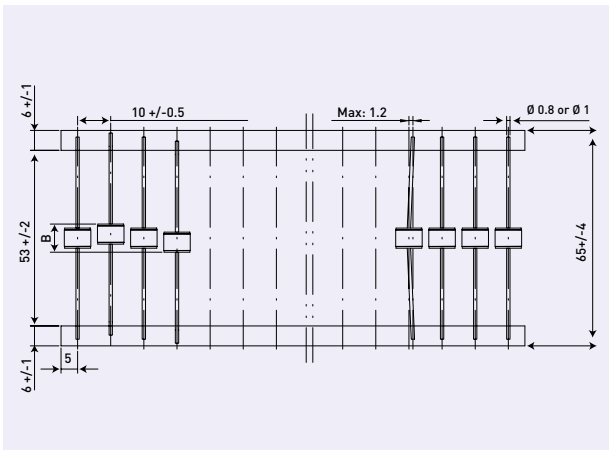



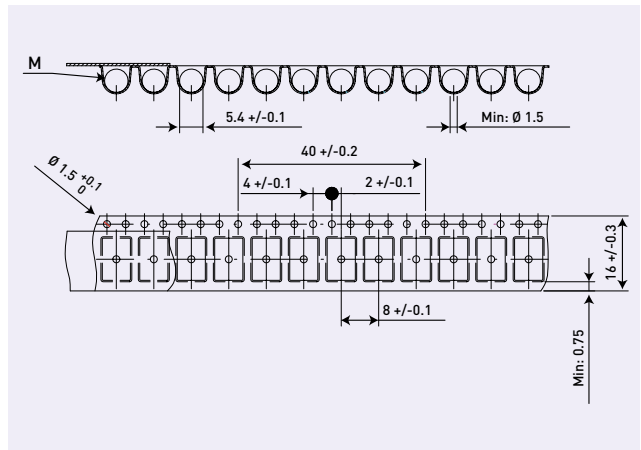





Tape & Reel for gas discharge tubes with SMD mounting (IEC 286-3)



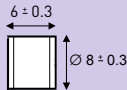
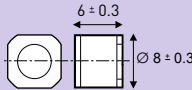
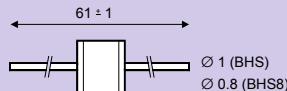
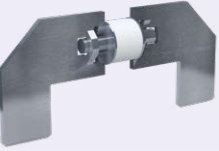

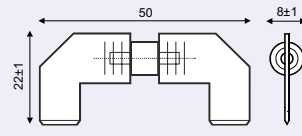

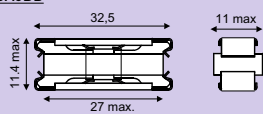







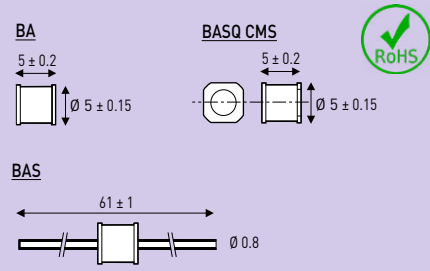

SELECTION GUIDE

2-ELECTRODE

Range	CITEL model	DC sparkover voltage (100V/s)	Impulse sparkover voltage (1kV/ μ s)	Insulation resistance (100Vdc)	Capacitance	Holdover voltage (R = 300 ohms in serie R = 150 ohms; 100nF in parrallel)	AC discharge current (50Hz)	Max. discharge current (8/20 μ s ; 1 fois)	Nominal discharge current (8/20 μ s ; 10 fois)	Mechanical
BH  BH  BH > 1000V  BHSQ  BHS	BH 90	72-108 V	<580 V	>10G Ω	<0.8 pF	>80 V	20 A	40 kA	20 kA	 BH BHSQ CMS   BHS  Options : - Lead termination(\emptyset 1 ou 0.8 mm) : BHS or BHS8 - BHS Tape & Reel : 500 p. - External short-circuit: BHC - Square electrode/ SMD : BHSQ CMS - BHSQ CMS Tape & Reel : 500 p.
	BH 230	184-276 V	<700 V	>10G Ω	<0.8 pF	>80 V	20 A	40 kA	20 kA	
	BH 350	280-420 V	<850 V	>10G Ω	<0.8 pF	>80 V	20 A	40 kA	20 kA	
	BH 470	376-564 V	<1000 V	>10G Ω	<0.8 pF	>80 V	20 A	40 kA	20 kA	
	BH 500	400-600 V	<1200 V	>10G Ω	<0.8 pF	>80 V	20 A	40 kA	20 kA	
	BH 600	480-720 V	<1200 V	>10G Ω	<0.8 pF	>80 V	20 A	40 kA	20 kA	
	BH 800	640-690 V	<1400 V	>10G Ω	<0.8 pF	>80 V	10 A	25 kA	10 kA	
	BH 1400	1120-1680 V	<2100 V	>10G Ω	<0.8 pF	>120 V	10 A	25 kA	10 kA	
	BH 1500	1200-1800 V	<2300 V	>10G Ω	<0.8 pF	>120 V	10 A	25 kA	10 kA	
	BH 2500	2000-3000 V	<3800 V	>10G Ω	<0.8 pF	>120 V	10 A	25 kA	10 kA	
BH 3000	2400-3600 V	<4600 V	>10G Ω	<0.8 pF	>120 V	10 A	25 kA	10 kA		
CA8BC 	CA8BC-230	184-276 V	<1000 V	>1G Ω	<10 pF	>72 V	20 A	25 kA	10 kA	 CA8BC 
	CA8BC-250	220-280 V	<1000 V	>1G Ω	<10 pF	>72 V	20 A	25 kA	10 kA	
	CA8BC-350	280-420 V	<1000 V	>1G Ω	<10 pF	>72 V	20 A	25 kA	10 kA	
CA8BB 	CA8BB-250	220-280 V	<750 V	>1G Ω	<10 pF	>72 V	20 A	25 kA	10 kA	 CA8BB 
	CA8BB-300	240-360 V	<800 V	>1G Ω	<10 pF	>72 V	20 A	25 kA	10 kA	





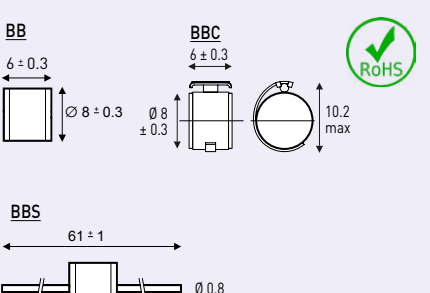





SELECTION GUIDE

2-ELECTRODE

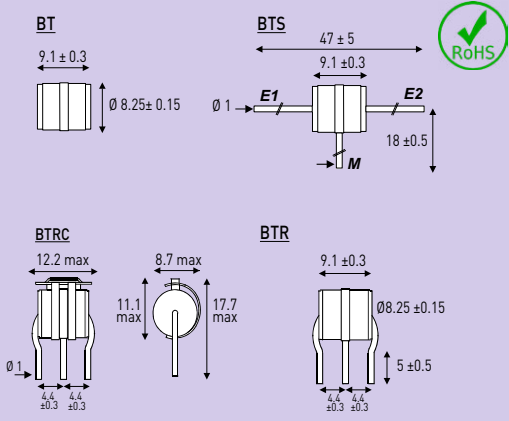
Range	CITEL model	DC sparkover voltage (100V/s)	Impulse sparkover voltage (1kV/μs)	Insulation resistance (100Vdc)	Capacitance	Holdover voltage (R = 300 ohms in serie R = 150 ohms; 100nF in parallel)	AC discharge current (50Hz)	Max. discharge current (8/20μs ; 1 fois)	Nominal discharge current (8/20μs ; 10 fois)	Mechanical
BA      	BA 90	72-108 V	<600 V	>10GΩ	<0.3 pF	>60 V	10 A	25 kA	10 kA	 <p>Options</p> <ul style="list-style-type: none"> - Lead termination: BAS - External short-circuit: BAC - SMD version: BASQ CMS [Square electrode] and BA CMS - BAS Tape & Reel : 800 p. - BASQ CMS and BA CAM : 1000p
	BA 150	120-180V	<700 V	>10GΩ	<0.3 pF	>80 V	10 A	25 kA	10 kA	
	BA 230	184-276 V	<700 V	>10GΩ	<0.3 pF	>80 V	10 A	25 kA	10 kA	
	BA 300	240-360 V	<900 V	>10GΩ	<0.3 pF	>80 V	10 A	25 kA	10 kA	
	BA 350	280-420 V	<900 V	>10GΩ	<0.3 pF	>80 V	10 A	25 kA	10 kA	
	BA 550	440-660 V	<1200 V	>10GΩ	<0.3 pF	>80 V	10 A	25 kA	10 kA	
BB       	BB 75	65-95 V	<620 V	>10GΩ	<0.8 pF	>60 V	10 A	25 kA	10 kA	 <p>Options</p> <ul style="list-style-type: none"> - Lead termination: BBS - External short-circuit: BBC - BBS Tape & Reel : 500p.
	BB 90	72-108 V	<580 V	>10GΩ	<0.8 pF	>60 V	10 A	25 kA	10 kA	
	BB 150	120-180 V	<640 V	>10GΩ	<0.8 pF	>75 V	10 A	25 kA	10 kA	
	BB 230	184-276 V	<700 V	>10GΩ	<0.8 pF	>80 V	10 A	25 kA	10 kA	
	BB 350	280-420 V	<850 V	>10GΩ	<0.8 pF	>80 V	10 A	25 kA	10 kA	
	BB 500	400-600 V	<1200 V	>10GΩ	<0.8 pF	>80 V	10 A	25 kA	10 kA	
BB 600	510-690 V	<1200 V	>10GΩ	<0.8 pF	>80 V	10 A	25 kA	10 kA		

SELECTION GUIDE

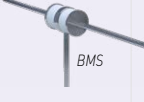
3-ELECTRODE

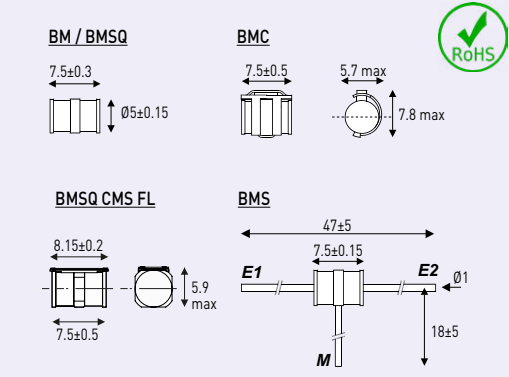





Range	CITEL model	DC sparkover voltage (100V/s)	Impulse sparkover voltage (1kV/ μ s)	Insulation resistance (100Vdc)	Capacitance	Holdover voltage (R = 300 ohms in serie R = 150 ohms; 100nF in parallel)	AC discharge current (50Hz)	Max. discharge current (8/20 μ s ; 1 fois)	Nominal discharge current (8/20 μ s ; 10 fois)	Mechanical
BT  BT  BTC  BTR  BTS	BT 90	72-108 V	<620 V	>10G Ω	<0.9 pF	>70 V	20 A	25 kA	20 kA	 <p>BT</p> <p>BTS</p> <p>BTRC</p> <p>BTR</p> <p>Options</p> <ul style="list-style-type: none"> - Axial wire output: BTS - Radial wire output: BTR - External short-circuit: BTC, BTRC,
	BT 150	120-180 V	<600 V	>10G Ω	<0.9 pF	>80 V	20 A	25 kA	20 kA	
	BT 230	184-276 V	<680 V	>10G Ω	<0.9 pF	>80 V	20 A	25 kA	20 kA	
	BT 350	280-420 V	<800 V	>10G Ω	<0.9 pF	>80 V	20 A	25 kA	20 kA	
	BT 500	400-600 V	<1100 V	>10G Ω	<0.9 pF	>80 V	20 A	25 kA	20 kA	
BM  BM  BMSQ CMS FL  BMSQ  BMS  BMS5	BM 90	72-108 V	<560 V	>10G Ω	<0.5 pF	>60 V	10 A	25 kA	10 kA	 <p>BM / BMSQ</p> <p>BMC</p> <p>BMSQ CMS FL</p> <p>BMS</p> <p>Options</p> <ul style="list-style-type: none"> - Lead termination: BMS, BMS5 - External short-circuit: BMC, BM..FL - SMD : BMSQ CMS (Square electrode) and BM CMS - Tape & Reel CMS : 1000 p.
	BM 150	120-180 V	<600 V	>10G Ω	<0.5 pF	>80 V	10 A	25 kA	10 kA	
	BM 230	184-276 V	<680 V	>10G Ω	<0.5 pF	>80 V	10 A	25 kA	10 kA	
	BM 350	280-420 V	<900 V	>10G Ω	<0.5 pF	>80 V	10 A	25 kA	10 kA	
	BM 500	400-600 V	<1100 V	>10G Ω	<0.5 pF	>80 V	10 A	25 kA	10 kA	

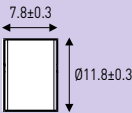

CITEL

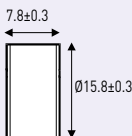
SELECTION GUIDE

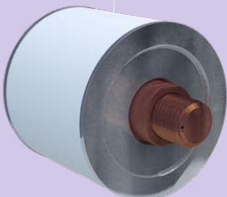
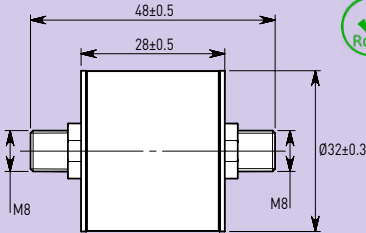
GSG

Range	CITEL part number	DC sparkover voltage (100V/s)	Impulse sparkover voltage (1.2/50µs / 6kV)	Insulation resistance (100Vdc)	Follow current interrupting capability (Ifi) (VAC 50 Hz)	Nominal discharge current (In) 8/20µs, following IEC 61643-11)	Max. discharge current (Imax) (8/20µs ; following IEC 61643-11°)	Max. impulse current (Iimp) (10/350µs ; following IEC 61643-11)	Mechanical
BH	BH 800 NPE	> 650 V	<1500 V	> 1 GΩ	> 100 A	5 kA	10 kA	-	
BG 	BG 600	> 450 V	<1500 V	>1 GΩ	> 100 A	60 kA	100 kA	15 kA	 
	BG 800	> 650 V	<1500 V	>1 GΩ	> 100 A	60 kA	100 kA	15 kA	
	BG 1000	> 850 V	<1800 V	>1 GΩ	> 100 A	60 kA	100 kA	15 kA	
	BG 1300	> 1100 V	<2000 V	>1 GΩ	> 100 A	60 kA	100 kA	15 kA	
BF 	BF 800	> 650 V	<1500 V	>1 GΩ	> 100 a	80 kA	150 kA	50 kA	 
	BF 1300	> 1100 V	<2500 V	>1 GΩ	> 100 A	80 kA	150 kA	50 kA	
BE 	BE 800	> 650 V	<1500 V	>1 GΩ	> 100 A	100 kA	200 kA	100 kA	 

ISG

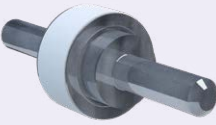
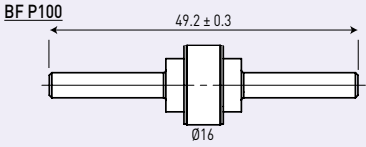
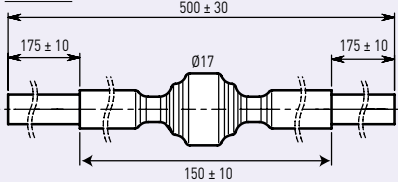
Range	CITEL part number	DC sparkover voltage (100V/s)	Impulse sparkover voltage (1.2/50µs / 6kV)	Insulation resistance (100Vdc)	Nominal discharge current (In) 8/20µs, suivant IEC 61643-11)	Max. discharge current (Imax) (8/20µs ; suivant IEC 61643-11)	Max. impulse current (Iimp) (10/350µs ; suivant IEC 61643-11)	Mechanical
BF P100 	BFP100-230	184-276 V	<900 V	>10 GΩ	80 kA	150 kA	50 kA	 
	BFP100-250	200-300 V	<900 V	>10 GΩ	80 kA	150 kA	50 kA	
	BFP100-350	280-420 V	<1000 V	>10 GΩ	80 kA	150 kA	50 kA	
	BFP100-500	400-600 V	<1200 V	>10 GΩ	80 kA	150 kA	50 kA	
	BFP100-600	480-720 V	<1300 V	>10 GΩ	80 kA	150 kA	50 kA	
	BFP100-750	600-900 V	<1500 V	>10 GΩ	80 kA	150 kA	50 kA	



CITEL

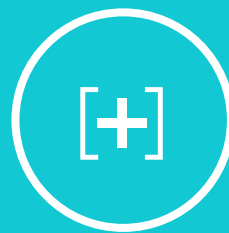

MISCELLANEOUS OBSTRUCTIONS LIGHTS

AUTOMATIC AC VOLTAGE MONITORING RELAY



VMXXX-DIN



- Protection against over / under voltage of AC network
- Automatic operation
- re-engagement delayed
- Operating indicators
- Easy installation on DIN rail
- Compliance with EN 50550

VM~~xxx~~-DIN
 └──────────────────┘ Operating voltage

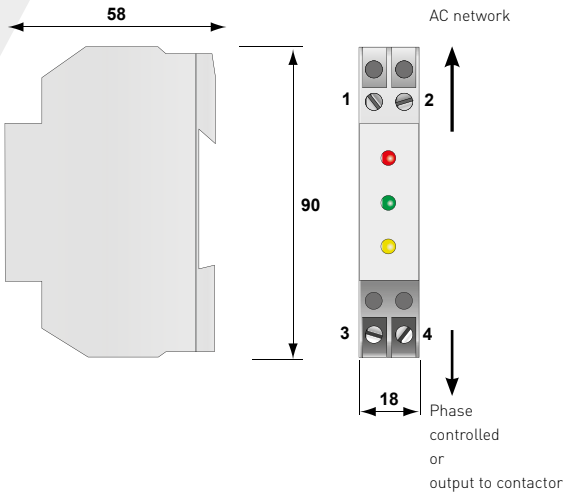

Characteristics

CITEL model	VM230-DIN	VM120-DIN
AC network	230 V single phase	120 V single phase
Voltage range OK	195 V up to 270 Vac	95 V up to 140 Vac
Disconnection undervoltage	< 195 Vac	< 95 Vac
Disconnection overvoltage	> 270 Vac	> 140 Vac
Disconnection delay	1 second (typical)	
Reset delay	1 second (typical)	
Output controlled	1 T / 5 A @ 250 V	
Status indication by leds	yellow : undervoltage (disconnection) green : correct voltage red : overvoltage (disconnection)	
Format	DIN box 1 module of 18 mm	
Standards		
Compliance	EN 50550	
Part number	3569013	3569012

Installation

Nominal line current < 5A

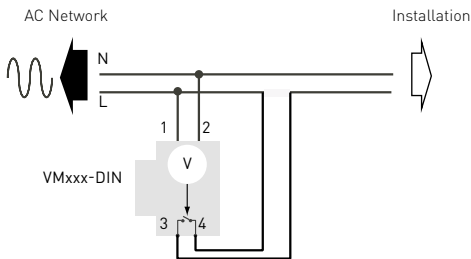

Nominal line current > 5A

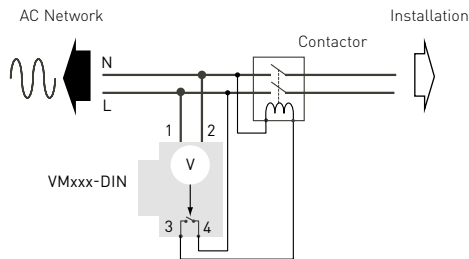



BF P AND SGP



- Isolating Spark gaps
- Outdoor or indoor application
- Discharge currents up to 150 kA
- Compliance with EN 62561-3 / IEC 62561-3

Characteristics

SGP

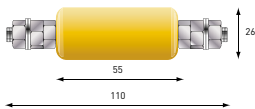

BF PS

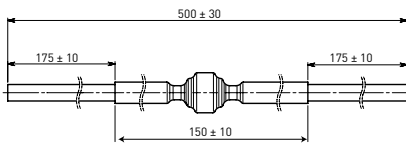

BF PC

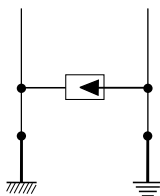
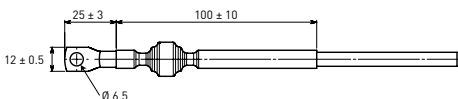

CITEL Model		BF P*	SGP70	SGP40
Description			Isolating spark gap	
Technology			Gas discharge tube	
Classification following EN 62561-3		N Class	1L Class	2L Class
Rated DC voltage withstand	$U_{w_{dc}}$	350 V	500 V	500 V
Rated AC voltage withstand	$U_{w_{ac}}$	250 Vac	350 Vac	350 Vac
Impulse Sparkover Voltage <i>(1 kV/μs)</i>	$U_{r_{imp}}$	< 1000 V	< 1500 V	< 1500 V
Max. discharge current <i>max. withstand @ 8/20 μs impulse</i>	I_{max}	150 kA	70 kA	40 kA
Impulse current <i>max. withstand 10/350 μs impulse</i>	I_{imp}	50 kA	25 kA	10 kA
Mechanical characteristics				
Dimensions		see diagrams		
* Connection to Network		wire (BF PS) wire terminal (BF PC)	threaded rod M10	threaded rod M10
Operating temperature		-40/+85°C		
Outdoor application		yes		
Protection rating		IP67	IP54	IP54
Standards				
Compliance		EN 62561-3 / IEC 62561-3		
Part number				
		BF PC 500/20 : 90231522 BF PS 500V : 90231622	690103	690102

LSC-A



- Lightning current counter
- For LPS and SPD
- Outdoor or indoor application
- Mounting on conductor or DIN rail
- Compliance with EN 62561-6

Characteristics

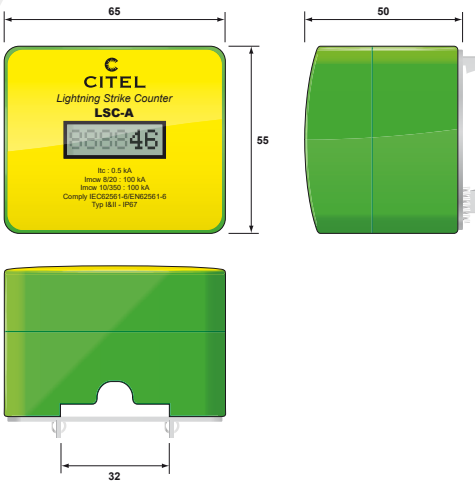

CITEL model	LSC-A
Description	Lightning current counters outdoor or indoor
Minimum current sensibility	0.5 kA
Max. admissible impulse current	100 kA
Maximum numbers of events	999999
Type d'affichage	LCD
Dimensions	66 x 55 x 47 mm
Weight	0,14 kg
Enclosure	Thermoplastic UL94 V-0
Power supply	internal by battery
Life expectancy (before battery replacement)	> 10 years
Mounting	by flange on round (diam. 10-16mm) or flat (30 x2mm) conductor or DIN rail
Protection rating	IP67
Standards	
Compliance	EN 62561-6
Part Number	
LSC-A	790121
LSC-A/DIN	790122

Installation

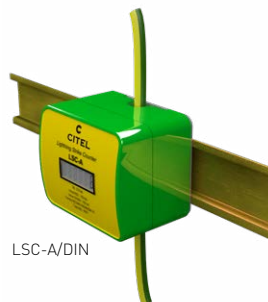

LSC-B

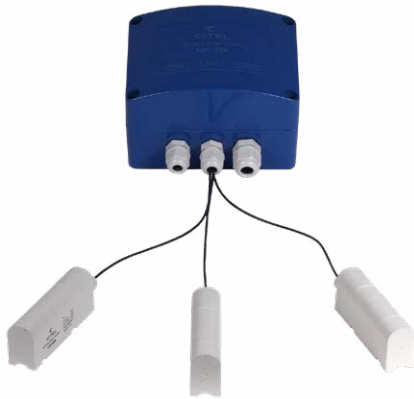

- Lightning counter for wind turbine
- 1 monitor + 3 sensors for the blades
- Precision: the counting is done by pale
- IEC 61400-24 and IEC 62561-6 compliant

Characteristics

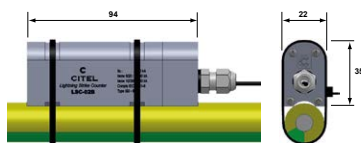

CITEL model	LSC-B	
Description	Lightning current counters for windturbine	
Max. load current	IL	600 mA
Minimum current sensibility	I _{tc}	1000 A
Max. admissible impulse current	I _{mcw}	200 kA
Mechanical characteristics		
Mounting	Feedthrough	
Operating temperature	-40°C bis + 70°C	
Protection rating	IP67	
Life expectancy	10 years	
Standards		
Compliance	IEC 61400-24 / IEC 62561-6	
Part Number		
	7901111	

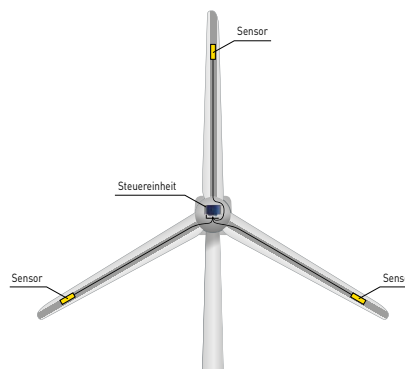

SPT-203



- Surge Protectors Tester
- Testing the MOV, GDT and TVS components
- Automatically test and judge CITEL pluggable Surge Protectors
- Auto test mode and manual test mode
- Automatically save test data
- 7-inch TFT display with touch-screen
- Database management
- Portable and convenient

Characteristics

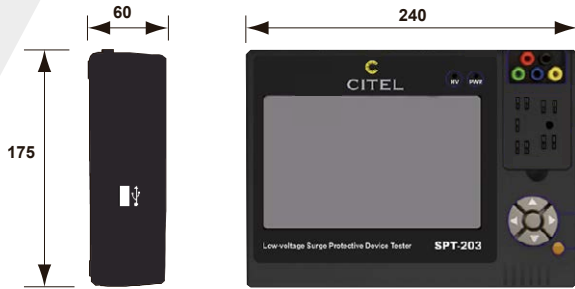

CITEL model	SPT-203
Charge voltage	AC 230 Vac single phase
Power	< 16 W
Voltage measurement error	+/- 2% (U < 200 V) +/- 1% (U > 200 V)
Leakage current measurement error	+/- 5%
MOV measurement	
1 mA voltage range	1 to 2000 V
Leakage current range	0 µA to 120 µA
GDT measurement	
DC spark voltage range	1 to 2000 V
TVS measurement	
Voltage range	0 to 500 V
Surge Protector measurement	
CITEL range : Automatic test of pluggable module	- AC Type 2/3 SPD: DAC50, DAC50VG, DS10, DS40, DS40VG, DS70R - AC compact Type 2/3 SPD : DAC15C, DAC40C, DS215, DS240, DS415, DS440 - AC Type 1/2 SPD: DAC1-13, DAC1-13VG, DS130R, DS130 VG - PV Type 2 SPD: DS50PV, DS50VGPV - Dataline SPD: DLA

OBSTRUCTION LIGHTS



- Low, Medium and High Intensity
- Led or Neon technology
- IACO, FAA compliance
- Balisor and Spherical marker range

POWERLINE



TELECOM



CHIMNEY



AIRPORT



WINDTURBINE



CRANE



Company history

OBSTA, a subsidiary of CITEL group is part of an industrial group that engineers, manufactures and sells obstruction lights for transmission lines, telecom, broadcasting towers and all kind of obstacle to air navigation since more than 30 years. Our obstruction lights are manufactured by us compliant with ICAO annex 14 chapter 6 (International Civil Aviation Organization) recommendations and the FAA (Federal Aviation Administration). OBSTA has manufacturing facilities in France and has sales offices located in France, Germany, USA, and China through Citel.

USA, Texas



FRANCE, Oil and Gas Chimney

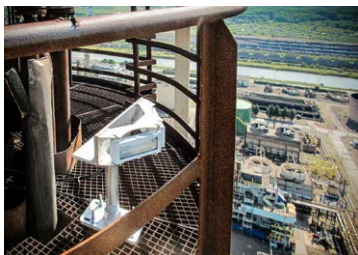

PARIS, Eiffel Tower

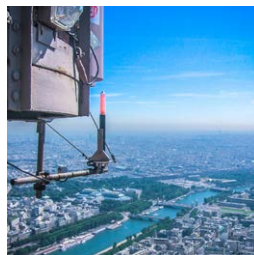

FRANCE, Millau



Paris Airport, FRANCE. Working since 1973!



BELGIUM, Bruxelles airport

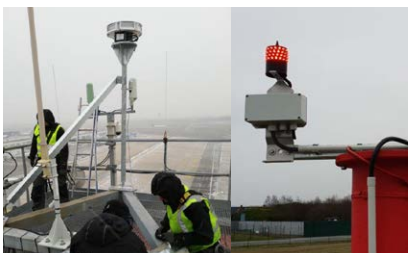

RUSSIA, Moscow



CHINA, Hong Kong



NIGERIA, Lagos, Eko Tower



MALAYSIA, Kuala Lumpur

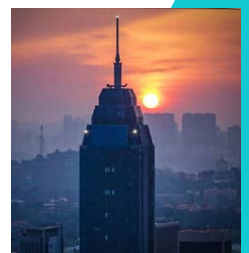

По вопросам продаж и поддержки обращайтесь:

Алматы (7273)495-231	Казань (843)206-01-48	Новокузнецк (3843)20-46-81	Смоленск (4812)29-41-54
Архангельск (8182)63-90-72	Калининград (4012)72-03-81	Новосибирск (383)227-86-73	Сочи (862)225-72-31
Астрахань (8512)99-46-04	Калуга (4842)92-23-67	Омск (3812)21-46-40	Ставрополь (8652)20-65-13
Барнаул (3852)73-04-60	Кемерово (3842)65-04-62	Орел (4862)44-53-42	Сургут (3462)77-98-35
Белгород (4722)40-23-64	Киров (8332)68-02-04	Оренбург (3532)37-68-04	Тверь (4822)63-31-35
Брянск (4832)59-03-52	Краснодар (861)203-40-90	Пенза (8412)22-31-16	Томск (3822)98-41-53
Владивосток (423)249-28-31	Красноярск (391)204-63-61	Пермь (342)205-81-47	Тула (4872)74-02-29
Волгоград (844)278-03-48	Курск (4712)77-13-04	Ростов-на-Дону (863)308-18-15	Тюмень (3452)66-21-18
Вологда (8172)26-41-59	Липецк (4742)52-20-81	Рязань (4912)46-61-64	Ульяновск (8422)24-23-59
Воронеж (473)204-51-73	Магнитогорск (3519)55-03-13	Самара (846)206-03-16	Уфа (347)229-48-12
Екатеринбург (343)384-55-89	Москва (495)268-04-70	Санкт-Петербург (812)309-46-40	Хабаровск (4212)92-98-04
Иваново (4932)77-34-06	Мурманск (8152)59-64-93	Саратов (845)249-38-78	Челябинск (351)202-03-61
Ижевск (3412)26-03-58	Набережные Челны (8552)20-53-41	Севастополь (8692)22-31-93	Череповец (8202)49-02-64
Иркутск (395)279-98-46	Нижний Новгород (831)429-08-12	Симферополь (3652)67-13-56	Ярославль (4852)69-52-93
Россия (495)268-04-70	Киргизия (996)312-96-26-47	Казахстан (7172)727-132	